

# KROMO

TABLE  
KI4410

REV  
04

## DISHWASHER K50-K80

From serial number 99016443

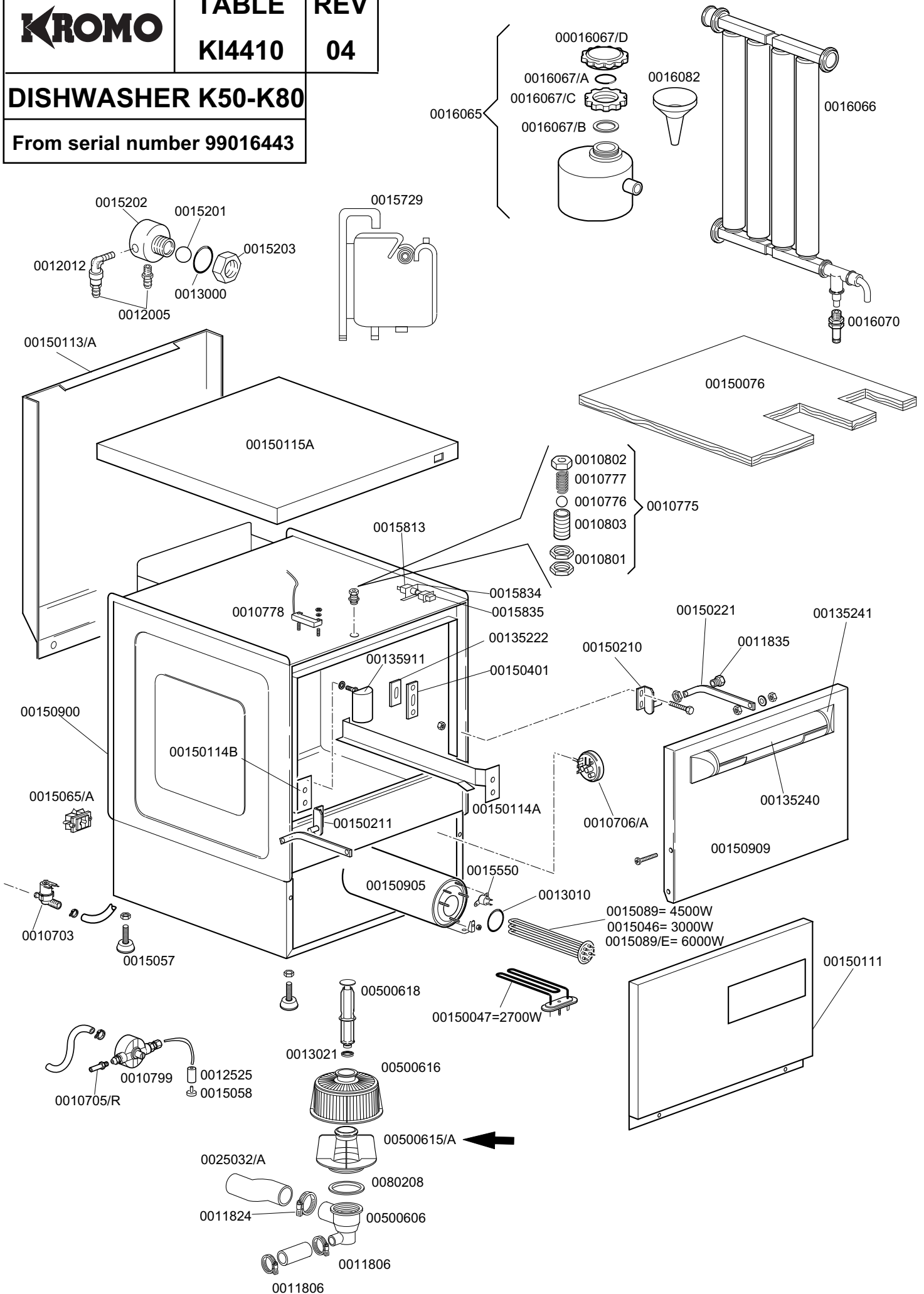

**DISHWASHER K50 - K80**

**TABLE  
KI4410**

<b>CODE</b>	<b>DESCRIPTION</b>	<b>CODE</b>	<b>DESCRIPTION</b>
0010703	220v entry solenoid valve	0016070	Complete no-return valve
0010705/R	8d. pipe fitting	0016082	Funnel
0010706/A	EL pressure switch	0025032/A	Coupling for suction K50
0010775	Brass door hook	00500606	/A right floor drain grey
0010776	D. 9.52 stainless steel ball	00500615/A	/A ferrule with filter - grey
0010777	Spring for door hook	00500616	Filter for suction
0010778	Reed magnetic microswitch	00500618	Overflow device
0010799	Shinig product dosing device 1000	0080208	Ramp seal 95x75x3
0010801	Door jack nut	0016067/C	Salt container ferrule
0010802	Door jack locknut		
0010803	Door jack body		
0011806	25/40 stainless steel clamps		
0011824	50/70 clamps		
0011835	Brass bush		
0012005	1/4 rubber-holder for 10 d. pipe		
0012012	Elbow pipe fittin 1/4 brass		
0012525	Counter-weight for small filter		
0013010	OR heating element gasket		
0013021	DEM 40 gasket		
00135222	Beating door		
00135240	Handle door in plastic		
00135241	Ending of handle K		
00135911	Complete air trap		
00150047	Tube al. resistance 2.7 KW 230v		
00150076	Polystirene coat K 50		
00150111	Lower door K 50		
00150113/A	Dorsal panel K 50		
00150114A	Right guide for basket		
00150114B	Left guide for basket		
00150115A	Lid for K 50		
00150210	Right hinge door		
00150211	Left hinge door		
00150221	Door rod 50		
00150401	Guide for bent rod		
0015046	3 Kw boiler heating element		
0015057	50 d. M10x35 small black foot		
0015058	Small shining product suction filter		
0015065/A	Cable fastener with screw		
0015089	4,5 Kw boiler heating element		
00150900	Complete body K 50		
00150905	Boiler mod. 50		
00150909	Complete door K 50		
0015201	17d. teflon DVGW safety sphere valve		
0015202	40x33 d. DVGW brass pipe fitting		
0015203	30 DVGW brass nut for pipe fitting		
0015550	Conveyor safety thermostat		
0015729	2,5 lt. break tank		
0015813	16A unipolar switch elec.component		
0015834	Start switch		
0015835	Square start push button		
0016065	Salt container		
0016066	1 liter 4 element decalcifier		
0016067/A	OR for salt container plug		
0016067/B	Salt container gasket		
0015089/E	6 Kw boiler heating element		
0016067/D	Salt container plug		



**DISHWASHER K50-K80**

**TABLE  
KI4420**

<b>CODE</b>	<b>DESCRIPTION</b>	<b>CODE</b>	<b>DESCRIPTION</b>
0010703	220v entry solenoid valve	0016066	Water softner 4 elements
0010705/R	8d. pipe fitting	0015834	Start switch
0010706/A	EL pressure switch	0015835	Square start push button
0010775	Brass door hook	0016065	Salt container
0010776	D. 9.52 stainless steel ball	0016067/A	OR Gasket for salt container plug
0010777	Spring for door hook	0016067/B	Salt container gasket
0010778	Reed magnetic microswitch	0016067/C	Ring nut for salt container
0010799	Shinig product dosing device 1000	0016067/D	Salt container plug
0010801	Door jack nut	0016070	Check valve
0010802	Door jack locknut	0016082	Funnel
0010803	Door jack body	0025032/A	Coupling for suction K50
0011806	25/40 stainless steel clamps	00500606/A	Right floor drain grey
0011824	50/70 clamps	00500615/A	Ferrule with filter - grey ←
0011835	Brass bush	00500616	Filter for suction
0012005	1/4 rubber-holder for 10 d. pipe	00500618	Overflow device
0012012	Elbow pipe fittin 1/4 brass	0080208	Ramp seal 95x75x3
0012525	Counter-weight for small filter		
0013000	OR 3125 gasket		
0013010	OR heating element gasket		
0013021	DEM 40 gasket		
00135222	Beating door		
00135240	Handle door in plastic		
00135241	Ending of handle K		
00135911	Complete air trap		
00150047	Tube al. resistance 2.7 KW 230v		
00150076	Polystirene coat K 50		
00150111	Lower door K 50		
00150113/A	Back		
00150114A	Right guide for basket		
00150114B	Left guide for basket		
00150115A	Lid for K 50		
00150210	Right hinge door		
00150211	Left hinge door		
00150221	Door rod 50		
00150313	K50 single net filter		
00150401	Guide for bent rod		
0015046	3 Kw boiler heating element		
0015057	50 d. M10x35 small black foot		
0015058	Small shining product suction filter		
0015065/A	Cable fastener with screw		
0015089	4,5 Kw boiler heating element		
0015089/E	6 Kw boiler heating element		
00150900	Complete body K 50		
00150905	Boiler mod. 50		
00150909	Complete door K 50		
00150922	Side filter stand		
00150923	Central filter stand		
0015100	Booster pump		
0015108	Eletrrical dosing device		
0015101	220-240v drain pump		
0015201	17d. teflon DVGW safety sphere valve		
0015202	40x33 d. DVGW brass pipe fitting		
0015203	30 DVGW brass nut for pipe fitting		
0015550	Conveyor safety thermostat		
0015729	2,5 lt. break tank		
0015813	16A unipolar switch elec.component		





<b>KROMO</b>	<b>TABLE</b>	<b>REV</b>
	<b>KI4460</b>	<b>04</b>
<b>DISHWASHER K 50-80</b>		
<b>From serial number 99028514</b>		

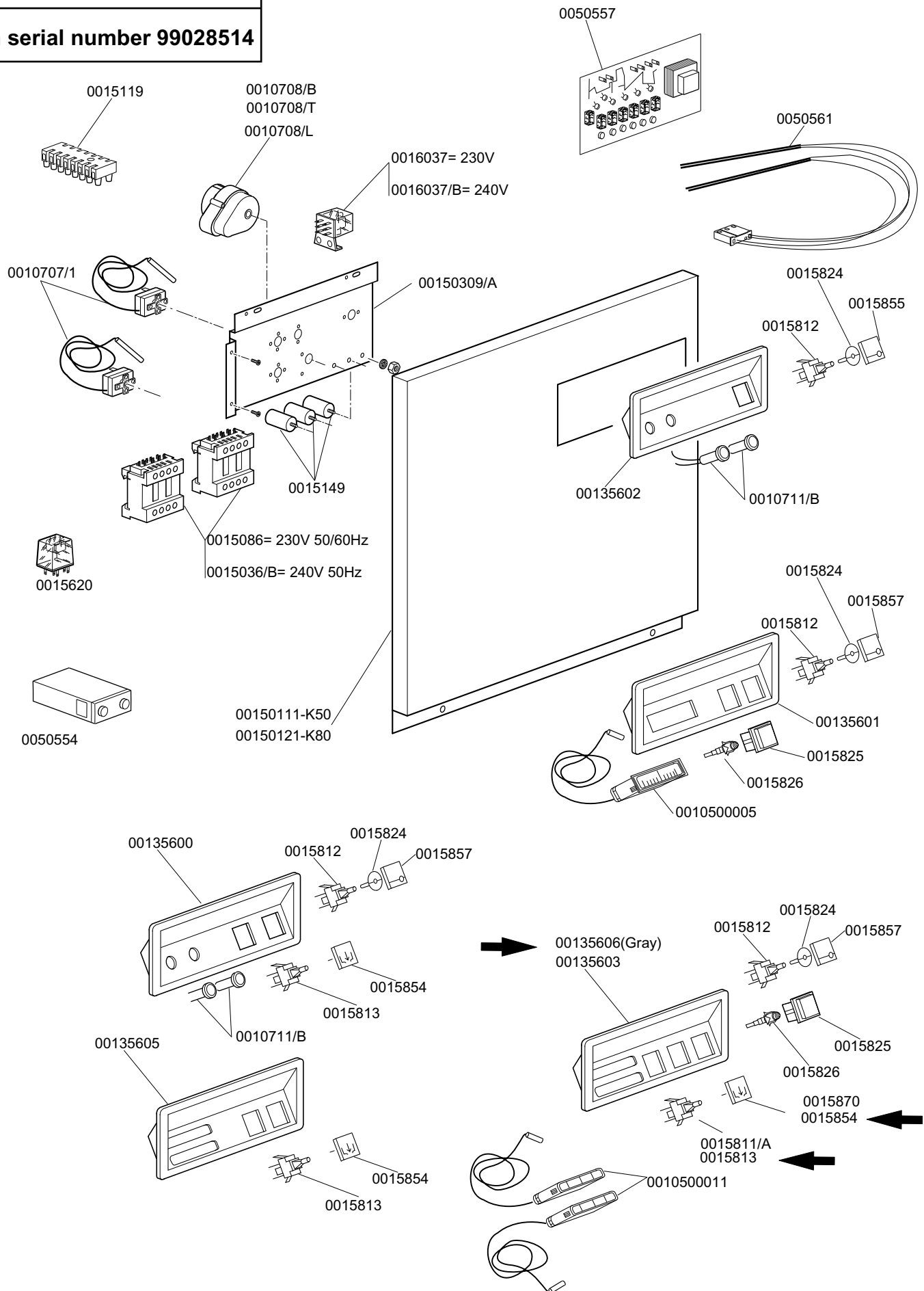



<b>KROMO</b>	<b>TABLE</b>	<b>REV</b>
	<b>KI4461</b>	<b>00</b>
<b>DISHWASHER K 45-50-80</b>		

REGENERATION / DRAIN PUMP VERSION

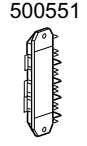
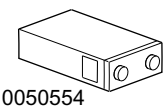
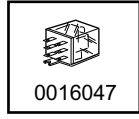

0010708/B  
0010708/T  
0010708/L

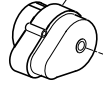

0016037= 230V  
0015620=220/240V



0050557

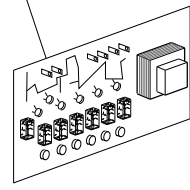

0050559

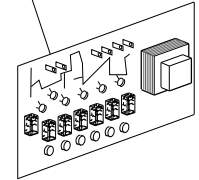

0050562

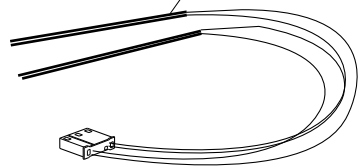

0010707/1

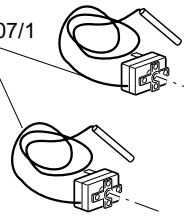

00150309/A

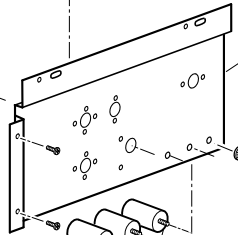

0015149

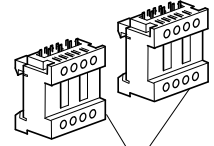

0015086= 230V 50/60Hz  
0015086/B= 240V 50Hz

00150111-K50  
00150121-K80

00135606/A(Gray)  
00135603/A  
00135616

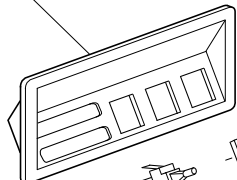

0015812 0015824 0015874

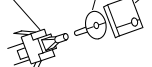

0015825

0015826

0015870  
0015854



0015811/A  
0015813

0015880

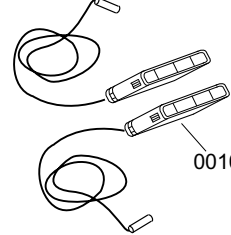

0010500011

STANDARD CONTROL PANEL K-45/50/80

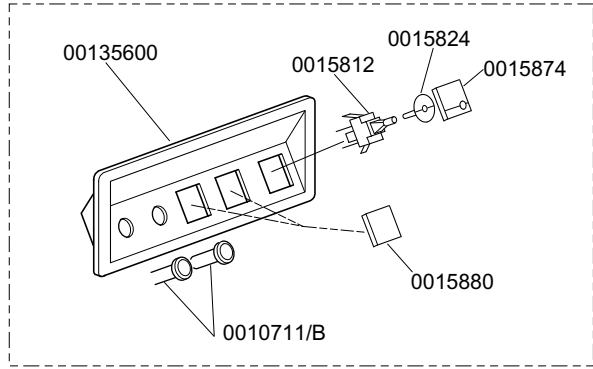

0015812 0015824 0015874

0015812

0015824

0015874

0015880

0015854 0015858

0015813

0015813

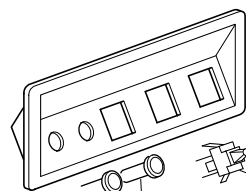

00135600

0010711/B