

Snackgeräte Crepieren

Artikel-Nr. 223005 (C35TS), 223006 (C35TD)

Explosionszeichnung / Ersatzteile

Bitte bei Ersatzteilbestellung immer Seriennummer mit angeben!

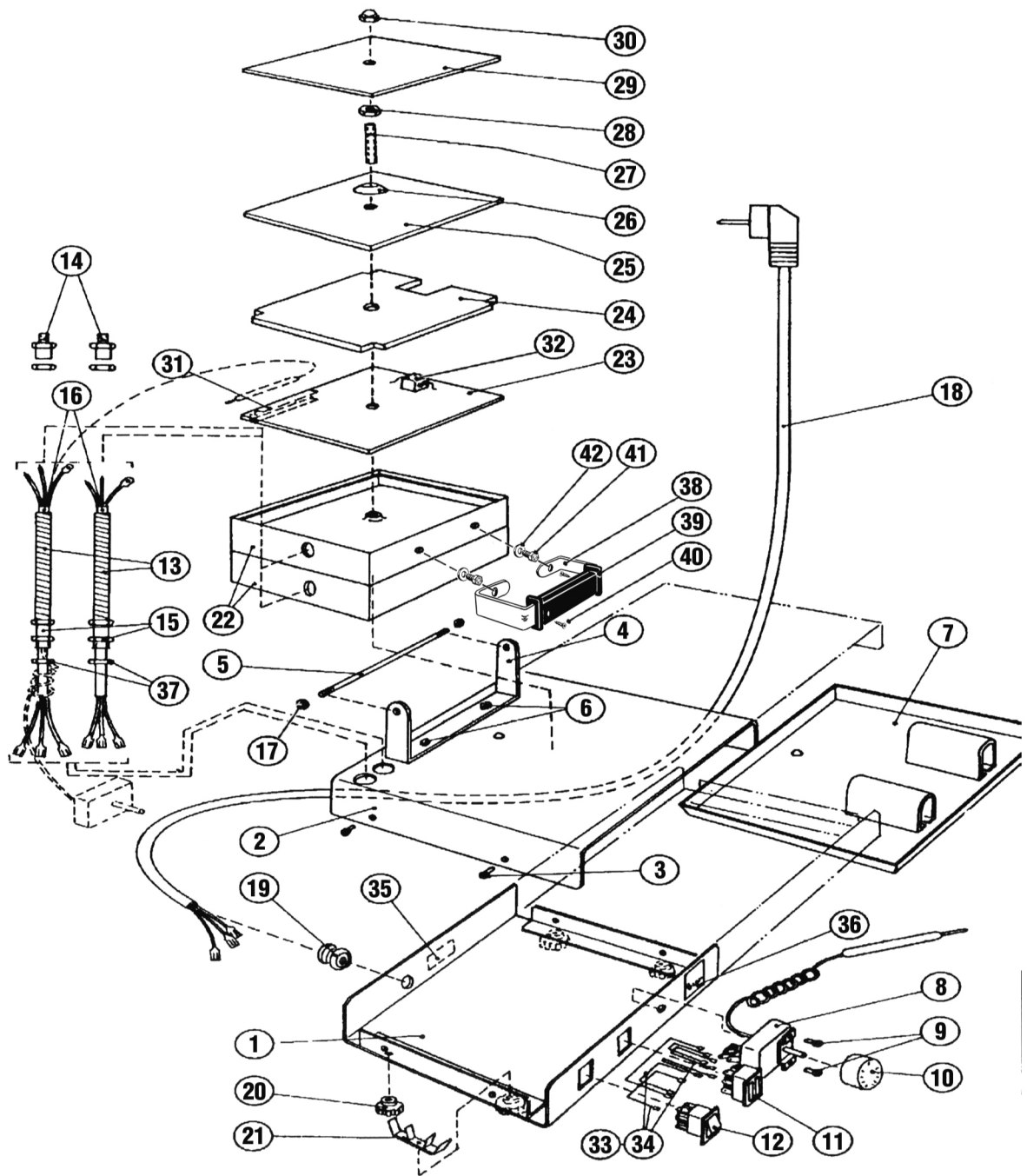















111RTS	112RTS	119RTS	122RTS	123RTS	124RTS	100TS	102TS	104TS	104FTS	106TS	106FTS	112TS	115TS	125TS	126TS
--------	--------	--------	--------	--------	--------	-------	-------	-------	--------	-------	--------	-------	-------	-------	-------





1 Fond Inox	1	6300	6300	6300	6300	6300	6300	6310	6310	6310	6310	6310	6310	6310	6310	6310	Boden, Edelstahl	
2 Couvercle Inox	1	6301	6301	6301	6301	6301	6301	6311	6311	6311	6311	6311	6311	6311	6311	6311	Deckel, Edelstahl	
3 Vis de fixation	6	1810	1810	1810	1810	1810	1810	1810	1810	1810	1810	1810	1810	1810	1810	1810	Befestigungsschraube	
4 Support charnière	1	6384	6385	6387	6388	6388	6389	6380	6381	6382	6382	6383	6383	6385	6386	6382	6381	Scharnierwinkel
5 Axe complet	1	3014	3019	3014	3017	3017	301	3017	3019	3016	3016	3015	3015	3019	3014	3016		Achse
6 Vis support	2	1180	1180	1180	1180	1180	1180	1180	1180	1180	1180	1180	1180	1180	1180	1180	1180	Schraube
7 Plateau Inox	2	6302	6302	6302	6302	6302	6302	6302	6302	6302	6302	6302	6302	6303	6302	6302	6302	Edelstahlauffangbehälter
8 Thermostat 320°C	1	6420	6420	6420	6420	6420	6420	6420	6420	6420	6420	6420	6420	6420	6420	6420	6420	Thermostat 320°C
9 Vis	2	1140	1140	1140	1140	1140	1140	1140	1140	1140	1140	1140	1140	1140	1140	1140	1140	Schraube
10 Bouton	1	6491	6491	6491	6491	6491	6491	6491	6491	6491	6491	6491	6491	6491	6491	6491	6491	Knopf
11 Lampe témoin double	1	6447	6447	6447	6447	6447	6447	6447	6447	6447	6447	6447	6447	6447	6447	6447	6447	Doppelte Kontrolleuchten
12 Interrupteur lumineux	1	6448	6448	6448	6448	6448	6448	6448	6448	6448	6448	6448	6448	6448	6448	6448	6448	Schalter, leuchtend
13 Gaine	2	6476	6476	6476	6476	6476	6476	6476	6476	6476	6476	6476	6476	6476	6476	6476	6476	Hülle
14 Embout fixe	2	6471	6471	6471	6471	6471	6471	6471	6471	6471	6471	6471	6471	6471	6471	6471	6471	Festes Ansatzstück
15 Embout fixe	2	6471	6471	6471	6471	6471	6471	6471	6471	6471	6471	6471	6471	6471	6471	6471	6471	Festes Ansatzstück
16 Cable FV	2	6477	6477	6477	6477	6477	6477	6477	6477	6477	6477	6477	6477	6477	6477	6477	6477	Kabel FV
17 Ecrou borgne	2	2556	2556	2556	2556	2556	2556	2556	2556	2556	2556	2556	2556	2556	2556	2556	2556	Rundkopfmutter
18 Cordon raccordement:																		Netzanschlussschnur
Norme CE (EU)	1	6478	6478	6478	6478	6478	6478	6478	6478	6478	6478	6478	6478	6478	6478	6478	6478	CE Norm (EU)
Norme US	1	6479	6479	6479	6479	6479	6479	-----	-----	-----	-----	-----	-----	-----	-----	-----	-----	US Norm (USA)
Norme BS	1	6480	6480	6480	6480	6480	6480	-----	-----	-----	-----	-----	-----	-----	-----	-----	-----	BS Norm
19 Passe cable		-----	-----	-----	-----	-----	-----	-----	-----	-----	-----	-----	-----	-----	-----	-----	-----	Kabeldurchführungsgummi
20 Pieds	4	6406	6406	6406	6406	6406	6406	6406	6406	6406	6406	6406	6406	6406	6406	6406	6406	Füsse
21 Cosse terre	1	6475	6475	6475	6475	6475	6475	6475	6475	6475	6475	6475	6475	6475	6475	6475	6475	Erdanschlussklemme
22 Corps en fonte	2	6561	6562	6569	6572	6573	6574	6550	6552	6553	6554	6556	6557	6562	6565	6575	6576	Körper aus Gusseisen
23 Résistances 220-250 V	2	6111	6112	6119	6122	6123	6124	6102	6102	6104	6104	6106	6106	6112	6115	6104	6126	Resistenz 220-250 V
23 Résistances 110-120 V	2	6211	6212	6219	6222	6223	6224	-----	-----	-----	-----	-----	-----	-----	6213	-----	6226	Resistenz 110-120 V
24 Isolant thermique	2	3461		3469	3472	3473	3474	3450	3450	3453	3453	3456	3456	3462	3465	3453		Wärmeisolator
25 Plaque de pression	2	3256		3258	3253	3259	3260	3251	3251	3252	3252	3253	3253	3258	3255	3258		Gegengewichtsplatte
26 Rondelle de pression	2	3116	3116	3116	3116	3116	3116	3116	3116	3116	3116	3116	3116	3116	3116	3116	3116	Gegengewichtsdruckscheibe
27 Goujon fileté	2	3084		3081	3080	3081	3081	3082	3080	3082	3082	3083	3083	3083	-----	3080		Stiftschraube
28 Ecrou	2	2555	2555	2555	2555	2555	2555	2555	2555	2555	2555	2555	2555	2555	2555	2555	2555	Schraubenmutter
29 Couvercle	2	3327		3329	3331	3332	3333	3320	3321	3322	3323	3325	3326	3328	3330	3322		Deckel
30 Ecrou borgne	2	2556	2556	2556	2556	2556	2556	2556	2556	2556	2556	2556	2556	2556	2556	2556	2556	Rundkopfmutter
31 Prise de température	1	6437	6437	6437	6437	6437	6437	6437	6437	6437	6437	6437	6437	6437	6437	6437	6437	Temperaturnahme
32 Borne répartition 4 visés céramic	2	2871	2871	2871	2871	2871	2871	2871	2871	2871	2871	2871	2871	2871	2871	2871	2871	Keramikklemmstein
33 Fils cablage simples	2	6438	6438	6438	6438	6438	6438	6438	6438	6438	6438	6438	6438	6438	6438	6438	6438	Einzelkabel mit Kosse
34 Fils cablage doubles	2	6435	6435	6435	6435	6435	6435	6435	6435	6435	6435	6435	6435	6435	6435	6435	6435	Doppelkabel mit Kosse
35 Plaque matricule	1	6439	6439	6439	6439	6439	6439	6439	6439	6439	6439	6439	6439	6439	6439	6439	6439	Kenn-Nummerplatte
36 Plaque LUXINOX	1	6490	6490	6490	6490	6490	6490	6490	6490	6490	6490	6490	6490	6490	6490	6490	6490	Luxinoxschild
37 Contre écrou	2	6473	6473	6473	6473	6473	6473	6473	6473	6473	6473	6473	6473	6473	6473	6473	6473	Gegenmutter
38 Cadre Inox pour gaufrier	2	3113	3113	3113	3113	3113	3113	3113	3113	3113	3113	3113	3113	3113	3113	3113	3113	Edelstahlhalter für Griff
39 Poignée gaufrier (Pièce plastique)	4	6351	6351	6351	6351	6351	6351	6351	6351	6351	6351	6351	6351	6351	6351	6351	6351	Plastik Griff
40 Vis de fixation	4	1810	1810	1810	1810	1810	1810	1810	1810	1810	1810	1810	1810	1810	1810	1810	1810	Befestigungsschraube
41 Vis support	4	1180	1180	1180	1180	1180	1180	1180	1180	1180	1180	1180	1180	1180	1180	1180	1180	Schraube
42 Rondelle isolant	4	2099	2099	2099	2099	2099	2099	2099	2099	2099	2099	2099	2099	2099	2099	2099	2099	Isolierscheibe
SOUS ENSEMBLES		-----	-----	-----	-----	-----	-----	-----	-----	-----	-----	-----	-----	-----	-----	-----	-----	
Socle inox vide		6305	6305	6305	6305	6305	6305	6413	6413	6413	6413	6413	6413	6413	6413	6413	6413	Leeres Edelstahl Untergestell
Socle inox cablé CEE		6306	6306	6306	6306	6306	6306	6414	6414	6414	6414	6414	6414	6414	6414	6414	6414	Nach CEE verkabeltes Untergestell
Mode d'emploi et notice de recettes pour gaufrier	1	5099	5099	5099	5099	5099	5099	5099	5099	5099	5099	5099	5099	5099	5099	5099	5099	Bedienungsanleitung und Rezeptenbuch

	N°	Désignation	Dimensions L x B x H	Kg	
	PL6380	Support charnière pour gaufrier 100	190 x 20 x 73,75 mm Epaisseur: 4 mm	0,197	
	PL3017	Axe complet pour gaufrier 100	Ø 5 x 215 mm	0,032	
	PL6381	Support charnière pour gaufrier 102	180,30 x 20 x 73,75 mm Epaisseur: 4 mm	0,181	
	PL3019	Axe complet pour gaufrier 102	Ø 5 x 200 mm	0,030	
	PL6382	Support charnière pour gaufrier 104	152,45 x 20 x 80,70 mm Epaisseur: 4 mm	0,167	
	PL3016	Axe complet pour gaufrier 104	Ø 5 x 155 mm	0,023	
	PL6383	Support charnière pour gaufrier 106	170 x 20 x 79,90 mm Epaisseur: 4 mm	0,177	
	PL3015	Axe complet pour gaufrier 106	Ø 5 x 184 mm	0,028	



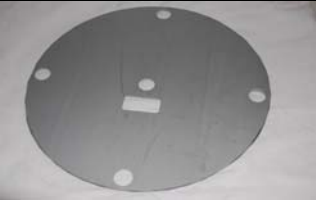





	PL6384	Support charnière pour gaufrier 111	270 x 20 x 94,06 mm Epaisseur: 4 mm	0,234	
	PL3014	Axe complet pour gaufrier 111	Ø 5 x 215 mm	0,032	
	PL6385	Support charnière pour gaufrier 112	184 x 20 x 81,48 mm Epaisseur: 4 mm	0,216	
	PL3019	Axe complet pour gaufrier 112	Ø 5 x 195 mm	0,029	
	PL6386	Support charnière pour gaufrier 115	204 x 20 x 76,54 mm Epaisseur: 4 mm	0,197	
	PL3014	Axe complet pour gaufrier 115	Ø 5 x 215 mm	0,033	
	PL6387	Support charnière pour gaufrier 119 & 129	203 x 20 x 85,17 mm Epaisseur: 4 mm	0,204	
	PL3014	Axe complet pour gaufrier 119 & 129	Ø 5 x 218 mm	0,033	
	PL6388	Support charnière pour gaufrier 122 & 123	190 x 20 x 82,79 mm Epaisseur: 4 mm	0,193	

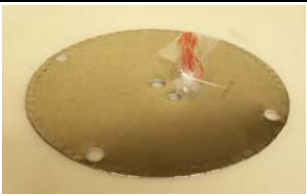
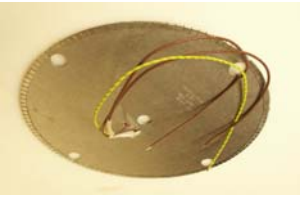

	PL3017	Axe complet pour gaufrier 122 & 123	Ø 5 x 212 mm	0,032	
	PL6389	Support charnière pour gaufrier 124	173 x 20 x 82,80 mm Epaisseur: 4 mm	0,188	
	PL3015	Axe complet pour gaufrier 124	Ø 5 x 185 mm	0,028	
	PL3251	Plaque de pression pour résistance pour gaufrier 100	168 x 164 x 3 mm	0,639	
	PL3251	Plaque de pression pour résistance pour gaufrier 102	158 x 157 x 3 mm	0,573	
	PL3252	Plaque de pression pour résistance pour gaufrier 104	141 x 134 x 3 mm	0,442	
	PL3252	Plaque de pression pour résistance pour gaufrier 104F	141 x 134 x 3 mm	0,428	
	PL3253	Plaque de pression pour résistance pour gaufrier 106F	165 x 135 x 3 mm	0,505	
	PL3256	Plaque de pression pour résistance pour gaufrier 111	210 x 179 x 3 mm	0,879	

	PL3258	Plaque de pression pour résistance pour gaufrier 119	180 x 160 x 3 mm	0,669	
	PL3253	Plaque de pression pour résistance pour gaufrier 122			
	PL3259	Plaque de pression pour résistance pour gaufrier 123	200 x 134 x 3 mm	0,624	
	PL3260	Plaque de pression pour résistance pour gaufrier 124	153 x 114 x 3 mm	0,402	
	PL3261	Plaque de pression pour résistance pour gaufrier 126+127	180 x 156 x 3 mm	0,664	
	PL3262	Plaque de pression pour résistance pour gaufrier 128			
	PL3263	Plaque de pression pour résistance pour gaufrier 129			
	PL3264	Plaque de pression pour résistance pour gaufrier 130			
	PL3270	Plaque de pression pour résistance pour crêpière C25	208 x 194 x 3 mm	0,820	

	PL3271	Plaque de pression pour résistance pour crêpière C35	320 x 225 x 18 mm Epaisseur: 3 mm	1,359	
	PL3275	Plaque de renfort pour crêpière simple C35	250 x 235 x 18,10 mm Epaisseur: 3 mm		
	PL3276	Plaque de renfort pour crêpière double C35	650 x 225 x 18 mm Epaisseur: 3 mm	3,636	
	PL3450	Isolant thermique pour gaufrier 100 + 102	184 x 157 x 3 mm	0,075	
	PL3456	Isolant thermique pour gaufrier 106 + 106F	195 x 136 x 3 mm	0,070	
	PL3462	Isolant thermique pour gaufrier 112	204 x 159 x 3 mm	0,080	
	PL3465	Isolant thermique pour gaufrier 115	273 x 230 x 3 mm	0,144	
	PL3469	Isolant thermique pour gaufrier 119	207 x 174 x 3 mm	0,092	
	PL3472	Isolant thermique pour gaufrier 122	186 x 143 x 3 mm	0,068	



	PL3473	Isolant thermique pour gaufrier 123	228 x 135 x 3 mm	0,079	
	PL3474	Isolant thermique pour gaufrier 124	181 x 113 x 3 mm	0,060	
	PL3476	Isolant thermique pour gaufrier 126+127	186 x 179 x 3 mm	0,096	
	PL3478	Isolant thermique pour gaufrier 128			
	PL3479	Isolant thermique pour gaufrier 129			
	PL3480	Isolant thermique pour gaufrier 130			
	PL3498	Isolant thermique pour crêpière C25	Ø 235 x 3 mm	0,119	
	PL6148AB	Résistance pour crêpière C25 ABATEC	Ø 235 mm		
	PL6148	Résistance pour crêpière C25 220 - 240 V	Ø 234 mm	0,106	

	PL6147AB	Résistance pour crêpière C35 ABATEC 230 V	Ø 350 mm		
	PL6147CL	Résistance pour crêpière C35 CELTIC 230 V	Ø 350 mm		
	PL6104	Résistance pour gaufrier 104 220 - 240 V	166 x 135 mm	0,047	
	PL6106	Résistance pour gaufrier 106F 220 - 240 V	202 x 135 mm	0,051	
	PL6111	Résistance pour gaufrier 111 220 - 240 V	236 x 178 mm	0,083	
	PL6115	Résistance pour gaufrier 115 220 - 240 V	276 x 204 mm	0,105	
	PL6119	Résistance pour gaufrier 119 220 - 240 V	209 x 174 mm	0,079	
	PL6122	Résistance pour gaufrier 122 220 - 240 V	190 x 143 mm	0,053	
	PL6123	Résistance pour gaufrier 123 220 - 240 V	229 x 136 mm	0,058	



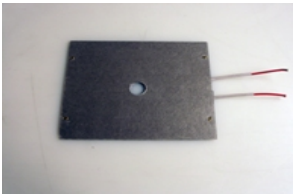
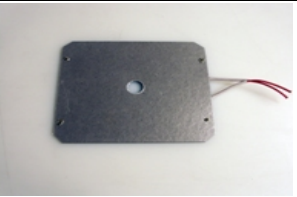
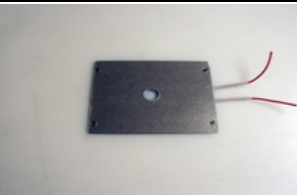
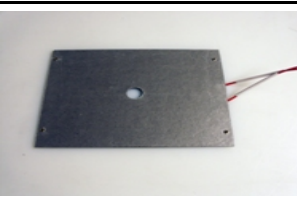
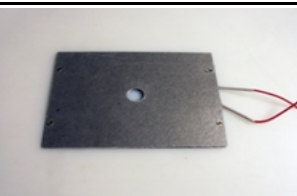
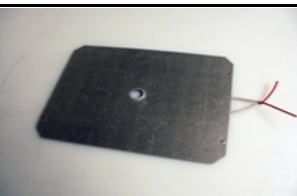

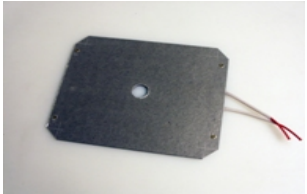
	PL6124	Résistance pour gaufrier 124 220 - 240 V	183 x 113 mm	0,037	
	PL6126	Résistance pour gaufrier 126 220 - 240 V	185 x 181 mm	0,085	
	PL6127	Résistance pour gaufrier 127 220 - 240 V			
	PL6128	Résistance pour gaufrier 128 220 - 240 V			
	PL6129	Résistance pour gaufrier 129 220 - 240 V			
	PL6130	Résistance pour gaufrier 130 220 - 240 V			
	PL6200	Résistance pour gaufrier 100 115 V			
	PL6202	Résistance pour gaufrier 102 115 V			
	PL6204	Résistance pour gaufrier 104 - F 115 V			

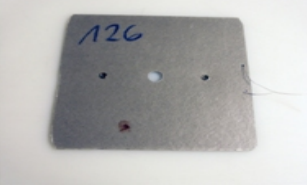
	PL6206	Résistance pour gaufrier 106 - F 115 V			
	PL6211	Résistance pour gaufrier 111 115 V			
	PL6212	Résistance pour gaufrier 112 115 V			
	PL6215	Résistance pour gaufrier 115 115 V			
	PL6219	Résistance pour gaufrier 119 115 V			
	PL6222	Résistance pour gaufrier 122 115 V			
	PL6223	Résistance pour gaufrier 123 115 V			
	PL6224	Résistance pour gaufrier 124 115 V			
	PL6226	Résistance pour gaufrier 126-127 115 V	185 x 179 mm	0,088	

	PL6228	Résistance pour gaufrier 128 115 V			
	PL6229	Résistance pour gaufrier 129 115 V			
	PL6230	Résistance pour gaufrier 130 115 V			
	PL6102AB	Résistance pour gaufrier 100 ABATEC	191 x 158 mm		
	PL6102AB	Résistance pour gaufrier 102 ABATEC	187 x 156 mm		
	PL6104AB	Résistance pour gaufrier 104 ABATEC	165 x 130 mm		
	PL6111AB	Résistance pour gaufrier 111 ABATEC	234 x 177 mm		
	PL6112AB	Résistance pour gaufrier 112 ABATEC	200 x 156 mm		
	PL6115AB	Résistance pour gaufrier 115 ABATEC	274 x 203 mm		







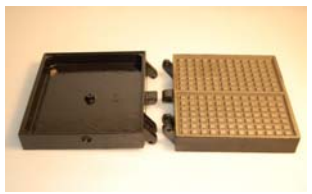

	PL6119AB	Résistance pour gaufrier 119 ABATEC	206 x 174 mm		
	PL6122AB	Résistance pour gaufrier 122 ABATEC			
	PL6123AB	Résistance pour gaufrier 123 ABATEC	228 x 136 mm		
	PL6124AB	Résistance pour gaufrier 124 ABATEC	182 x 113 mm		
	PL6126AB	Résistance pour gaufrier 126 ABATEC	184 x 177 mm		
	PL6127AB	Résistance pour gaufrier 127 ABATEC			
	PL6128AB	Résistance pour gaufrier 128 ABATEC			
	PL6129AB	Résistance pour gaufrier 129 ABATEC			
	PL6130AB	Résistance pour gaufrier 130 ABATEC			

	PL6119CA	Résistance pour gaufrier 119 CALESCO			
	PL6122CA	Résistance pour gaufrier 122 CALESCO			
	PL3320	Couvercle en inox pour gaufrier 100	199 x 171 x 1 mm	0,286	
	PL3321	Couvercle en inox pour gaufrier 102	195 x 164 x 1 mm	0,250	
	PL3322	Couvercle en inox pour gaufrier 104	178 x 144 x 1 mm	0,200	
	PL3323	Couvercle en inox pour gaufrier 104F	176 x 141 x 1 mm	0,196	
	PL3326	Couvercle en inox pour gaufrier 106F	209 x 144 x 1 mm	0,235	
	PL3327	Couvercle en inox pour gaufrier 111	243 x 186 x 1 mm	0,356	
	PL3328	Couvercle en inox pour gaufrier 112	213 x 170 x 1 mm	0,285	

	PL3329	Couvercle en inox pour gaufrier 119	214 x 180 x 1 mm	0,304	
	PL3331	Couvercle en inox pour gaufrier 122	198 x 150 x 1 mm	0,236	
	PL3332	Couvercle en inox pour gaufrier 123	234 x 142 x 1 mm	0,262	
	PL3333	Couvercle en inox pour gaufrier 124	187 x 119 x 1 mm	0,174	
	PL3334	Couvercle en inox pour gaufrier 126+127	190 x 184 x 1 mm	0,276	
	PL3335	Couvercle en inox pour gaufrier 128			
	PL3336	Couvercle en inox pour gaufrier 129			
	PL3337	Couvercle en inox pour gaufrier 130			
	PL3150	Fonte de gaufrier brute pour gaufrier 100			

	PL3152	Fonte de gaufrier brute pour gaufrier 102			
	PL3153	Fonte de gaufrier brute pour gaufrier 104			
	PL3154	Fonte de gaufrier brute pour gaufrier 104F			
	PL3156	Fonte de gaufrier brute pour gaufrier 106			
	PL3157	Fonte de gaufrier brute pour gaufrier 106F			
	PL3161	Fonte de gaufrier brute pour gaufrier 111			
	PL3162	Fonte de gaufrier brute pour gaufrier 112			
	PL3165	Fonte de gaufrier brute pour gaufrier 115			
	PL3169	Fonte de gaufrier brute pour gaufrier 119			

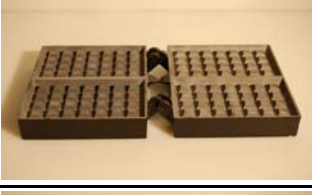
	PL3172	Fonte de gaufrier brute pour gaufrier 122			
	PL3173	Fonte de gaufrier brute pour gaufrier 123			
	PL3174	Fonte de gaufrier brute pour gaufrier 124			
	PL3176	Fonte de gaufrier brute pour gaufrier 126			
	PL3177	Fonte de gaufrier brute pour gaufrier 127			
	PL3178	Fonte de gaufrier brute pour gaufrier 128			
	PL3179	Fonte de gaufrier brute pour gaufrier 129			
	PL3180	Fonte de gaufrier brute pour gaufrier 130			
	PL6550	Corps en fonte pour gaufrier 100 - 20 x 34 2 gaufres le set de 2 pièces	206 x 180 x 33 mm	2 x 2,732	

	PL6552	Corps en fonte pour gaufrier 102 - 7x 12 2 gaufres le set de 2 pièces	203 x 172 mm	2 x 2,761	
	PL6553	Corps en fonte pour gaufrier 104 - 4 x 7 2 gaufres le set de 2 pièces	187 x 152 mm	2 x 2,563	
	PL6554	Corps en fonte pour gaufrier 104F - 4 x 7 2 gaufres le set de 2 pièces	182 x 143 mm	2 x 2,060	
	PL6556	Corps en fonte pour gaufrier 106 - 4 x 6 2 gaufres le set de 2 pièces	218 x 153 mm	2 x 3,254	
	PL6557	Corps en fonte pour gaufrier 106F - 4 x 6 2 gaufres le set de 2 pièces	218 x 153 mm	2 x 3,254	
	PL6561	Corps en fonte pour gaufrier 111 - 4 x 6 2 gaufres le set de 2 pièces	249 x 193 mm	2 x 4,585	
	PL6562	Corps en fonte pour gaufrier 112 - 4 x 7 2 gaufres le set de 2 pièces	222 x 179 mm	2 x 3,975	
	PL6562R	Corps en fonte pour gaufrier 112R - 4 x 7 2 gaufres le set de 2 pièces		2 x 4,044	
	PL6565	Corps en fonte pour gaufrier 115 - 24 x 18 1 gaufre le set de 2 pièces	289 x 218 mm	2 x 6,480	





	PL6569	Corps en fonte pour gaufrier 119 - 3 x 5 2 gaufres le set de 2 pièces	225 x 192 mm	2 x 4,678	
	PL6572	Corps en fonte pour gaufrier 122 - 4 x 6 2 gaufres le set de 2 pièces	210 x 164 mm	2 x 3,673	
	PL6573	Corps en fonte pour gaufrier 123R - 4 x 5 2 gaufres le set de 2 pièces	242 x 150 mm	2 x 3,513	
	PL6574	Corps en fonte pour gaufrier 124 - 3 x 4 2 gaufres le set de 2 pièces	196 x 128 mm	2 x 2,783	
	PL6576	Corps en fonte pour gaufrier 126 - 5 x 25 1 gaufre le set de 2 pièces	200 x 194 mm	2 x 3,196	
	PL6577	Corps en fonte pour gaufrier 127 - 4 x 23 1 gaufre le set de 2 pièces			
	PL6578	Corps en fonte pour gaufrier 128 - 2 x 126 (diamètre) le set de 2 pièces			
	PL6579	Corps en fonte pour gaufrier 129 - 4 x 8 1 gaufre le set de 2 pièces			
	PL6580	Corps en fonte pour gaufrier 130 - 4 x B 4 bâtons le set de 2 pièces			

	PL6598	Corps en fonte pour crêpière C25 - 1 crêpe	Ø 254 x 45 mm	2,997	
	PL6597	Corps en fonte pour crêpière C35 - 1 crêpe	Ø 344 x 55 mm	7,360	
	PL6302A	Plateau en inox pour gaufrier 119	300 x 225 x 13,77 mm	0,668	
	PL6302B	Plateau en inox pour gaufrier 115	300 x 225 x 13,77 mm	0,668	
	PL6302C	Plateau en inox pour gaufrier 122	300 x 225 x 13,77 mm	0,664	
	PL6302D	Plateau en inox pour gaufrier 124	300 x 225 x 13,77 mm	0,664	
	PL6302E	Plateau en inox pour gaufrier 129			
	PL	Nez pour plateau PL6302C	47 x 39 x 29 mm	0,035	
	PL	Nez pour plateau PL6302A	75 x 39 x 29 mm	0,056	

	PL	Nez pour plateau PL6302B	73 x 40 x 33 mm	0,053	
	PL6476I	Gaine en inox	Ø 14,90 mm Longueur 270 mm	0,031	
	PL9476I	Gaine complet, en inox	Ø 14,90 mm Longueur: 280 mm	0,062	
	PL6476	Gaine en galvan	Ø 14,90 mm Longueur: 270 mm	0,040	
	PL9476	Gaine complet, en galvan	Ø 14,90 mm Longueur: 280 mm	0,069	
	PL6471	Embout fixe	Ø: 19,04 mm Longueur: 19,45 mm	0,015	
	PL6448A	On / Off interrupteur lumineux ENEC	Largeur: 24,75 mm Hauteur: 32 mm	0,018	
	PL6448B	On / Off interrupteur lumineux UL/CSA/ENEC	22 x 30 mm	0,014	
	PL6447	Lampe témoin double pour 200-250 V UL/CSA/ENEC	Largeur: 24,75 mm Hauteur: 31,50 mm	0,012	

	PL6447UL	Lampe témoin double pour 110 V UL/CSA/ENEC	Largeur: 32 mm Hauteur: 25 mm	0,010	
	PL6491A	Bouton tournant pour température EGO	Ø 50 mm	0,008	
	PL6491B	Bouton tournant pour température	Ø 50 mm	0,008	
	PL6491C	Bouton tournant pour température CAEM	Ø 50 mm	0,009	
	PL TMR15E-A	Compteur à rebours digitale			
	PLB252.2	Compteur d'heure d'utilisation électro mécanique	47,90 x 24 mm	0,040	
	PL6420A	Thermostat 320°C EGO	Longueur: 162 mm	0,076	
	PL6420B	Thermostat CAEM 300 °C		0,102	
	PL2871	Borne répartition 4 vises céramic	23,43 x 20 mm	0,016	





	PL6427	Rivet fixation pied	Ø : 5,82 mm Longueur: 10,69 mm	0,001	
	PL6406	Pied	Ø : 16,89 mm	0,001	
	PL9001	Pied complet avec rivet fixation pied	Ø : 16,89 mm	0,002	
	PL6475	Cosse terre	Longueur: 26,87 mm	0,001	
	PL3116	Rondelle de pression	Ø : 30,22 mm	0,011	
	PL6700	Socle travers 220V CE	58,25 x 26,53 mm	0,014	
	PL6437	Prise de température	109,38 x 23,25 x 16,40 mm	0,031	
	PL9100	Refort interne pour gaufrier	185 x 33,70 x 48,40 mm	0,121	
	PL2556	Ecrou borgne 1587 (M5)	Ø 7,95 mm Longueur: 9,97 mm	0,002	





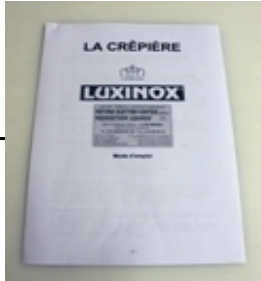



	PL1001	Vis à tête cylindrique avec hexagone intérieur DIN912A2 (5 x 16)	Ø 5 mm Longueur: 16 mm	0,003	
	PL1810	Vis de fixation ISO10642A2 (M3 x 10)	Ø 3 mm Longueur: 10 mm	0,001	
	PL1016	Goujon fileté à souder pour fixation de la masse M4 x 10 PT en ISO13918			
	PL1180	Vis de fixation pour poignée DIN933A2	Ø 6 mm Longueur: 14 mm	0,004	
	PL2560	Ecrou à souder DIN929A2BL - M6	Ø 10,82 mm	0,002	
	PL1003	Ecrou hexagonal DIN934 - M5	Ø 7,88 mm	0,001	
	PL1004	Ecrou hexagonal M4 (fixation masse)	Ø 6,89 mm	0,001	
	PL1005	Ecrou à souder DIN929 - M3 (pour souder au fond, pour fixation couvercle)	Ø 7,37 mm	0,001	
	PL1006	Vis	Ø 2,89 mm Longueur: 12,83 mm	0,001	









	PL1007	Rondelle de sécurité pour fixation masse	Ø 7,97 mm	0,001	
	PL1008	Rondelle DIN125A2	Ø 9,86 mm	0,001	
	PL1009	Rivet creux en laiton	Ø 5 mm	0,001	
	PL1010	Isolant en mécanique	60,62 x 59,79 mm	0,002	
	PL1140	Vis pour fixation thermostat DIN7985 M4 x 4	Ø 4 mm Longueur: 7,02 mm	0,001	
	PL1011	Vis 3 x 16 mm	3 x 16 mm	0,001	
	PL1012	Cosse M5 1/2,5 108007	Ø 8,73 mm Longueur: 19,03 mm	0,001	
	PL1013	Cosse	Longueur: 17,77 mm		
	PL2099	Rondelle isolant	Ø 15,02 mm	0,001	





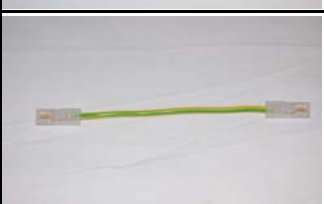

	PL3081	Vis pointeau 6 pans creux bout plat	Ø 5 mm Longueur: 30 mm	0,003	
	PL3080	Vis pointeau 6 pans creux bout plat DIN913 45A M5 x 35)	Ø 5 mm Longueur: 35 mm	0,004	
	PL3084	Vis pointeau 6 pans creux bout plat	Ø 5 mm Longueur: 40 mm	0,005	
	PL6473	Contre écrou	Ø 17,91 mm	0,003	
	PL1013	Spacer MF hex M5 x H8 x L18	18 x 5 x 8 mm	0,007	
	PL1014	Spacer MF hex M5 x H8 x L25	25 x 5 x 8 mm	0,010	
	PL1023	Contre écrou pour porte fusible	Ø 15,88 mm	0,001	
	PL1020	Porte fusible	Ø 15,07 mm Longueur: 34,10 mm	0,003	
	PL1024	Fusible	Ø 5,18 mm Longueur: 20 mm	0,001	







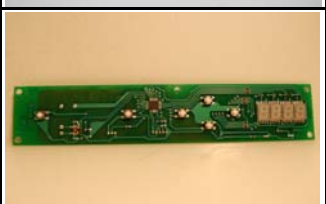
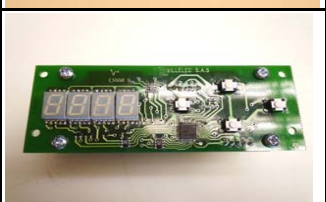
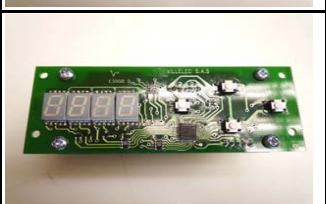

	PL1021	Fermeture porte fusible	Ø 9,42 mm Longueur: 18 mm	0,002	
	PL1022	Joint porte fusible	Ø 15,70 mm		
	PL9002	Porte fusible, set complet sans fusible	Longueur: 34,16 mm	0,007	
	PL1023	Passe cable M25	Ø 25,5 mm Hauteur: 21,30 mm	0,009	
	PL9050	Pièce à distance en métal für C35TS & TD	Ø 140 mm	1,576	
	PL3113	Cadre en inox pour gaufrier	155 x 20,19 x 2,75 mm	0,145	
	PL6351	Poignée en plastique (Pour faire un complet poignée, on a besoin 2)	139,65 x 35,52 x 8,74 mm	0,029	
	PL9030	Poignée complet	156 x 290 mm	0,206	
	PL 5099A	Mode d'emploi et notice de recettes			

	PL5099A	notice de recettes pour gaufrier			
	PL5099B	Mode d'emploi pour crêpière			
	PL5099C	Mode d'emploi et notice de recettes pour gaufrier version N			
	PL5099D	Mode d'emploi et notice de recettes pour gaufrier version C			
	PL6439	Plaque matricule	90 x 45 mm		
	PL6490A	Plaque Luxinox	80 x 33 mm	0,004	
	PL6490B	Indicateur pour température pour toute serie T	22 x 4 mm		
	PL6490C	Autocollant partie frontale RNS, NS & C25NS	295 x 47 mm	0,007	





	PL6490D	Autocollant partie frontale C35NS	395 x 47 mm	0,010	
	PL6490E	Autocollant partie frontale RCS, CS & C25CS			
	PL6481	Cable CE norme		0,362	
	PL6482	Cable CE norme	Longueur: 800 mm	0,132	
	PL6478	Cordon raccordement CE norme		0,431	
	PL6477	Cable CE norme	Longueur: 800 mm	0,061	
	PL6438R	Cable rouge CE norme	148,70 x 9,30 mm	0,006	
	PL6435	Cable rouge double CE norme	151,44 x 9,10 mm	0,011	
	PL6438VJ	Cable vert - jaune CE norme	138 x 7,68 mm	0,005	

	PL6438B	Cable bleu CE norme	148,70 x 9,30 mm	0,006	
	PL6439	Cable rouge CE norme		0,005	
	PL6440	Cable bleu CE norme		0,004	
	PL6478	CSA cable US norme		0,067	
	PL6458R	Cable CSA rouge US norme		0,006	
	PL6455	Cable CSA rouge double - US norme		0,013	
	PL6458VJ	Cable CSA vert - jaune double US norme		0,006	
	PL6458B	Cable CSA bleu double - US norme		0,006	
	PL6479	CSA cable US norme		0,308	

	PL1060	Attache-cable, noir Polyamid 6.6 Résistance en traction +- 18Kp / 176 N	140 x 3,6 mm	0,001	
	PL9200	Platine électronique pour série N, set complet			
	PL1201	Platine électronique de puissance pour série N	179 x 90 mm	0,309	
	PL1203	Cable de raccordement entre platine de puissance et platine de programmation, série N	113 x 10 mm	0,003	
	PL1202	Platine de programmation pour série N	232 x 47 mm	0,046	
	PL1204A	Platine de programmation pour série C 200 - 250 V			
	PL1204B	Platine de programmation pour série C 110 V			
	PL1002	Goujon fileté à souder DIN EN ISO 13918 M3 x 12 (pour fixation platine)	Ø 3 mm Longueur: 12 mm	0,001	
	PL1211	Ecrou platine pour fixation des platines	Ø 5,40 mm		

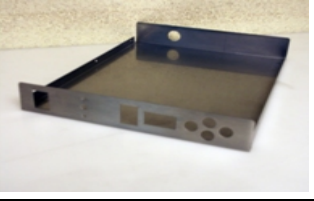
	PL1212	Rondelle pour fixation platine	Ø 6,70 mm		
	PL1206	Sonde de température		0,015	
	PL1207	Sonde de température		0,015	
	PL1208	Sonde de température		0,013	
	PL	C35	Ø 330 mm	1,129	
	PL	C25	Ø 246 mm	0,757	
	PL1041	Isolant thermique pour C35	Ø 325 x 40 mm	0,223	
	PL1301	Boîte en carton	820 x 420 x 200 mm	1,075	
	PL1302	Boîte en carton	420 x 420 x 200 mm	0,715	

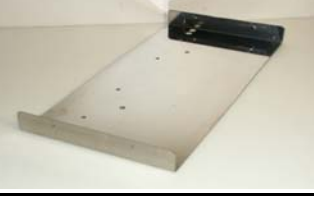
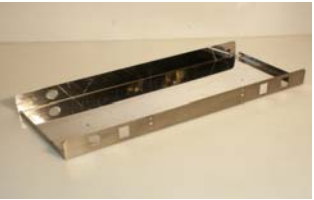
	PL1303	Boîte en carton	570 x 370 x 200 mm	0,773	
	PL1304	Boîte en carton	740 x 570 x 200 mm	1,045	
	PL6311	Couvercle pour gaufrier TS, CS & NS	300 x 300 x 53 mm	0,926	
	PL6310	Fond pour gaufrier TS & C25TS	295 x 240 x 48 mm	0,810	
	PL6301	Couvercle pour gaufrier RTS, RCS & RNS	450 x 300 x 53 mm	1,378	
	PL6322	Fond pour crêpière C35NS	395 x 368 x 50 mm	1,507	
	PL6346	Fond RNS pour gaufrier	390 x 295 x 50 mm	1,198	
	PL6330	Couvercle C35 pour crêpière	400 x 394 x 53 mm	1,509	
	PL6320	Fond C35TS pour crêpière	370 x 396 x 52 mm	1,425	

	PL6300	Fond RTS pour gaufrier	390 x 296 x 50 mm	1,188	
	PL6345	Fond RCS	239 x 298 x 50 mm		
	PL6341	Couvercle RTS, RCS, RNS, pour gaufrier	450 x 229 x 54 mm	1,381	
	PL6331	Couvercle TD, CD, ND	595 x 300 x 54 mm	1,588	
	PL6323	Couvercle C25 TD			
	PL6321	Fond TD / C25TD	595 x 238 x 50 mm	1,552	
	PL6329	Couvercle C35TD	795 x 365 x 51 mm	2,876	
	PL6319	Fond C35TD	795 x 400 x 51 mm	2,714	
	PL6308	Fond NS	390 x 298 x 50 mm		

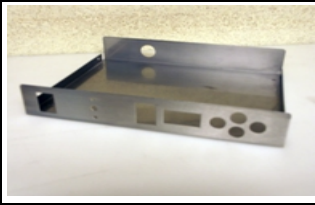

PL6309

Fond CS

390 x 298 x 50 mm

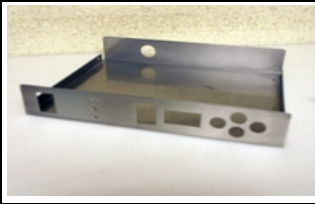
	<p>PL6309</p>	<p>Fond CS</p>	<p>390 x 298 x 50 mm</p>		
-----------------------------------------------------------------------------------	----------------------	----------------	--------------------------	--	--