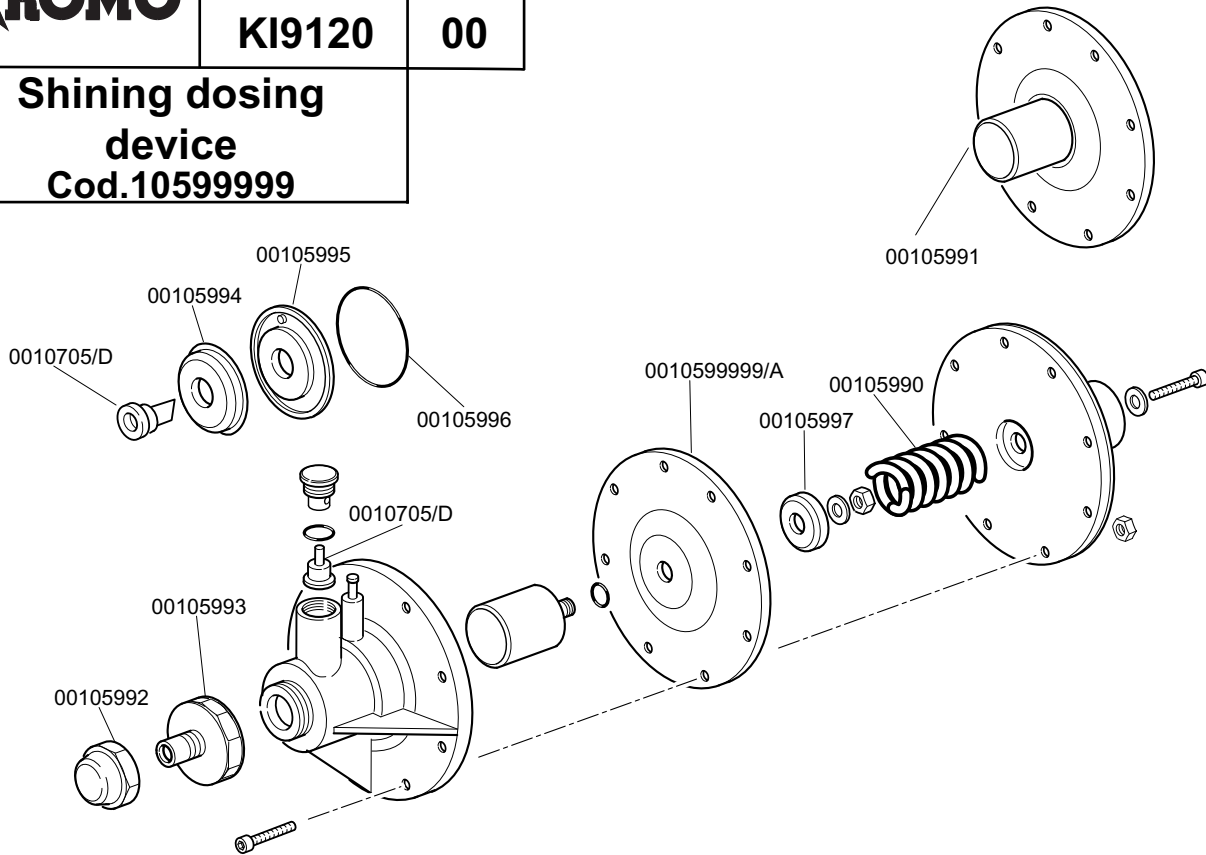
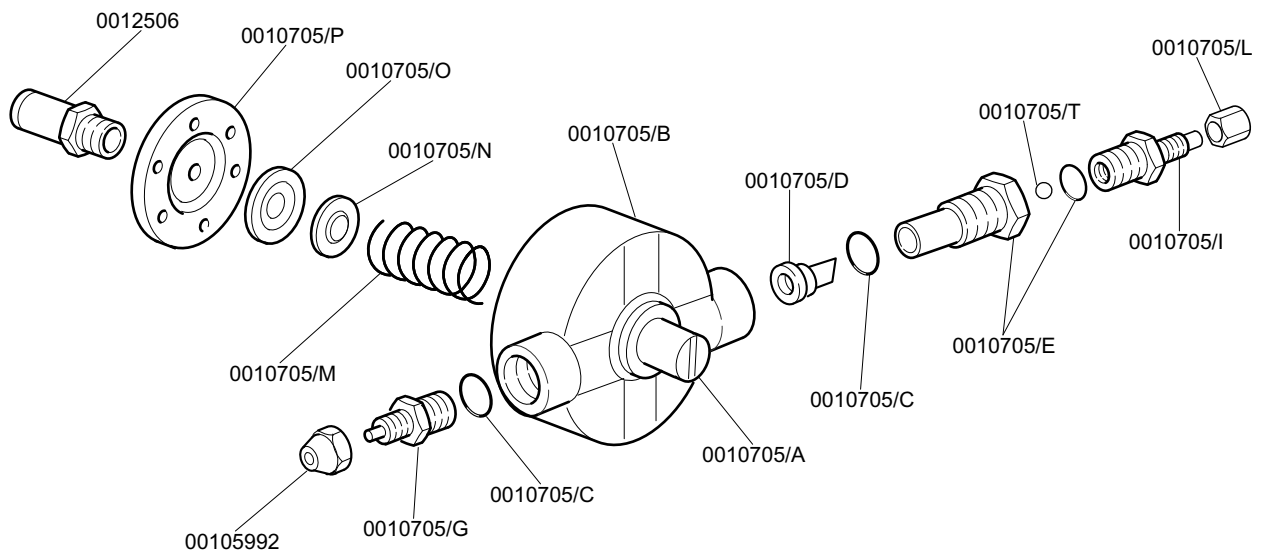
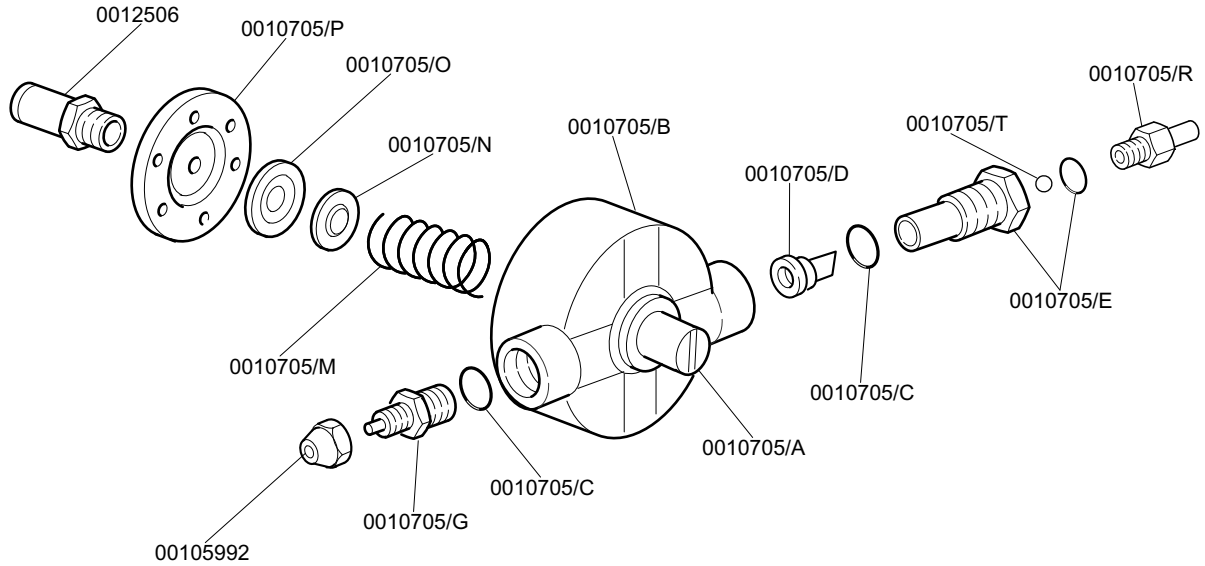
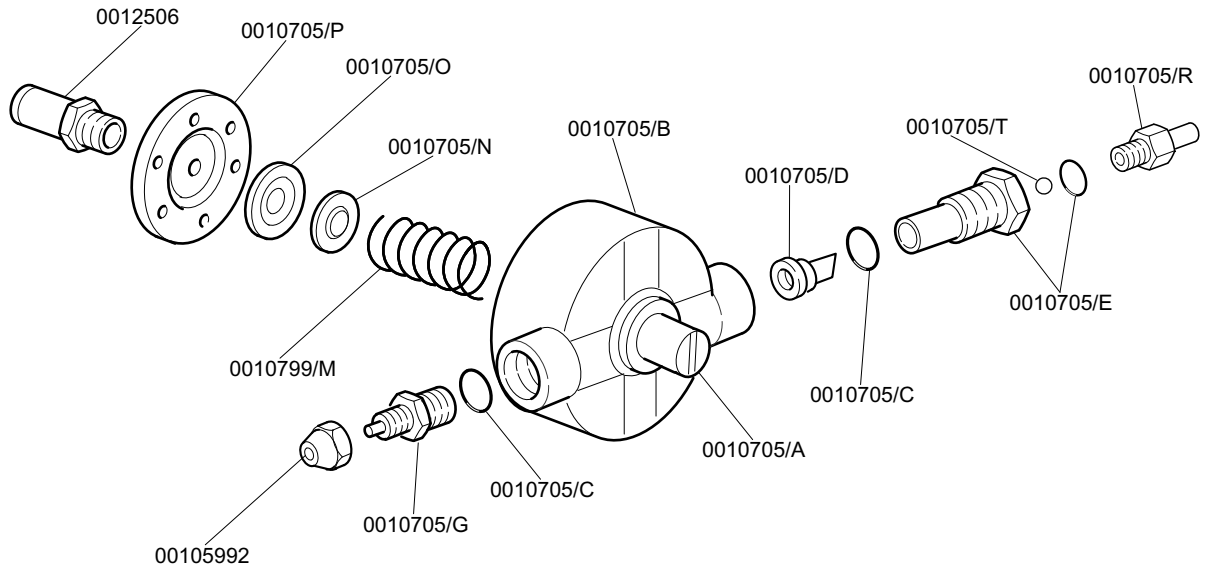
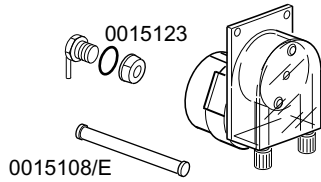
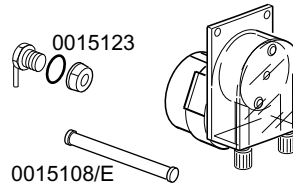
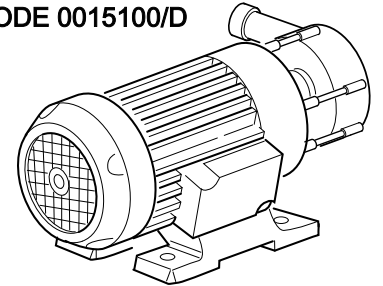
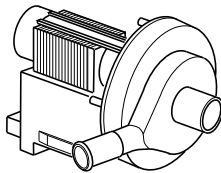
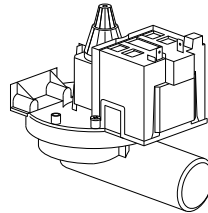
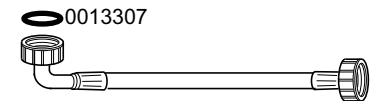
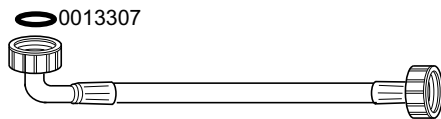
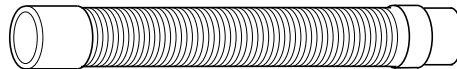
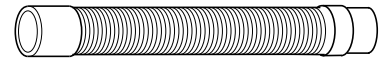
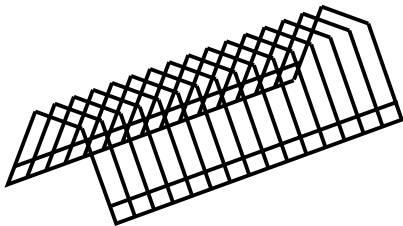
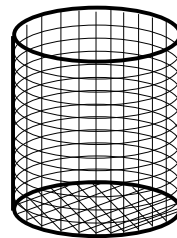
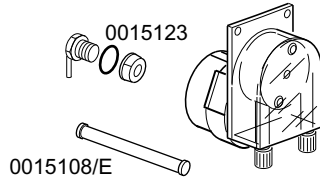
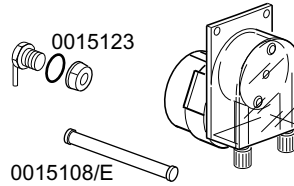
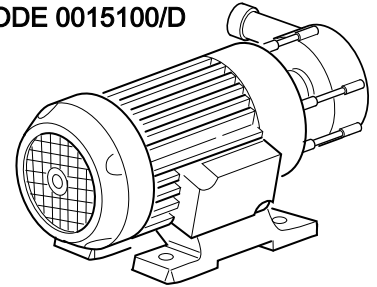
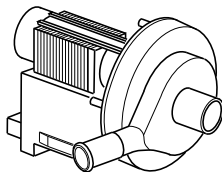
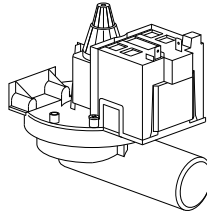
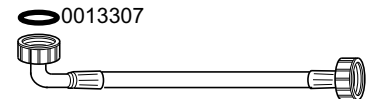
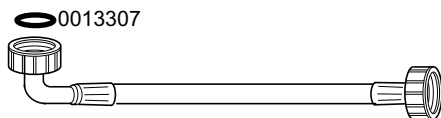
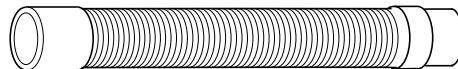
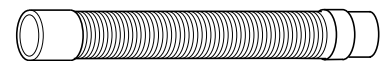
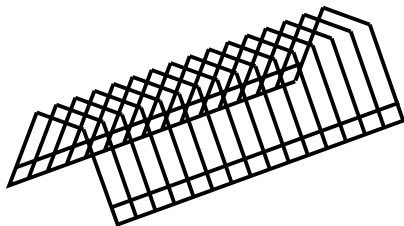
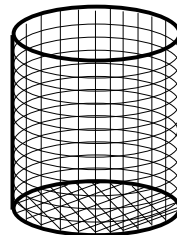
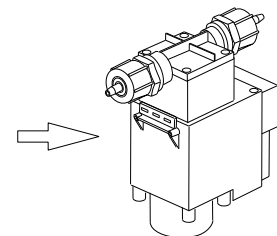

KROMO**TABLE
KI9120****REV
00****Shining dosing
device
Cod.1059999****Shining product dosing
device
Cod.10705**

KROMO**TABLE
KI9121****REV
00****Shining product dosing
device
Cod.10799****Shining product dosing
device
Cod.10799/A**

ACCESSORIES**CODE 0015108/C**
8 liter/h**CODE 0015108**
15 liter/h**CODE 0015100/D****CODE 0015101****CODE 0015101/A****CODE 0010726****CODE 0010900001****CODE 0010200112****CODE 0010727****CODE 0010728****CODE 0015060**

ACCESSORIES**CODE 0015108/C**
8 liter/h**CODE 0015108**
15 liter/h**CODE 0015100/D****CODE 0015101****CODE 0015101/A****CODE 0010726****CODE 0010900001****CODE 0010200112****CODE 0010727****CODE 0010728****CODE 0015060****CODE 0015108/L**

ACCESSORIES

CODE 00C86/A

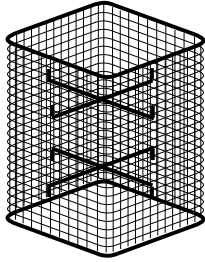

CODE 00C96/A

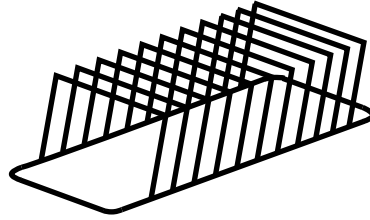

CODE 00C85/A

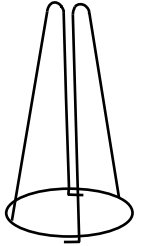

CODE 00C97

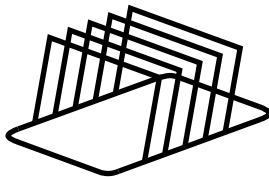

CODE 00C96

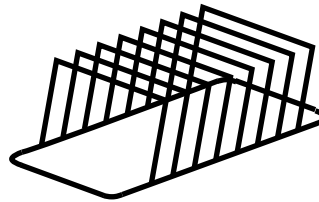

CODE 00C97/A

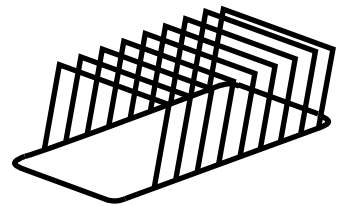

CODE 00C47

