

Shell assembly Mod. GB902-1540-1555 A/W

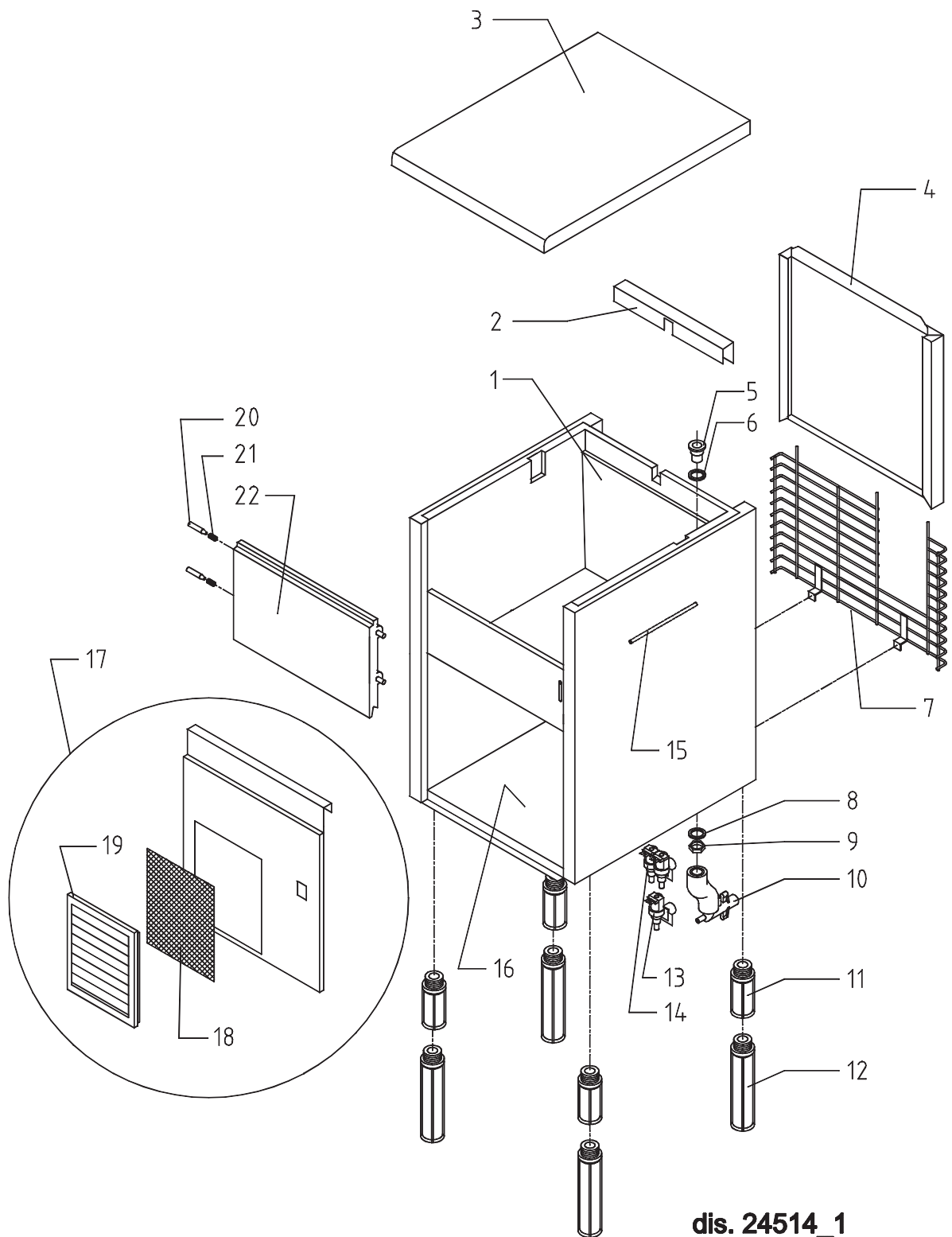

Shell assembly Mod. GB1555 A/W (TAB. 64)

Ref.	Description	Refrigerant	A/W	Tension	Code
1	Foamed cabinet assy				C11098
2	Cover for ice exit passage				22592
3	Top assembly				C22690
4	Back panel assembly				C22290
5	Plastic nipple water outlet				10007
6	Silicone gasket				13006
7	Rear grid				D12020
8	Semirigid polyethylene gasket				13007
9	Bin discharge nut				10096
10	Discharge manifold assy		A		C10235
10	Discharge manifold assy		W		C10240
11	Foot h.100 mm				10040
13	Inlet watervalue 1 way		A	1-2	23115
13	Inlet watervalue 1 way		A	3	23410
14	Inlet watervalue 2 ways		W	1-2	23010
14	Inlet watervalue 2 ways		W	3	23261
15	Bulb thermostat tube				20522
16	Base plate				C21044
17	Front grid panel				C22510
18	Filtering panel				18106
19	Grid+frame				C10205
20	Door pin				10269
21	Door pin spring				20499
22	Door				10275

Note: 15. Code 20017 until number 94814. Code 20522 from number 94815.

Cooling system assembly Mod. GB902-1540-1555 A/W

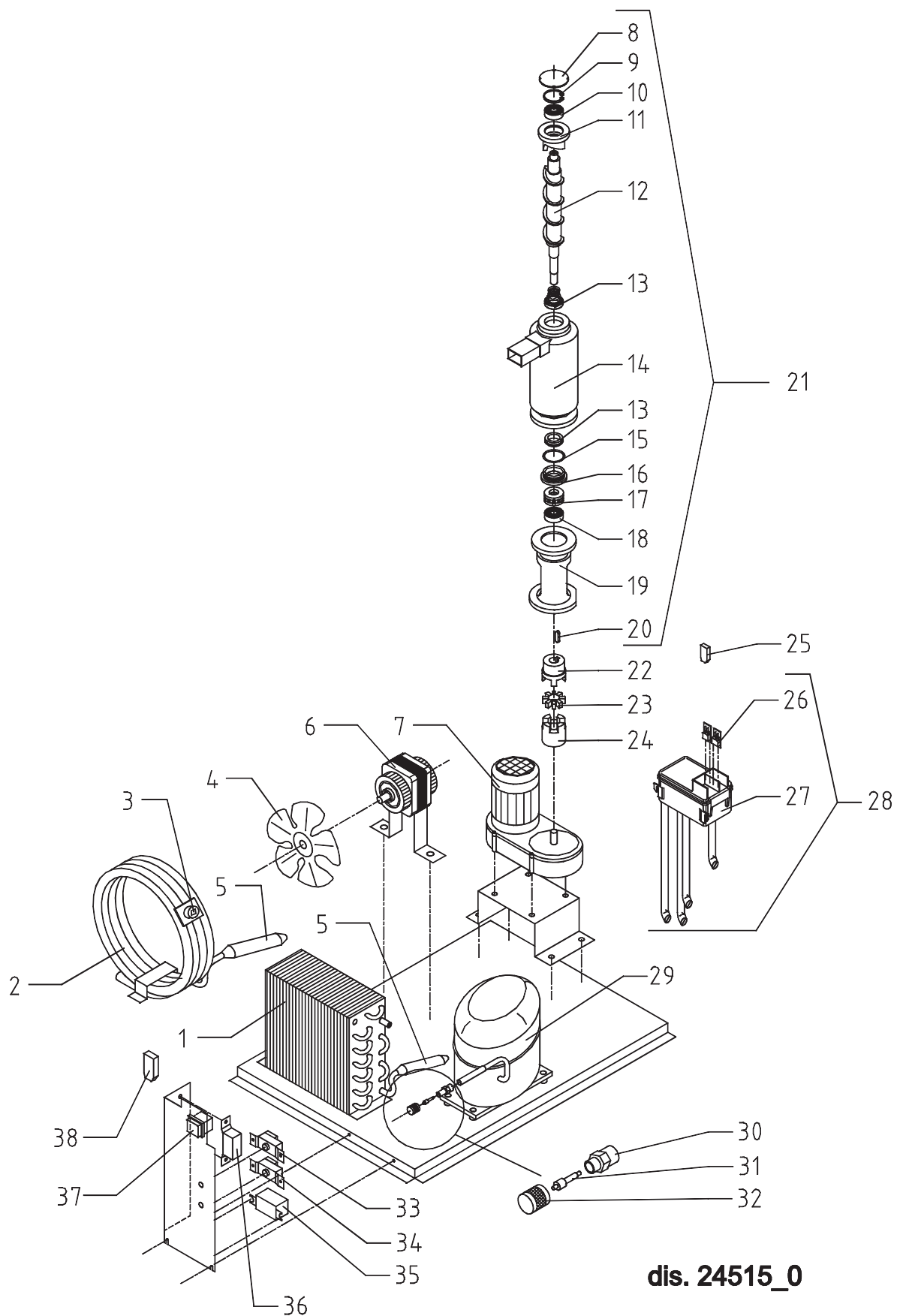

dis. 24515_0

Cooling system assembly Mod. GB1555 A/W (TAB. 67)

Ref.	Description	Refrigerant	A/W	Tension	Code
1	Air condenser		A		20175
2	Water condenser		W		14014
3	Safety thermostat		W		C23114
4	Suction fan 254/31°		A		20031
4	Suction impeller		W		10213
5	Molecular drier				14009
6	Lower fan motor		A	1	23067
6	Lower fan motor		A	2	23580
6	Fan motor		A	3	23393
6	Fan motor		W	1-2	23029
6	Fan motor		W	3	23265
7	Gearmotor			1-2	23532
7	Gearmotor			3	23556
8	Closing disk				22588
9	Seeger ring				20434
10	S/s upper bearing				20433
11	Ice breaker				20440
12	Auger				20439
13	Ceramic seal				20428
14	Foamed evaporator				C11094
15	OR gasket 3162 NBR				20429
16	Reduction ring				20427
17	S/s thrust (roller) bearing				20049
18	Inox bearing				20045
19	Machined joint flange				E20438
20	Key				20431
21	Evaporator Assy				C11095
22	Half coupling				D20430
23	Vibration-damping elastomer				20455
24	Half coupling				D20454
25	Anti radio interference filter			1	23457
26	Microswitch				23055
27	Double switch basin				10145
28	Double switch basin assembly				C10200GB
29	Compressor			1	23575
29	Compressor			2	23578
29	Compressor			3	23579
30	Vacuum- charge valve body				14007
31	Vacuum-charge valve device				14005
32	Vacuum-charge valve plug				14006
33	Bin thermostat				23005
34	Evaporator thermostat				23034
35	Relay			1-2	23190
35	Relay			3	23557
36	Condenser pressure switch				23175
37	Green light switch				23327
38	Anti radio interference filter			1	23459

Note: 4. Code 20052 (A, Tens.1-3) until number 78931. Code 20096 (A, Tens.2) until number 78931. Code 20031 (A) from number 78932.
 29. Code 23505 (Tens.1) until number 74664. Code 23575 (Tens.1) from number 74665.
 28.Code C10200GB was C10200.