



Kühlung Show-Kühlvitrine

Artikel-Nr. 633002 (VGP400 R)

Explosionszeichnung / Ersatzteile

Bitte bei Ersatzteilbestellung immer Artikelnummer und Seriennummer mit angeben!

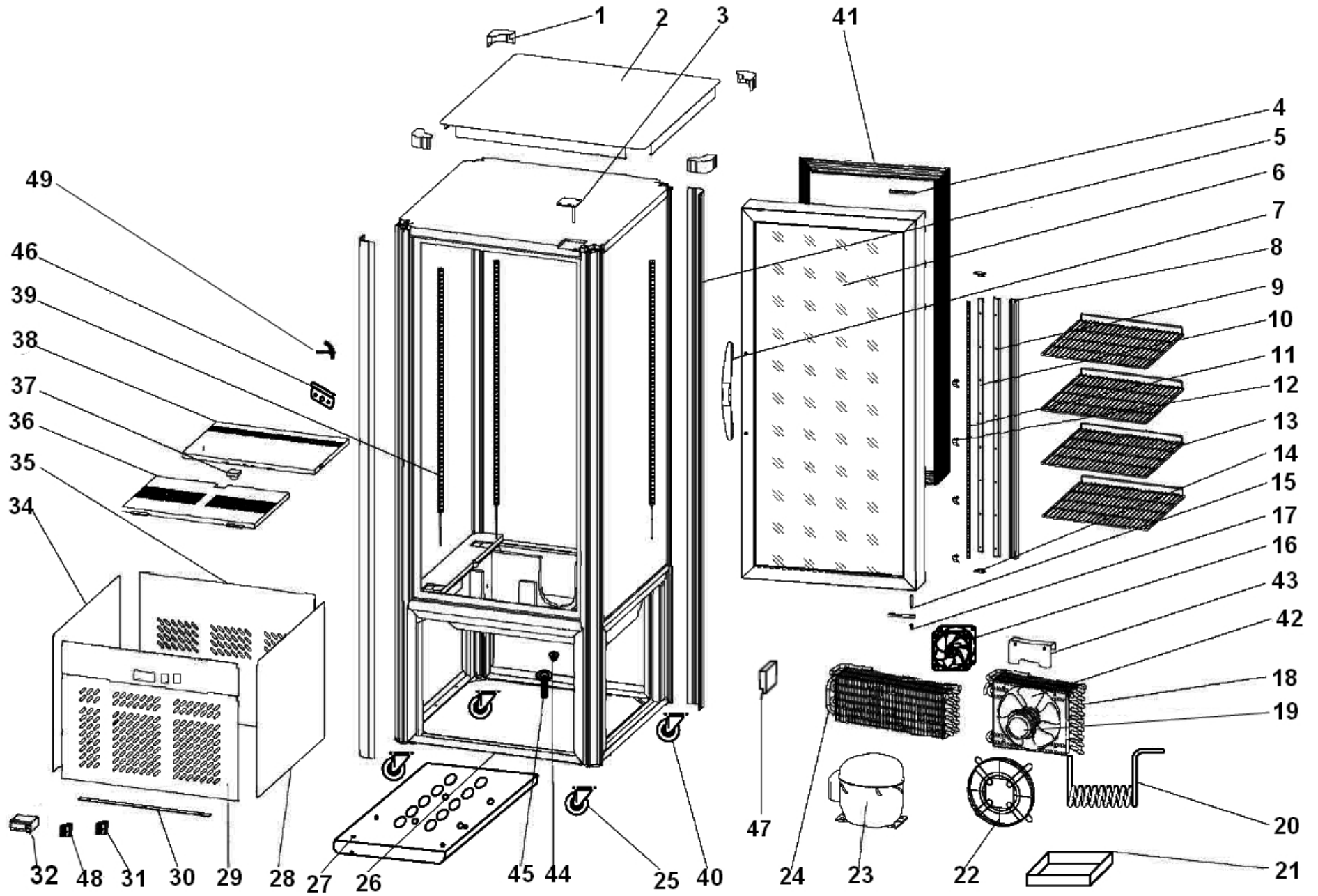

VGP200/400 R

Pos. Ref.	Codice Code	Caratteristiche Features	Descrizione Description	
1	RC0696		Angolare	Angular
2	RC0232		Coperchio	Cover
3	RC0233	Superiore	Cerniera	Hinge
4	RC0182		Staffa	Stirrup
5		VGP200R	Angolare	Angular
5		VGP400R	Angolare	Angular
6	RC0344	VGP200R	Porta	Door
6	RC0254	VGP400R	Porta	Door
7	RC0771		Maniglia	Handle
8			Supporto	Support
9			Supporto	Support
10			Supporto	Support
11			Supporto	Support
12	AG	Kit N°4 Pezzi	Supporto	Support
13	GRCVGP		Griglia	Grill
14			Staffa	Stirrup
15	RC0005	Inferiore	Perno	Pivot
16	RC0654	● Evaporatore	Ventola	Fan
17			Dado	Nut
18	RC0286		Condensatore	Condenser
19	RC0229	Ventola condensatore	Motore	Motor
20			Serpentina	Serpentine
21			Vaschetta	Bowl
22	RC0242		Copertura	Covering
23	RC0678	VGP200R	Compressore	Compressor
23	RC0564	VGP400R	Compressore	Compressor
24	RC0059		Evaporatore	Evaporator
25	RC0756	Con freno H80mm	Ruota	Wheel
26			Carcassa	Housing
27			Pannello	Panel
28	RC0758	Destro	Fianco	Side
29	RC0759		Pannello di controllo	Control panel
30			Staffa	Stirrup
31	SL0621	Generale	Interruttore	Switch
32	SL0531	●	Centralina REK 31 ED	Controls unit REK 31 ED
34	RC0760	Sinistro	Pannello	Panel
35	RC0761	Posteriore	Pannello	Panel
36			Fondo	Bottom
37			Tappo	Tap
38			Fondo	Bottom
39	RC0762	VGP400R Led	Plafoniera	Ceiling
39	RC0892	VGP200R Led	Plafoniera	Ceiling
40	RC0757	H80mm	Ruota	Wheel
41	RC0769	● VGP200R	Guarnizione	Gasket
41	RC0770	● VGP400R	Guarnizione	Gasket
42		Condensatore	Ventola	Fan
43			Supporto	Support
44	RC0275		Piletta	Drain pipe
45			Dado	Nut
46			Staffa	Stirrup
47	RC0891		Trasformatore	Transformer
48	SL0621	● Luce interna	Interruttore	Switch
49	RC0321	●	Sonda NTC	Probe NTC

(*): fuori produzione / out of production

● : ricambio consigliato / spare part suggested