

# E6A77Q

E6A77Q

CATALOGO PARTI DI RICAMBIO  
CATALOGUE PIECES DETACHEES  
ERSATZTEILKATALOG  
SPARE PARTS CATALOGUE





**Catalogo parti di ricambio valido  
dalla matricola 0000001 (31.10.2006) ad oggi (06.01.2017)**

**Catalogue pieces detachees  
valable à partir du numero de Série n. 0000001 (31.10.2006) jusqu'à aujourd'hui  
(06.01.2017)**

**Ersatzteilkatalog  
gültig ab Serien-Nr. 0000001 (31.10.2006) bis heute (06.01.2017)**

**Spare parts catalogue  
valid from serial no. 0000001 (31.10.2006) up today (06.01.2017)**

**Catálogo de peças de reposição  
válido do número de série 0000001 (31.10.2006) até hoje (06.01.2017)**

Le informazioni sono considerate non vincolanti. Le immagini rappresentate sono puramente indicative. Il produttore si riserva il diritto di apportare modifiche in qualsiasi momento senza preavviso.

Les informations données ne sont pas contraignantes. Les images montrées sont à titre indicatif. Le producteur se réserve le droit d'apporter des modifications sans préavis.

Die im vorliegenden Dokument aufgeführten Informationen und Bilder sind unverbindlich. Der Hersteller behält sich das Recht vor, jederzeit ohne vorherige Ankündigung Änderungen vorzunehmen

Info and drawing could be slightly different from reality and they cannot be considered as compelling. Manufacturer can modify info anytime without forewarning.

As Informações e desenhos podem estar um pouco diferente da realidade e são puramente indicativas. O fabricante pode modificar estas informações a qualquer momento sem aviso prévio.

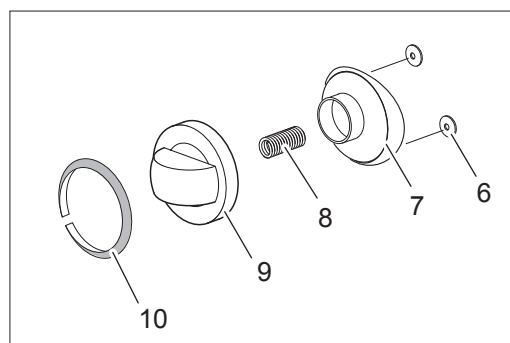
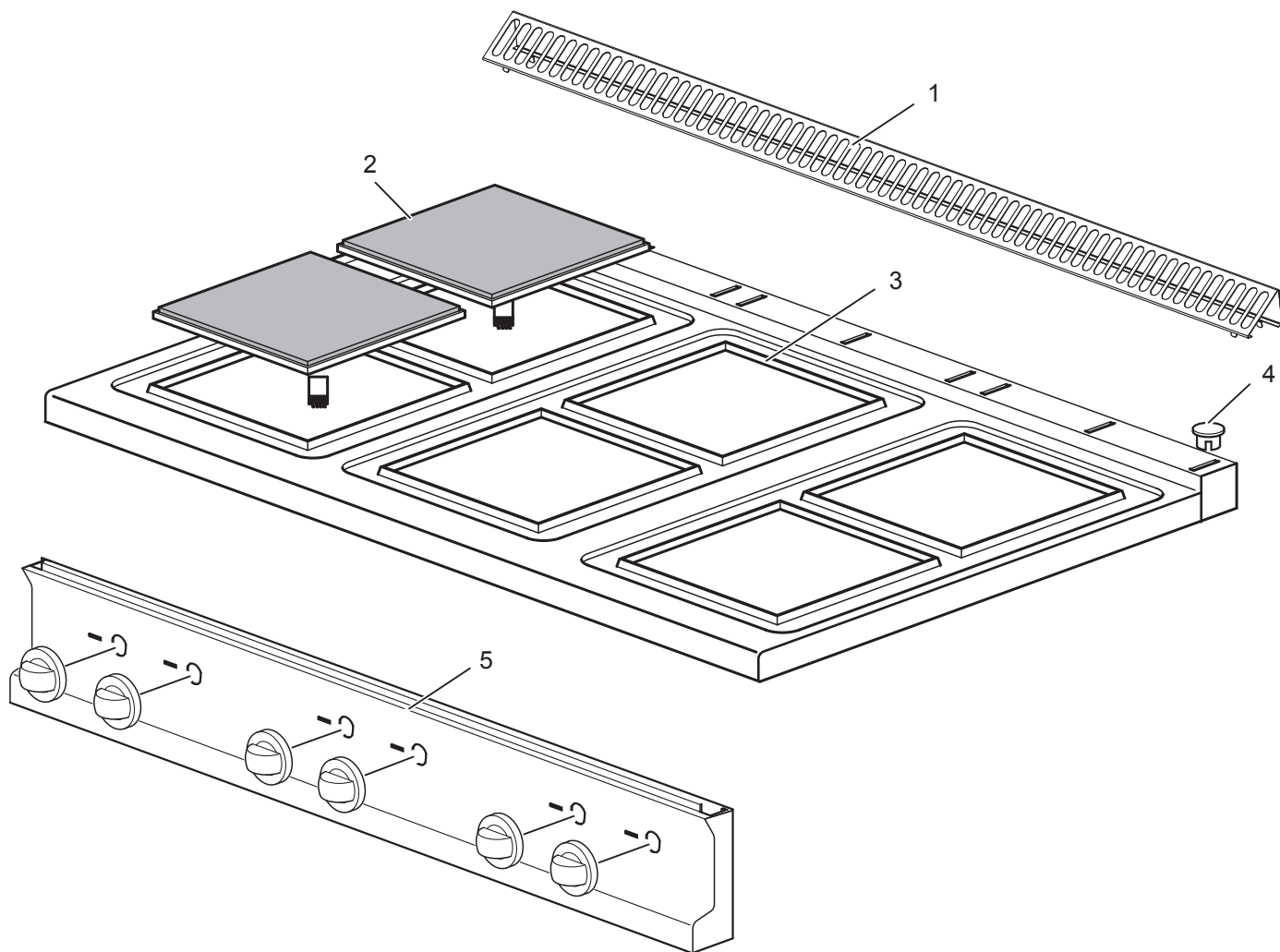

<b>Nr.</b>	<b>Code</b>	<b>Title</b>	<b>Recommended</b>
1.	184978	<i>GRILLE POUR CHEMINÉE</i>	
2.	RTCU700248	<i>PLAQUE ELECTR.E47Q 2,6KW240 1122454233</i>	S
3.	182706	<i>COUVERCLE PLAQUE ELECTRIQUE</i>	N
4.	163603	<i>BOUCHON FIX.PLAQUE DOMINA</i>	N
5.	180316	<i>CONTROL PANEL</i>	N
6.	176318	<i>ELASTIC METAL CLIP -WASHER DIAM 4 MM</i>	S
7.	171439	<i>GAS VALVE KNOB HOUSING G4S11</i>	S
9.	171436	<i>COMMUTATOR KNOB</i>	S
10.	174328	<i>SWITCH RING</i>	S



<b>Nr.</b>	<b>Code</b>	<b>Title</b>	<b>Recommended</b>
1.	167414	<i>BACK SIDE</i>	N
2.	173523	<i>LATERAL SIDE</i>	N
3.	RTCU700277	<i>PIED+BOUCHON S.G4SF7/145</i>	N

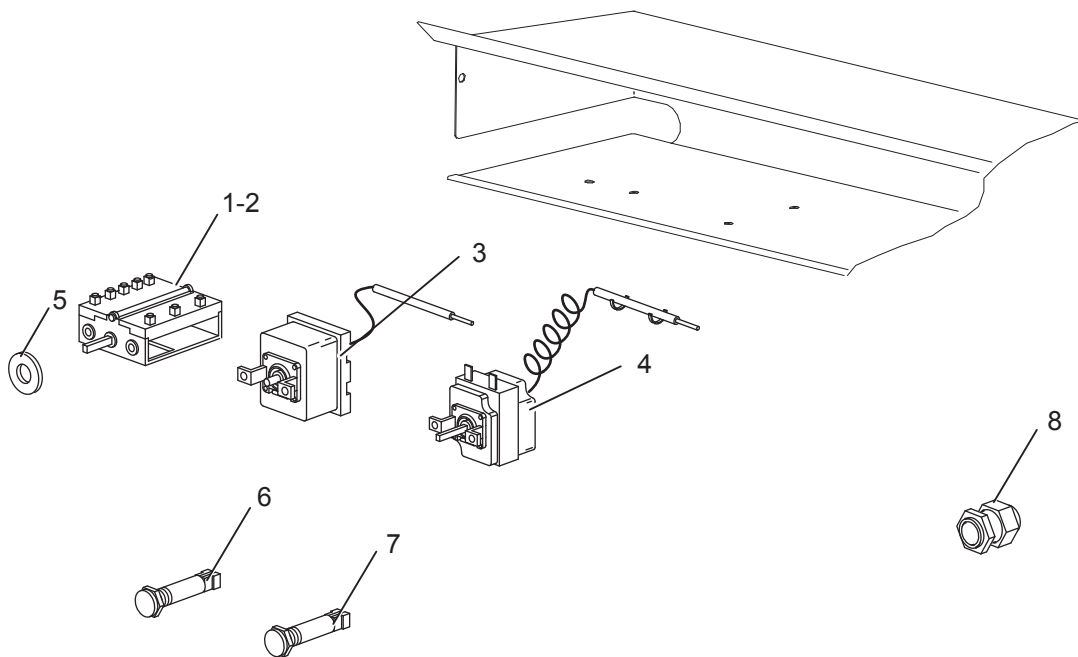

<b>Nr.</b>	<b>Code</b>	<b>Title</b>	<b>Recommended</b>
1.	RTCU700078	COMMUTATEUR P.E.0+6 4927215746	S
5.	RTCU800185	JOINT BARRE COMMUTATEUR	S
6.	166465	LAMPE-TEMOIN VERT SL-CO27500	S
8.	RTBF700021	CABLE PG16 53015040+D53019040	N