

IPERLOTUS 90 TOP

GAS / GAS / GAS / GAZ

PCT-94G PCT-98G PCT-912G PCT-916G

	1	2	3
Vedi Pagina See Page Siehe Seite Voir Page Ver Página	174	175	176

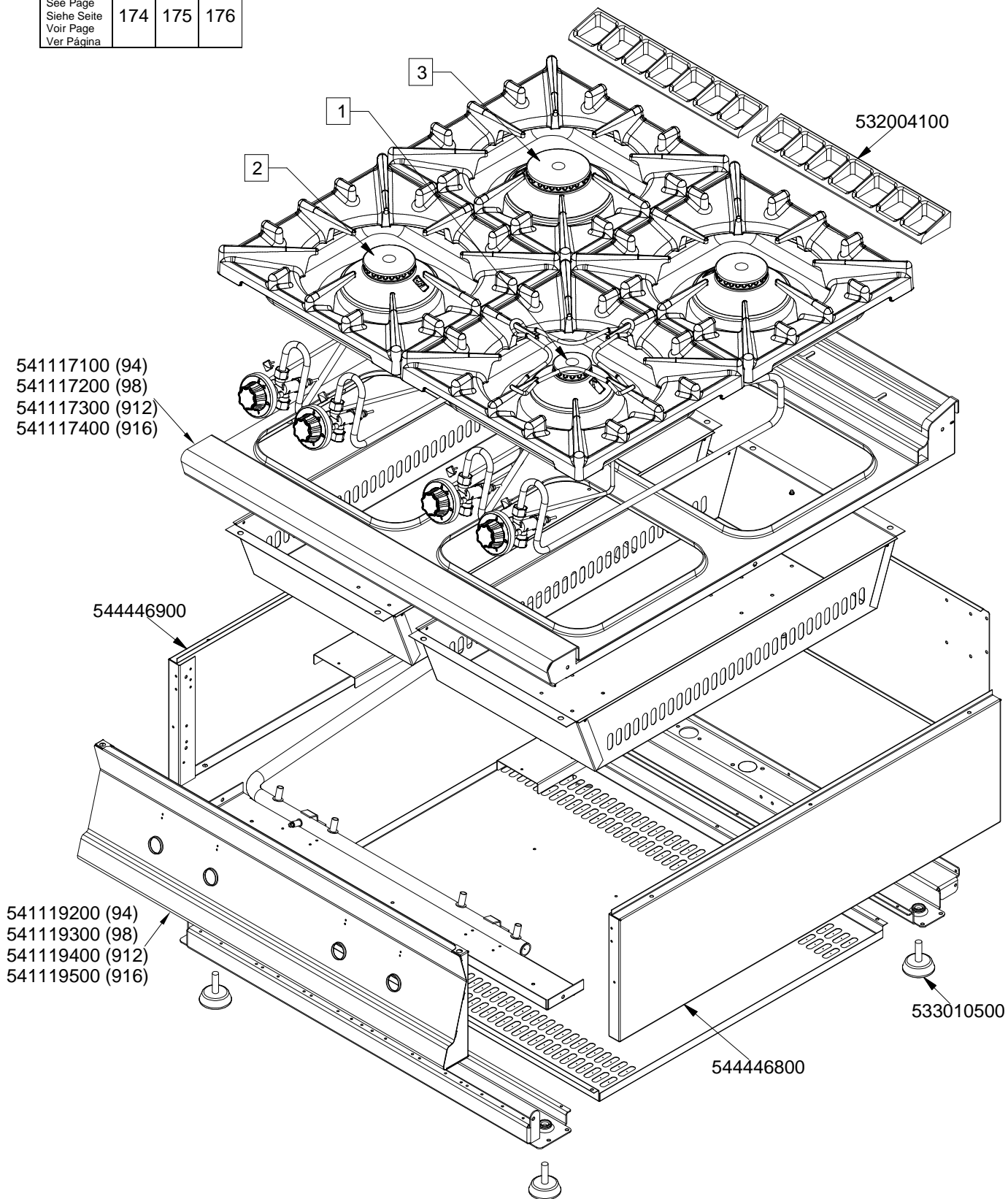

560062400M00P00

IPERLOTUS 90 TOP
COMPONENTI COMUNI / STANDARDS PARTS / UEBLICHE TEILE / COMPOSANTS COMMUNS

PCT-G 4KW

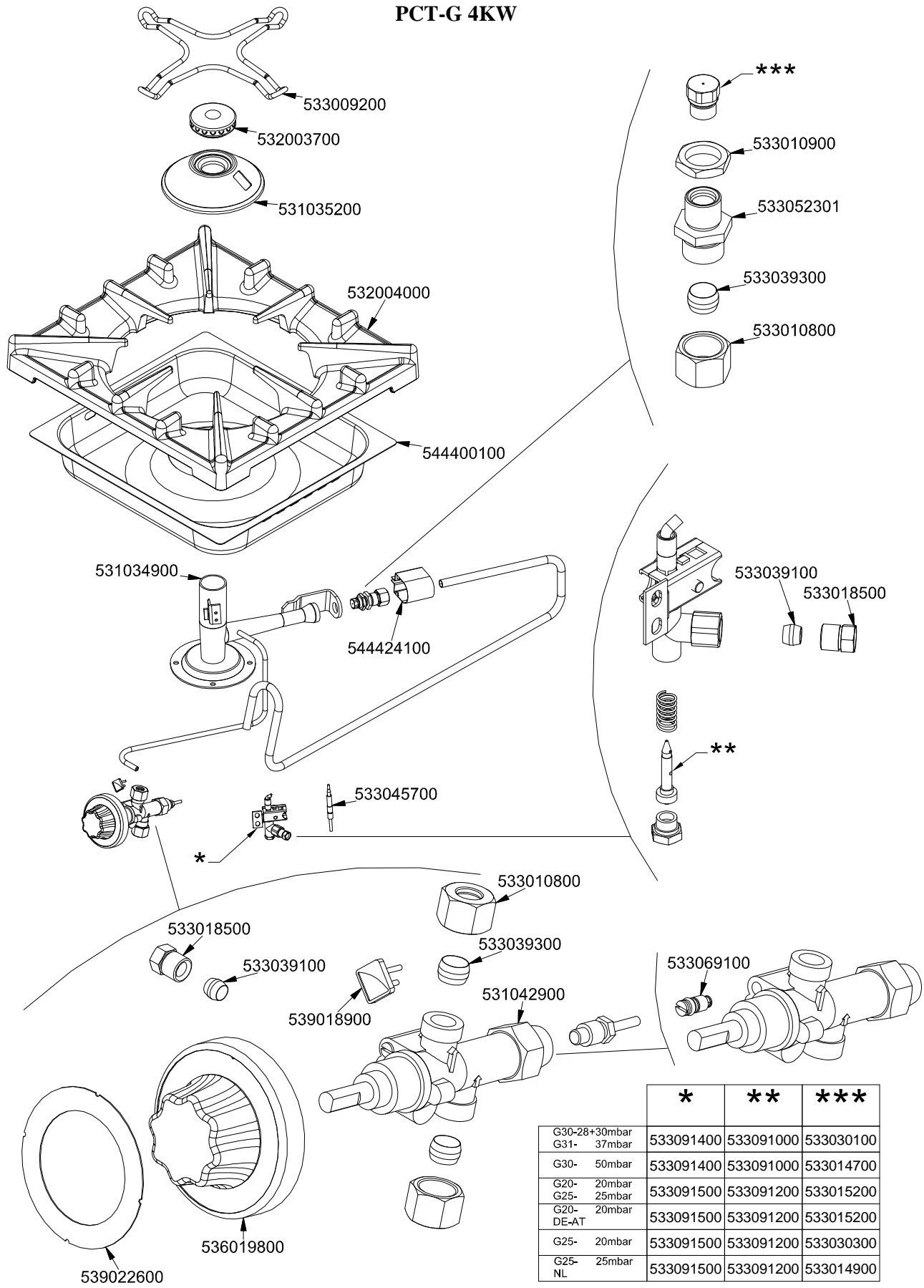

	*	**	***
G30-28+30mbar G31- 37mbar	533091400	533091000	533030100
G30- 50mbar	533091400	533091000	533014700
G20- 20mbar G25- 25mbar	533091500	533091200	533015200
G20- 20mbar DE-AT	533091500	533091200	533015200
G25- 20mbar	533091500	533091200	533030300
G25- 25mbar NL	533091500	533091200	533014900

560023100M00P00

IPERLOTUS 90 TOP
COMPONENTI COMUNI / STANDARDS PARTS / UEBLICHE TEILE / COMPOSANTS COMMUNS

PCT-G 7KW

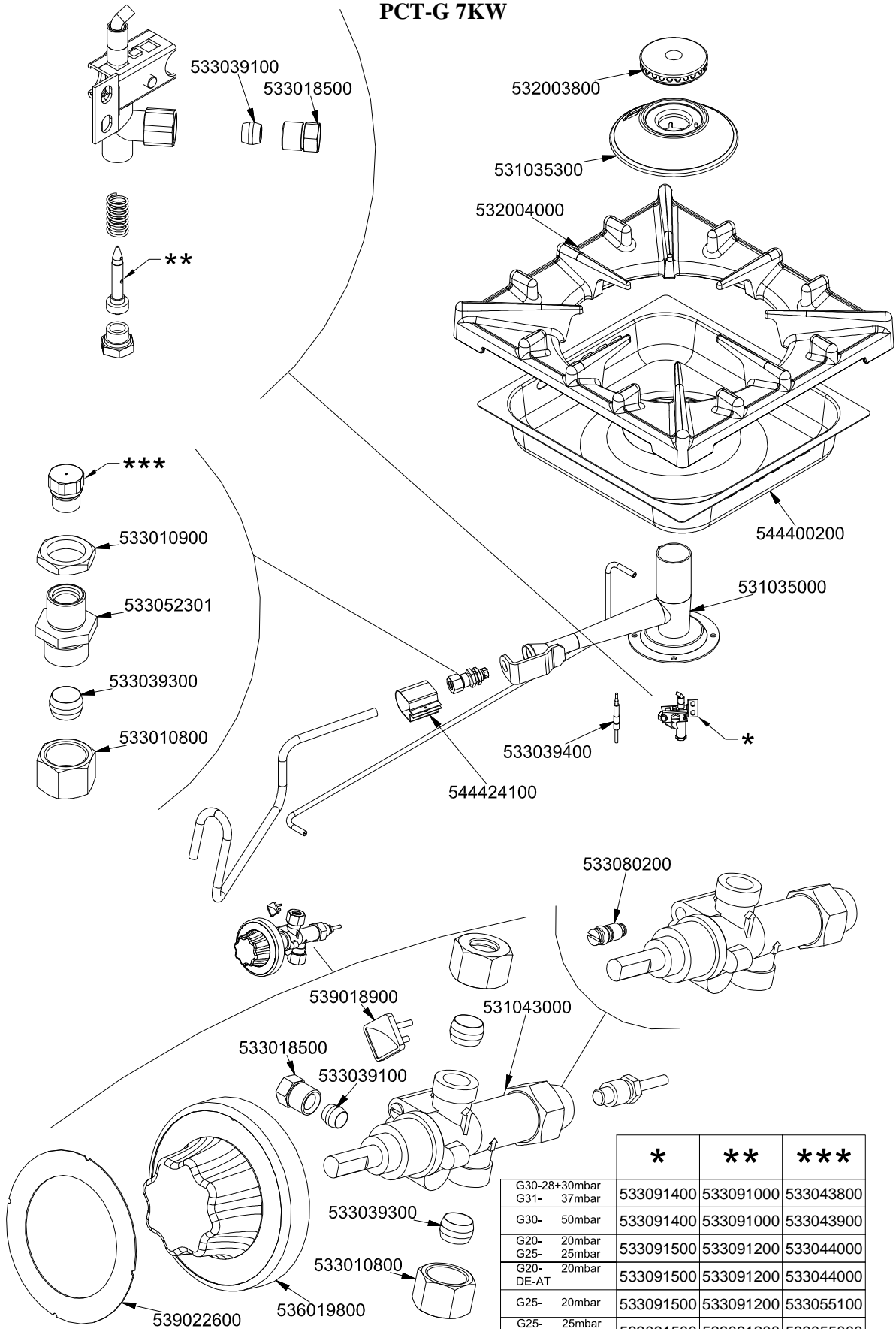

	*	**	***
G30-28+30mbar	533091400	533091000	533043800
G31- 37mbar			
G30- 50mbar	533091400	533091000	533043900
G20- 20mbar	533091500	533091200	533044000
G25- 25mbar			
G20- 20mbar	533091500	533091200	533044000
DE-AT			
G25- 20mbar	533091500	533091200	533055100
G25- 25mbar	533091500	533091200	533055000
NL			

560023200M00P00

IPERLOTUS 90 TOP
COMPONENTI COMUNI / STANDARDS PARTS / UEBLICHE TEILE / COMPOSANTS COMMUNS

PCT-G 10KW

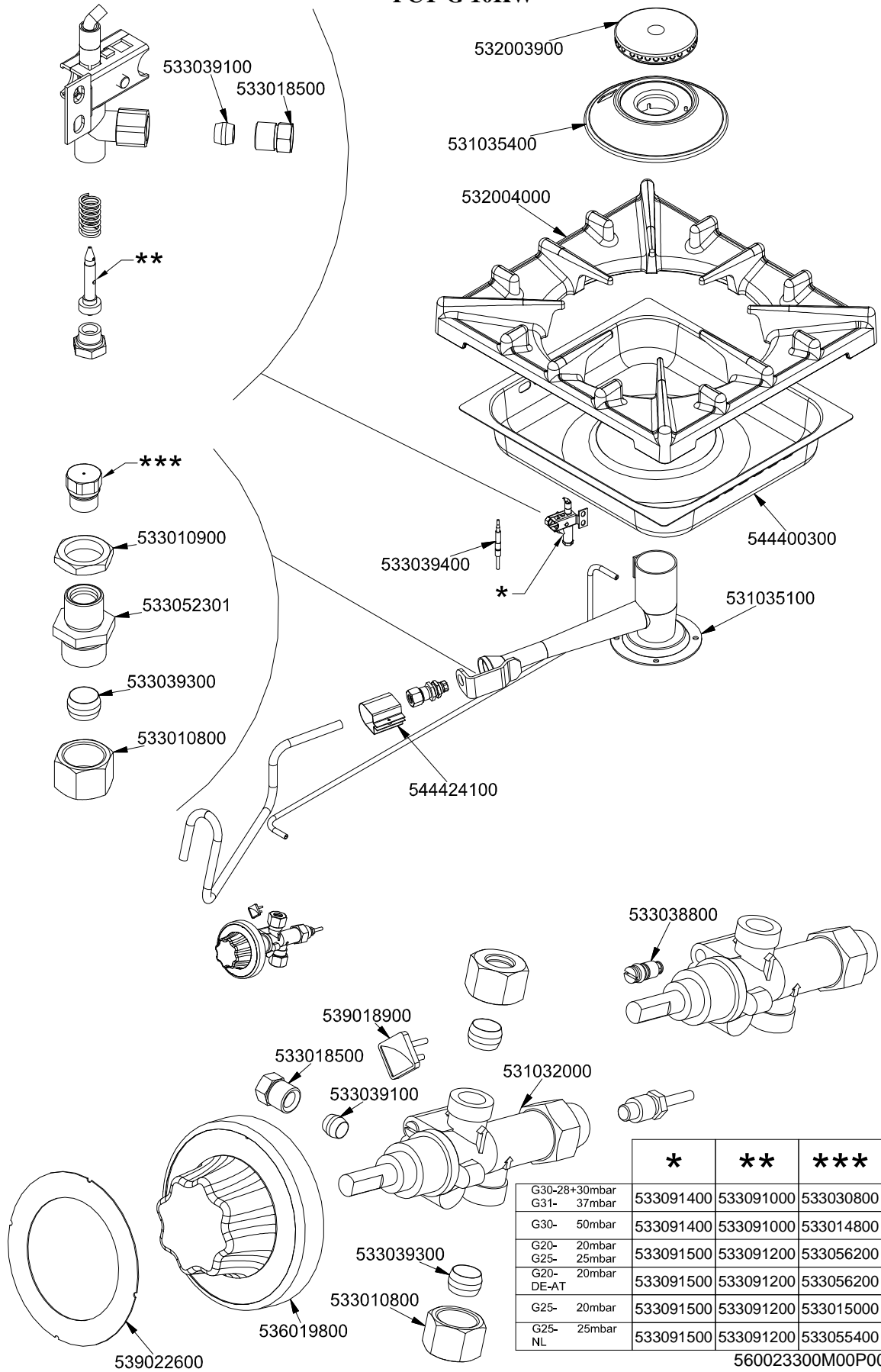

	*	**	***
G30-28+30mbar	533091400	533091000	533030800
G31- 37mbar			
G30- 50mbar	533091400	533091000	533014800
G20- 20mbar	533091500	533091200	533056200
G25- 25mbar	533091500	533091200	533056200
G20- 20mbar	533091500	533091200	533056200
G25- 20mbar	533091500	533091200	533015000
G25- 25mbar	533091500	533091200	533055400

560023300M00P00

Page	Pos	Code	Description
001		541119300	FRONT PANEL PC-98G
001		541117200	UPPER PLATE PC-98G
001		532004100	FLUE GRID L=370 70LINE (RAF)
001		544446900	
001		544446800	
001		533010500	LEG M10*25 D.40
002		533030100	NOZZLE §95 CH12*14 G-FP
002		533014700	NOZZLE §85 CH12*14 F-FQ5
002		533015200	NOZZLE §145 CH12*14 F-FP/CP6
002		533030300	NOZZLE §160 CH12*14 M-FPG
002		533014900	NOZZLE §150 CH12*14 F-FQ5 L-FQ6
002		533091000	NOZZLE 0.100 §20
002		533091200	PILOT NOZZLE 0100 Ø35 PIL.PC
002		533091400	P.NOZZLE S100 UG.§20 PC90 LPG-FLUS
002		533091500	PILOT NOZZLE S.100 §30 PC90 NAT.GAS
002		533009200	REDUCTION FOR 65 AND 70 LINE
002		532003700	BURNER COVER RING §060
002		531035200	SMALL BURNER BODY 90 LINE
002		532004000	1 FLAME GRILL 396X366 (90)
002		533010900	NUT M14*1 H.4
002		533052301	JOINT FOR NOZZLE HOLDER
002		533039300	BICONE §10
002		533010800	TUBE NUT D.10 M16*1,5
002		544400100	BURNER DRIP PAN 2/3
002		531034900	SMALL BURNER VENTURI 90 LINE
002		544424100	
002		533039100	BICONE §6
002		533018500	FITTING FOR BICONE D.6 M10*1
002		533045700	THERMOCOUPLE M9*1 500
002		533069100	BY PASS COCK §60 20S
002		531042900	B.PASS §60 SAFETY COCK PC/CF 90
002		536019800	BLACK KNOB §70 PIN §8*6,5
002		539022600	GRADUATED STICKER FOR KNOB
003		533043800	NOZZLE §130 CH12*14 G-CW4
003		533043900	NOZZLE §115 CH12*14 F-CW4
003		533044000	NOZZLE §195 CH12*14 M-CW4
003		533055100	NOZZLE §215 CH12*14 L-CW4
003		533055000	NOZZLE §205 CH12*14 G25 CW4
003		533091000	NOZZLE 0.100 §20
003		533091200	PILOT NOZZLE 0100 Ø35 PIL.PC
003		533091400	P.NOZZLE S100 UG.§20 PC90 LPG-FLUS
003		533091500	PILOT NOZZLE S.100 §30 PC90 NAT.GAS
003		533039100	BICONE §6
003		533018500	FITTING FOR BICONE D.6 M10*1
003		532003800	BURNER COVER RING §082
003		531035300	MEDIUM BURNER BODY 90 LINE
003		532004000	1 FLAME GRILL 396X366 (90)
003		544400200	BURNER DRIP PAN 2/3
003		531035000	MEDIUM BURNER VENTURI 90 LINE
003		533010900	NUT M14*1 H.4
003		533052301	JOINT FOR NOZZLE HOLDER

Page	Pos	Code	Description
003		533039300	BICONE §10
003		533010800	TUBE NUT D.10 M16*1,5
003		533039400	THERMOCOUPLE M9*1*850
003		544424100	
003		533080200	BY PASS COCK §65 20S-21S
003		539018900	INDEX FOR KNOB
003		531043000	GAS COCK 21S P.V. BY-PASS §065
003		536019800	BLACK KNOB §70 PIN §8*6,5
003		539022600	GRADUATED STICKER FOR KNOB
004		533030800	NOZZLE §155 CH12X14 M-CW
004		533014800	NOZZLE §135 CH12*14,0
004		533056200	NOZZLE §230 CH12*14
004		533015000	NOZZLE D.I 260 G110 (TOWN GAS)
004		533055400	NOZZLE §245 CH12*14
004		533091000	NOZZLE 0.100 §20
004		533091200	PILOT NOZZLE 0100 Ø35 PIL.PC
004		533091400	P.NOZZLE S100 UG.§20 PC90 LPG-FLUS
004		533091500	PILOT NOZZLE S.100 §30 PC90 NAT.GAS
004		532003900	BURNER COVER RING §100
004		531035400	BIG BURNER BODY 90 LINE
004		532004000	1 FLAME GRILL 396X366 (90)
004		533039100	BICONE §6
004		533018500	FITTING FOR BICONE D.6 M10*1
004		533039400	THERMOCOUPLE M9*1*850
004		544400300	BURNER DRIP PAN 2/3
004		531035100	BIG BURNER VENTURI 90 LINE
004		533010900	NUT M14*1 H.4
004		533052301	JOINT FOR NOZZLE HOLDER
004		533039300	BICONE §10
004		533010800	TUBE NUT D.10 M16*1,5
004		544424100	
004		533038800	75 BY-PASS FOR 21S TAP
004		539018900	INDEX FOR KNOB
004		531032000	GAS COCK P.V.BY-PASS Ø075
004		536019800	BLACK KNOB §70 PIN §8*6,5