

**FT...74ET FT...78ET FT...712ET**

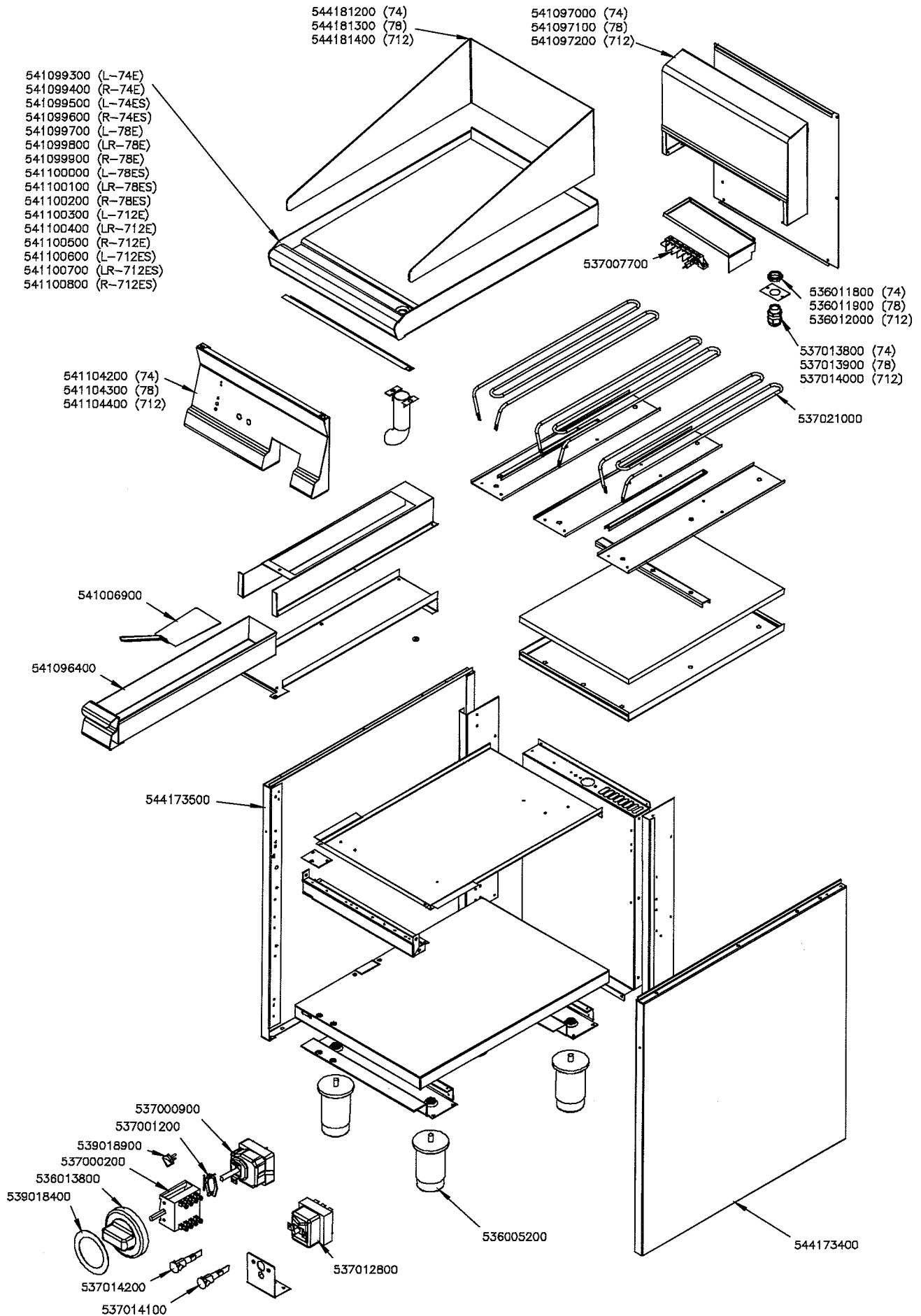

Page	Pos	Code	Description
001		541104300	CONTROL PANEL FT-78E
001		544181300	SPLASH GUARD FT-78
001		541097100	NEUTRAL SPACER 78
001		536011900	HEXAGONAL LOCK NUT PG-16
001		537013900	CABLE SECURING CLAMP PG-16
001		537007700	TERMINAL BLOCK THREEPHASE 40A
001		537021000	HEATING ELEMENT 1500W 230V FT S.70
001		541006900	SPATTLE FT
001		541096400	DRIP TRAY FT S.70
001		544173500	LEFT SIDE PANEL S.70
001		537000900	THERMOSTAT 50-320°C THREEPHASE
001		537001200	FIXING BRACKET FOR THERMOSTAT/COMM.
001		539018900	INDEX FOR KNOB
001		537000200	COMMUTATOR 1 POS. 3PHASE S.49 16A
001		536013800	KNOB D.70 BLACK 6*5 WITH SPRING
001		539018400	ADHESIVE GRADUATED DISC FOR KNOB
001		537014200	GREEN WARNING LIGHT 250V
001		537014100	WHITE WARNING LIGHT 250V
001		537012800	SAFETY THERMOSTAT 420°C THREEPHASE
001		536005200	INOX LEG 2" 120-180 M10
001		544173400	RIGHT SIDE PANEL S.70
001		541099700	UPPER PLATE FTL-78E