

DOMINATOR PLUS

ITEM	DESCRIPTION	SPARES No
1	DOOR ASSEMBLY	731330000
1.1	DOOR HANDLE	736010020
1.2	DOOR HINGE BUSH (x2)	536060036
2	DOOR HINGE - TOP	535200006
3	DOOR HINGE - BOTTOM	535200007
4	DRAIN TUBE ASSEMBLY	535710015
5	ADJUSTABLE FOOT	535290028
6	CASTOR - BRAKED (x2) - NOT SHOWN	536430110
7	CASTOR - FIXED (x2) - NOT SHOWN	536470013
8	DRAIN PROD / LIFTING TOOL	731350012
9	OUTER SIDE PANEL - RH	535670004
10	OUTER SIDE PANEL - LH	535670005
11	CONTROL PANEL	731330001
12	HOB/PAN ASSEMBLY C/W DRAIN VALVE	731330002
12.1	DRAIN VALVE ASSEMBLY	535670008
13	ELEMENT GUARD	731330003
14	BASKET (x1)	531302010
15	DUST COVER	731330004
16	BASKET HANGER	731330005

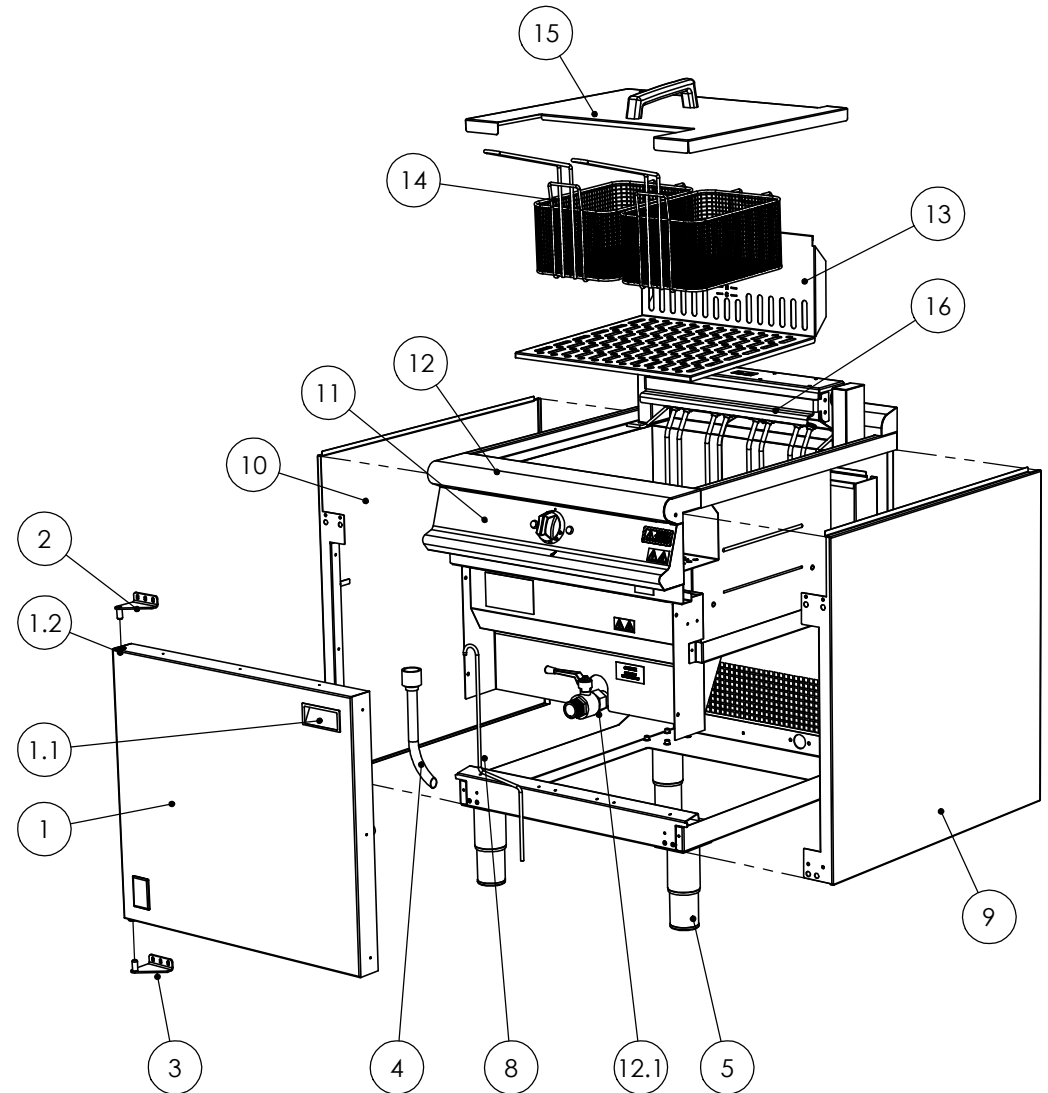

Issue	Alteration	Date	Product	Document Reference
A	Initial Issue	09/08/11	E3860	AD49202A

DOMINATOR PLUS

ITEM	DESCRIPTION	SPARES No
1	MAINS CABLE GLAND C/W NUT	731350026
2	MAINS TERMINAL BLOCK	731000006
3	CONTACTOR	734510010
4	OPERATING THERMOSTAT	731320106
5	CONTROL KNOB	731320107
6	RED NEON	735010370
7	AMBER NEON	735010380
8	ELEMENT C/W GASKETS	731320108
8.1	ELEMENT SET C/W GASKETS (4 OFF)	731330006
9	ELEMENT CLAMP ASSEMBLY	731330007
10	TILT SWITCH	735750014
11	SAFETY STAT C/W FITTINGS	731320111
12	WIRING LOOM (NOT SHOWN)	731330008

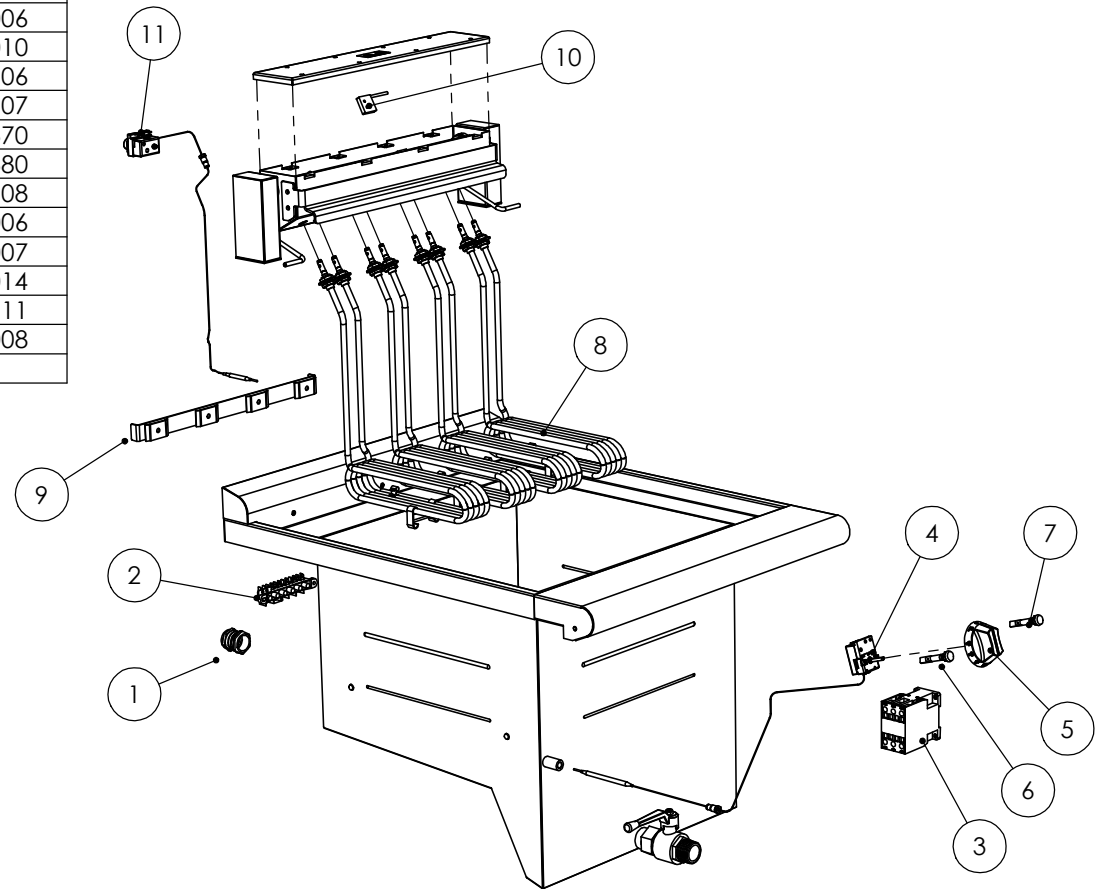

Issue	Alteration	Date	Product	Document Reference
A	Initial Issue	09/08/11	E3860	AD49203