



Tiefkühlschrank 700 I, GN 2/1, für Zentralkühlung mit Ventil R404

Artikel-Nr.
90622042 (7E070RBC5P002 / ENERGY 700BT R R404)

Explosionszeichnung / Ersatzteile

Bitte bei Ersatzteilbestellung immer Artikelnummer und
Seriennummer mit angeben!

7E070RBC5P002-CABINET 700 BT REM. ENERGY

Content filters: validity 11/09/2018

11/09/2018

7E070RBC5P002 - 7E070RBC5P002-CABINET 700 BT REM. ENERGY.....	3
7E070RBC5P002-OPT - EXPLODED VIEW OF OPTIONAL PARTS & FEATURES.....	5
SC720 - ELECTRICAL WIRING.....	7
Components index.....	8

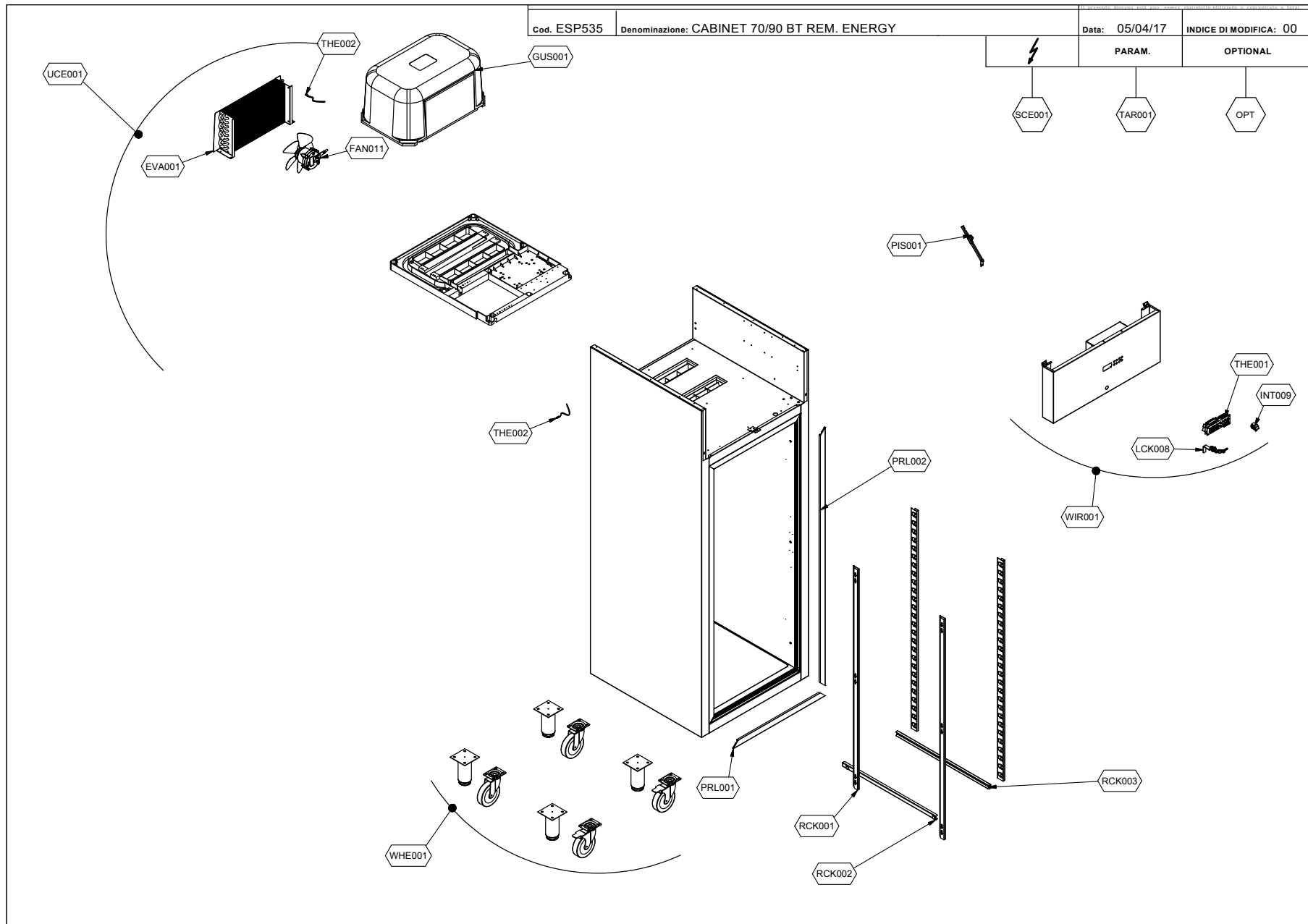





















7E070RBC5P002-CABINET 700 BT REM. ENERGY - Content filters: validity 11/09/2018

7E070RBC5P002 - 7E070RBC5P002-CABINET 700 BT REM. ENERGY









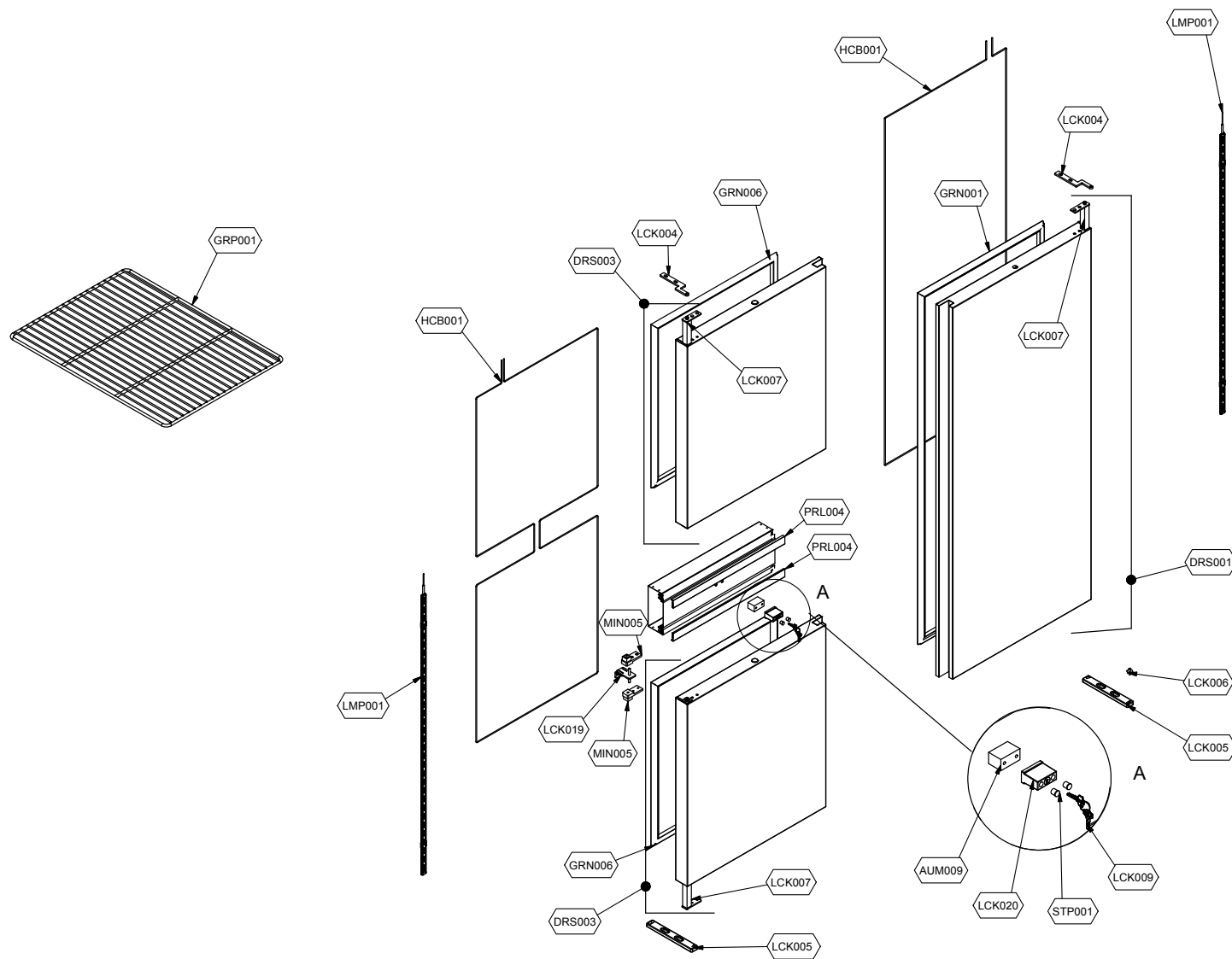

Validity: from 23/01/2018

11/09/2018

Page 3 / 8

Purch.	Pos.	Code	Q.ty	Description	Spare parts after year	Notes
	EVA001	74837324	1	EVAPORATOR	5	
	FAN011	73688646	1	KIT FAN	2	
	GUS001	74701641	1	WARM CABLE		
	HCB002	74837340	1	WARM CABLE		
	INT009	78010438	1	MICROSWITCH	2	
	LCK008	73688080	1	LOCK		
	OPT	7E070RBC5P002- OPT	1	EXPLODED VIEW OF OPTIONAL PARTS & FEATURES		
	PIS001	74700180	1	PISTON	3	
	PRL001	72609622	1	MOBILE HORIZONTAL COVER		
	PRL002	72609626	1	MOBILE VERTICAL COVER		
	RCK001	74779100	1	UNIVERSAL RACK		
	RCK003	74703270	1	RIGHT RUNNER		
	RST001	74837334	1	HEATING ELEMENT	2	
	RST002	74837338	1	HEATING ELEMENT	2	
	RST003	74837398	1	HEATING ELEMENT	2	
	SCE001	SC720	1	ELECTRICAL WIRING	1	
	TAR001	RIF.TAR.P02	1	CONTROLLER PRESETTING SERVICE	1	
	THE001	74700889	1	UNSETTED ELECTRONIC CONTROLLER	1	
	THE002	74700917	1	PROBE	1	
	UCE001	74861166	1	FULL CONDENSING UNIT		
	WHE001	74702570	1	CASTOR/FEET		
	WIR001	73691880	1	ELECTRICAL PANEL		



Purch.	Pos.	Code	Q.ty	Description	Spare parts after year	Notes
	DRS001	73692250	1	DOOR		
	FAN009	73688646	1	KIT FAN	2	
	GRN001	74703384	1	GASKET	2	
	HCB001	73632294	1	WARM CABLE		
	HCB001	74837340	1	WARM CABLE		
	LCK005	74708202	1	LOWER DOOR SUPPORT		
	LCK006	74708126	1	BOTTOM HINGE		
	LMP001	74755590	1	LED LIGHTING		
	THE003	74701161	1	LED POWER PACK	1	
	WHE001	74702570	1	CASTOR/FEET		

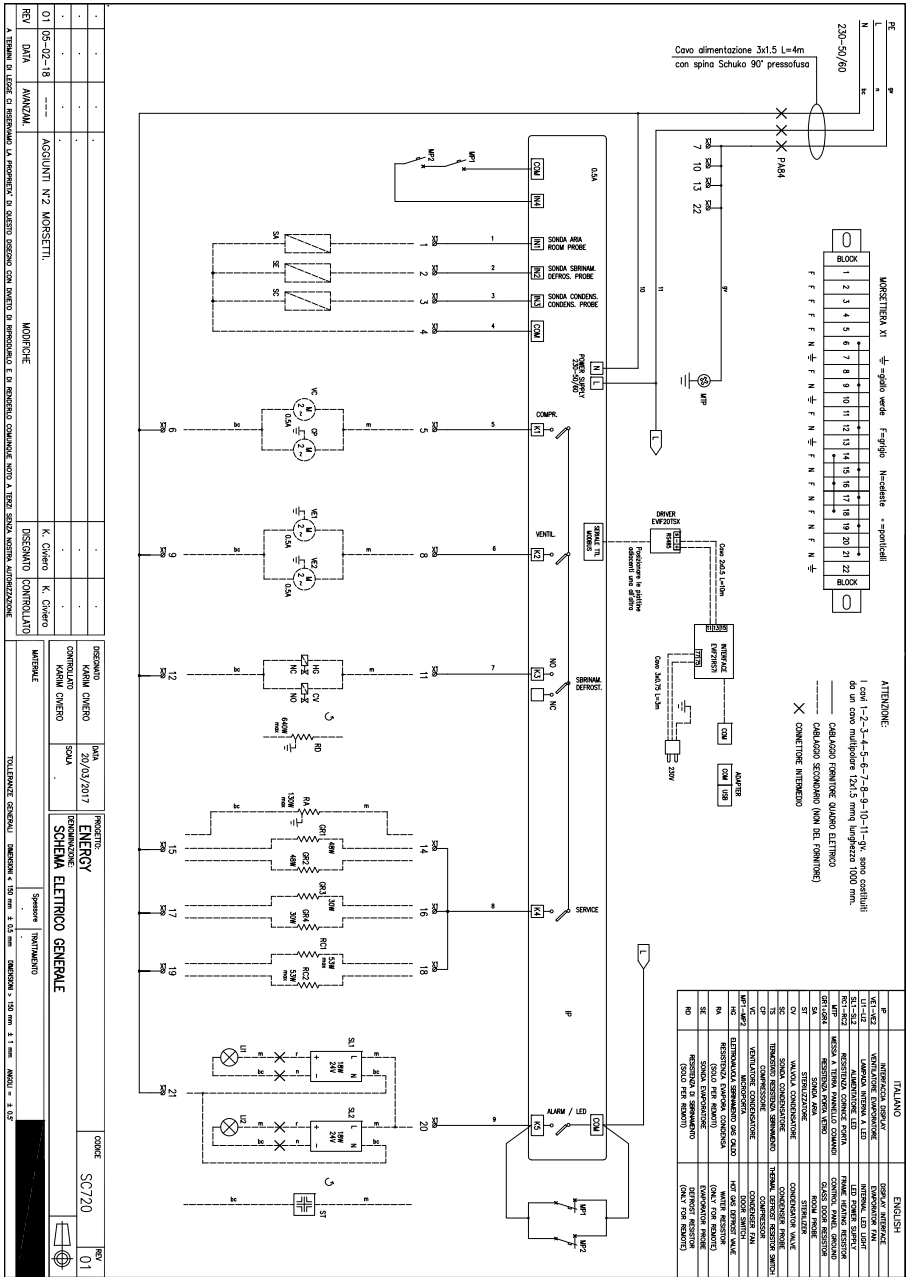

REV.	DATA	MANUALE	MODIFICHE	DISCANTO	CONTROLLO
01	05-02-18	---	AGGIUNTI N°2 MORSELETTI.	K. Chiaro	K. Chiaro

PROGETTO	DATA	REVISIONI	PRODOTTORE
ENERGY	20/03/2017	SC720	SCHEMA ELETTRICO GENERALE

DESCRIZIONE	DATA	PRODOTTORE
SCHEMA ELETTRICO GENERALE	20/03/2017	ENERGY

REVISIONI	DATA	REVISIONI	PRODOTTORE
SC720	01	SC720	01

7E070BC5P002-CABINET 700 BT REM. ENERGY - Content filters: validity 11/09/2018
SC720 - ELECTRICAL WIRING
 Validity: from 23/01/2018

Code	Parts Table	Pos.	Q.ty
72609622	7E070RBC5P002	PRL001	1
72609626	7E070RBC5P002	PRL002	1
73632294	7E070RBC5P002- OPT	HCB001	1
73688080	7E070RBC5P002	LCK008	1
73688646	7E070RBC5P002	FAN011	1
	7E070RBC5P002- OPT	FAN009	1
73691880	7E070RBC5P002	WIR001	1
73692250	7E070RBC5P002- OPT	DRS001	1
74700180	7E070RBC5P002	PIS001	1
74700889	7E070RBC5P002	THE001	1
74700917	7E070RBC5P002	THE002	1
74701161	7E070RBC5P002- OPT	THE003	1
74701641	7E070RBC5P002	GUS001	1
74702570	7E070RBC5P002	WHE001	1
	7E070RBC5P002- OPT	WHE001	1
74703270	7E070RBC5P002	RCK003	1
74703384	7E070RBC5P002- OPT	GRN001	1
74708126	7E070RBC5P002- OPT	LCK006	1
74708202	7E070RBC5P002- OPT	LCK005	1
74755590	7E070RBC5P002- OPT	LMP001	1
74779100	7E070RBC5P002	RCK001	1
74837324	7E070RBC5P002	EVA001	1
74837334	7E070RBC5P002	RST001	1
74837338	7E070RBC5P002	RST002	1
74837340	7E070RBC5P002	HCB002	1

Code	Parts Table	Pos.	Q.ty
	7E070RBC5P002- OPT	HCB001	1
74837398	7E070RBC5P002	RST003	1
74861166	7E070RBC5P002	UCE001	1
78010438	7E070RBC5P002	INT009	1
RIF.TAR.P02	7E070RBC5P002	TAR001	1