

- 541203001 (L-64E)
- 541207201 (R-64E)
- 541203101 (L-64ES)
- 541207301 (R-64ES)
- 541203601 (L-66E)
- 541205401 (LR-66E)
- 541207801 (R-66E)
- 541203701 (L-66ES)
- 541205501 (LR-66ES)
- 541207901 (R-66ES)
- 541204201 (L-68E)
- 541206001 (LR-68E)
- 541208401 (R-68E)
- 541204301 (L-68ES)
- 541206101 (LR-68ES)
- 541208501 (R-68ES)
- 541204801 (L-610E)
- 541206601 (LR-610E)
- 541209001 (R-610E)
- 541204901 (L-610ES)
- 541206701 (LR-610ES)
- 541209101 (R-610ES)

- 541214200 (64)
- 541214400 (66)
- 541214600 (68)
- 541214800 (610)

544023800 (R/LR)

544023901

- 544544600 (64)
- 544544700 (66)
- 544544800 (68)
- 544544900 (610)

544508100
537012800

- 537036200 (64/68/610) ≤ 14070766
- 537036201 (64/68/610) ≥ 14070767
- 537036300 (610) ≤ 14070766
- 537036301 (610) ≥ 14070767
- 537041300 (66) ≤ 14070766
- 537041301 (66) ≥ 14070767

537027400

541133800

- 541104200 (64)
- 541190300 (66)
- 541104300 (68)
- 541190400 (610)

544508000

537036500

533010500

560077600M02P00

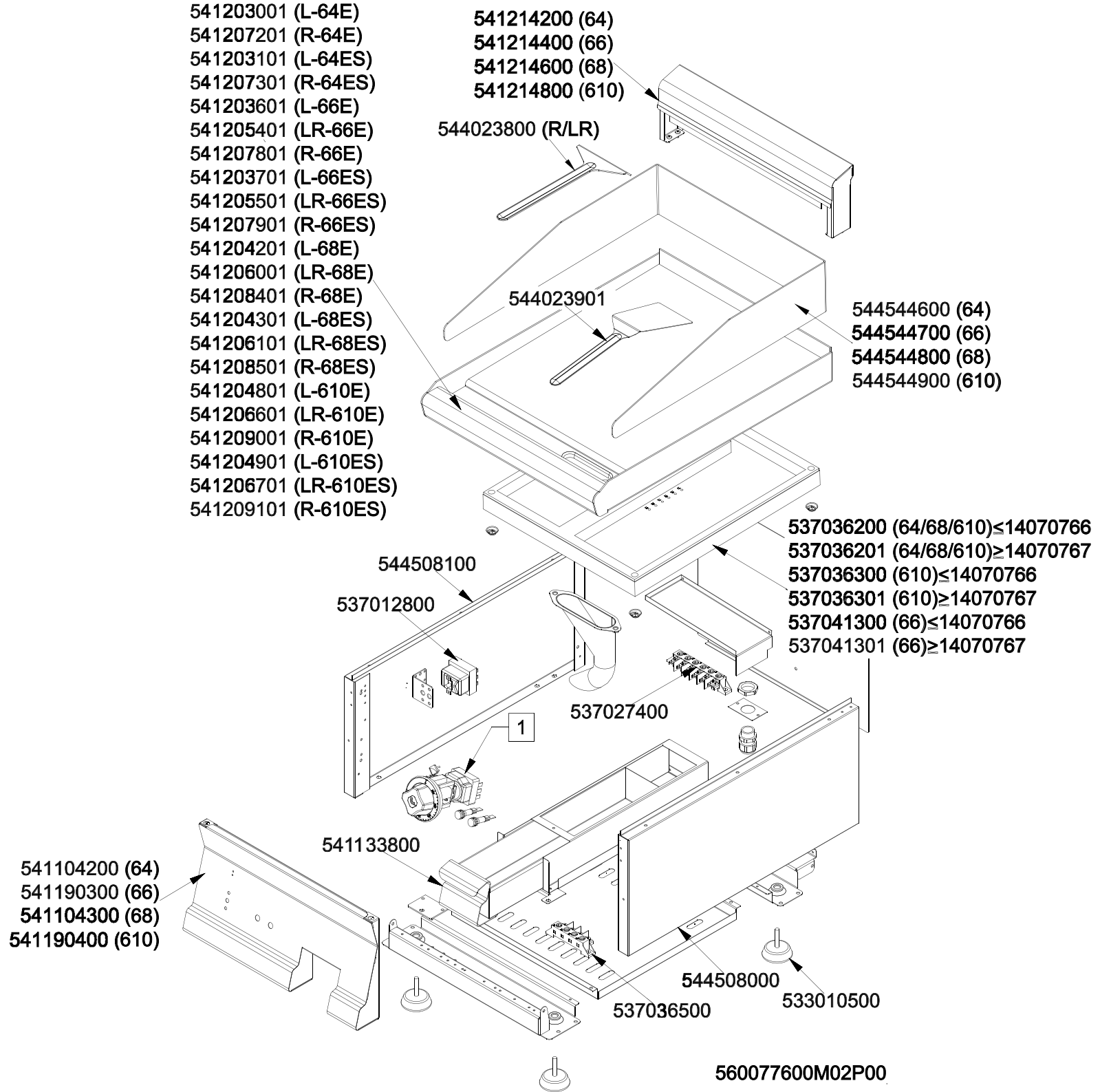

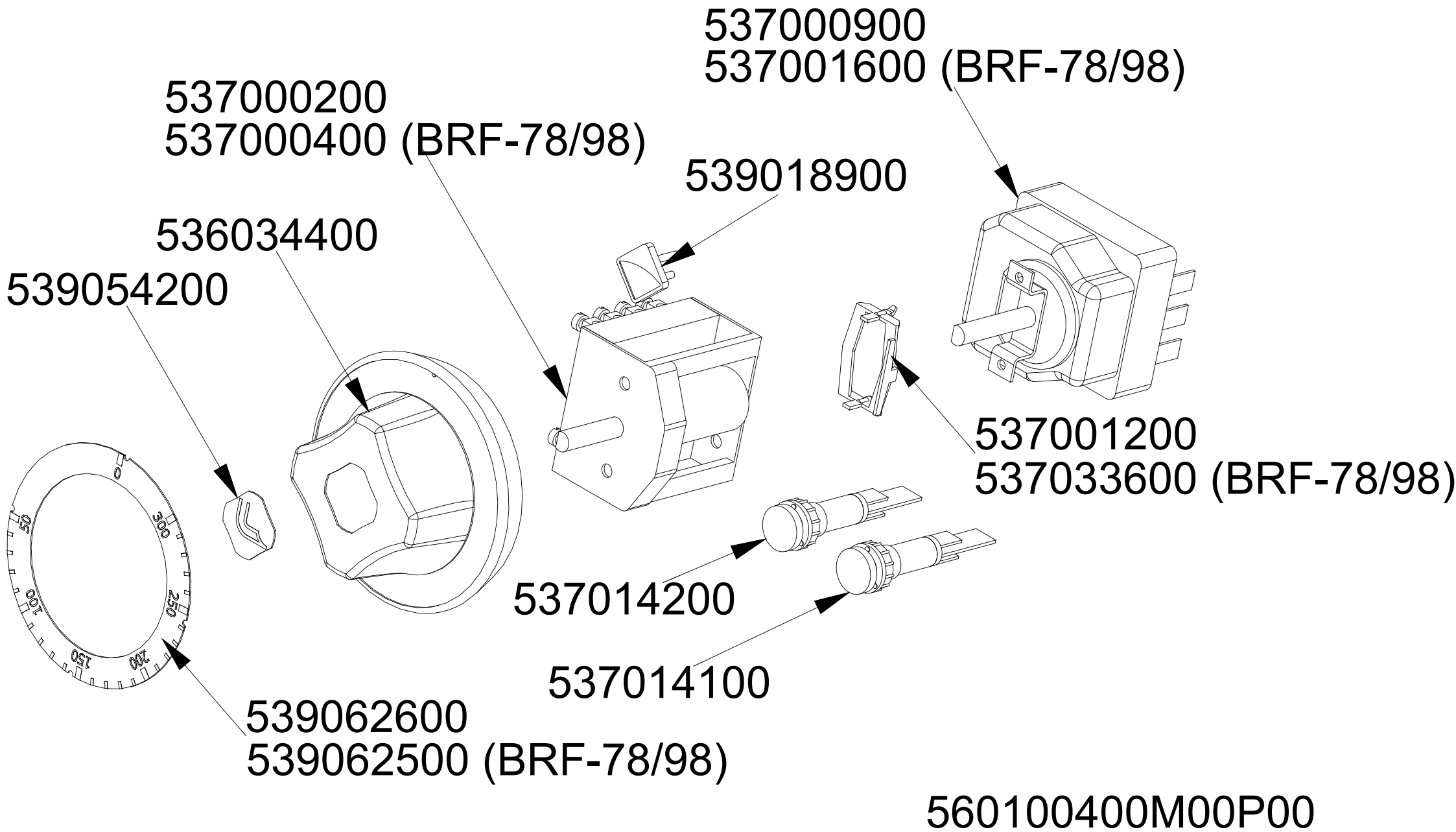

Page	Pos	Code	Description
001		541204201	UPPER PLATE FOR FTL T-6 8E
001		541204301	UPPER PLATE FOR FTL T-6 8ES
001		541214600	SPACER 68E
001		544023901	SPATTLE FOR FRY-TOP
001		544544800	SPLASH GUARD FT-6 8
001		537036200	EL. PLATE 351X428 3600W230V
001		537036201	RES.IRR.351X428 4500W 3-230V
001		544508100	LHD SIDE OF 60T APPLIANCES
001		537012800	SAFETY THERMOSTAT 420°C THREEPHASE
001		537027400	TERMINAL BLOCK THREEPHASE 40A
001		541133800	DRIP TRAY FT-55
001		541104300	CONTROL PANEL FT-78E
001		544508000	RHD SIDE OF 60T APPLIANCES
001		537036500	TERMINAL BLOCK 4POLES 40A SCREW-SCR
001		533010500	LEG M10*25 D.40
002		537000900	THERMOSTAT 063-320°C THREEPHASE
002		537001600	THERMOSTAT 50-320°C SINGLEPHASE
002		537000200	COMMUTATOR 1 POS. 3PHASE S.49 16A
002		537000400	COMMUTATOR 1POS.SINGLEPHASE S49 16A
002		539018900	INDEX FOR KNOB W/RED SIGN
002		536034400	KNOB §77 4P. §06*4,6 C/M
002		539054200	STAMP Ø20,5 CR."L" LOTUS R.
002		537001200	FIXING BRACKET FOR THERMOSTAT/COMM.
002		537033600	FIXING BRACKET FOR THERMOSTAT/COMM.
002		537014200	GREEN WARNING LIGHT 250V
002		537014100	WHITE WARNING LIGHT 250V
002		539062600	RED STICKING DISK 72 (050,300°
002		539062500	RED STICKING DISK 72 (050,300°