

IPERLOTUS 90 TOP

GAS / GAS / GAS / GAZ

FTT..-94G FTT..-98G

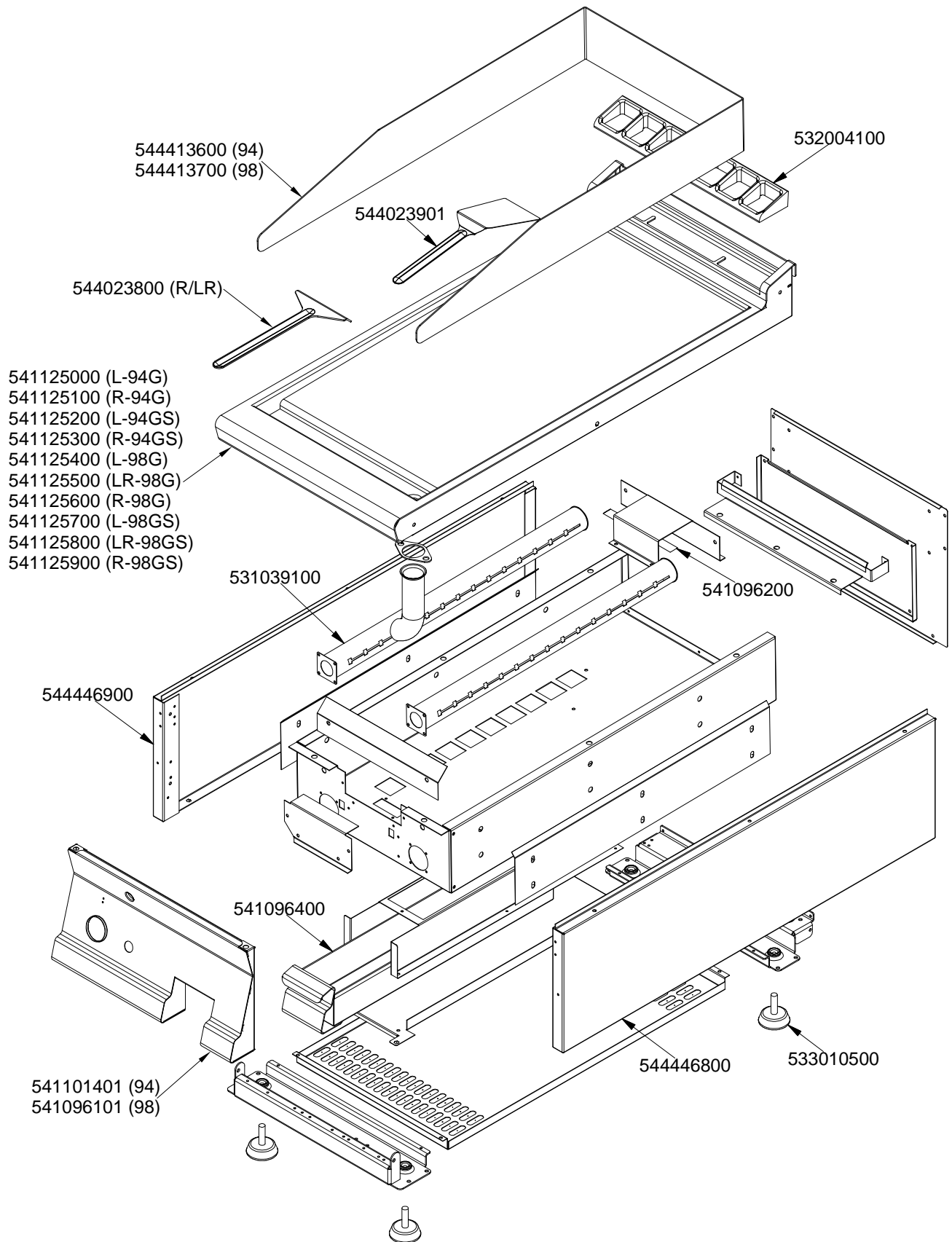

560062800M00P00

IPERLOTUS 90 TOP

GAS / GAS / GAS / GAZ

FTT..-94G FTT..-98G

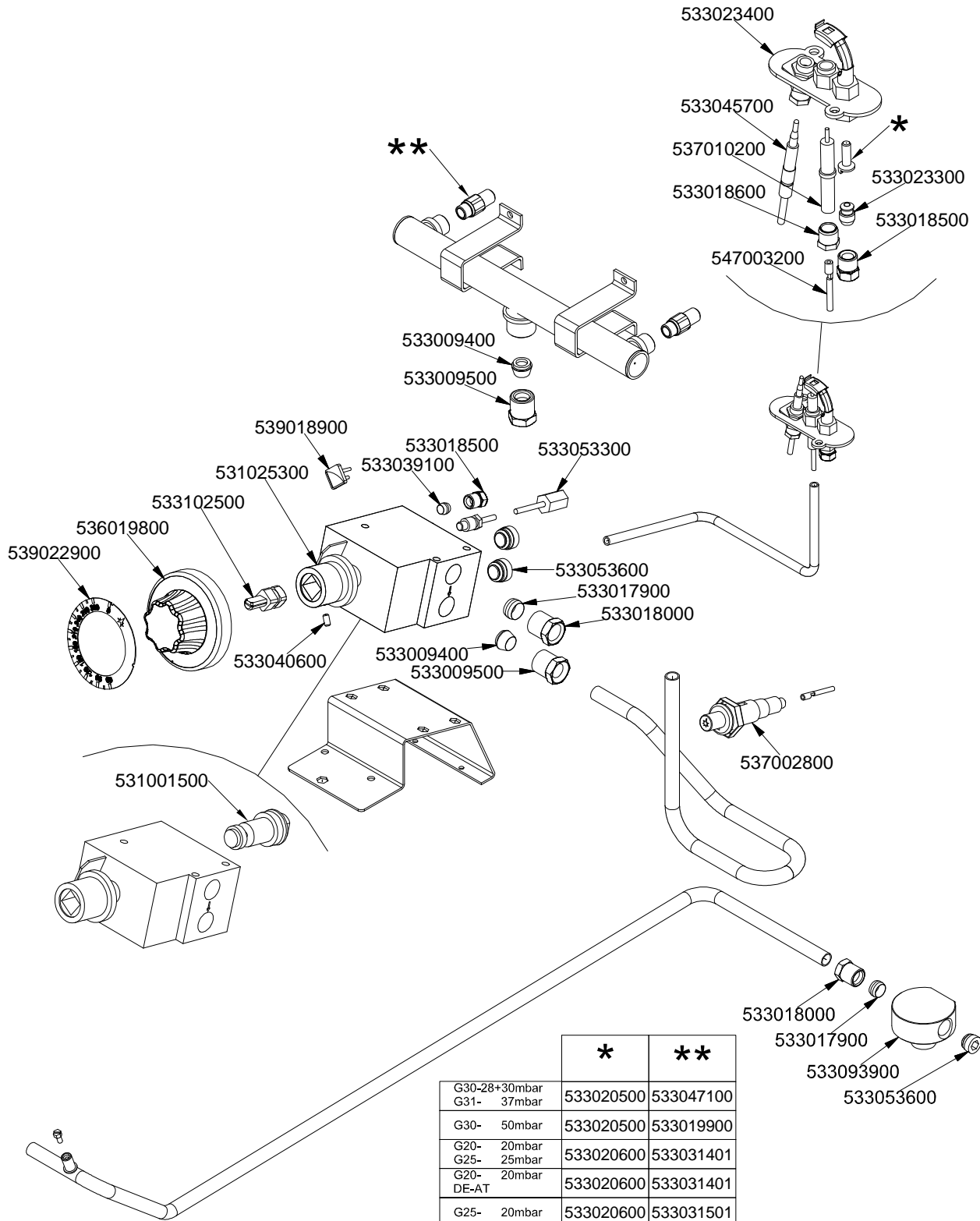

	*	**
G30-28+30mbar	533020500	533047100
G31- 37mbar	533020500	533019900
G30- 50mbar	533020500	533019900
G20- 20mbar	533020600	533031401
G25- 25mbar	533020600	533031401
G20- 20mbar	533020600	533031401
DE-AT	533020600	533031401
G25- 20mbar	533020600	533031501
G25- 25mbar	533020600	533046300
NL	533020600	533046300

560062900M00P00

Page	Pos	Code	Description
001		541125300	UPPER PLATE FTR-94GS
001		544413600	SPLASH GUARD FT-94
001		544023800	
001		541101401	CONTROL PANEL S70/90 FT-74G FT-94G
001		544023901	SPATTLE FOR FRY-TOP
001		544446900	
001		531039100	BURNER FT 90 LINE
001		541096400	DRIP TRAY FT S.70
001		541096200	BURNER SUPPORT FT-74G FT-78G
001		532004100	FLUE GRID L=370 70LINE (RAF)
001		544446800	
001		533010500	LEG M10*25 D.40
002		533020500	NOZZLE 0.140 §19
002		533020600	NOZZLE 0.140 §27
002		533047100	NOZZLE §100A CH12*30 GF-BM6/8
002		533019900	NOZZLE §90 G-FT3 F-FT-B2
002		533031401	NOZZLE §155 CH12X30 G20 MH-B2/FT
002		533031501	NOZZLE §170 CH12X30,0
002		533046300	NOZZLE §160 CH12*30 F-CPM
002		531001500	MAGNET FOR EUROSIT VALVE
002		533009400	BICONE 10S
002		533009500	NIPPLE FOR BICONE 10S
002		539022900	ADHESIVE GRADUATED DISC FOR KNOB
002		536019800	BLACK KNOB §70 PIN §8*6,5
002		533102500	
002		531025300	VALVE EUROSIT FT 100-340°C
002		539018900	INDEX FOR KNOB
002		533039100	BICONE §6
002		533018500	FITTING FOR BICONE D.6 M10*1
002		533040600	HEADLESS SCREW M4*8
002		537002800	PIEZOELECTRIC IGNITION M18
002		533023400	"TARGET" PILOT + NIPPLE TC
002		533045700	THERMOCOUPLE M9*1 500
002		537010200	ROUND PLUG §2,4 - SHORT ELECTRODE
002		533018600	PLUG FITTING
002		533023300	BICONE §6 ("TARGET" PILOT)
002		547003200	HIGH-VOLTAGE CABLE TUBE.§2 L=500
002		533053300	THERMOCOUPLE EXTENSION M9*1
002		533053600	EUROSIT VALVE PLUG
002		533017900	BICONE D.12
002		533018000	ELBOW FOR BICONE D.12 3/8 RS L20