

- 541097700 (L-74G)
- 541097800 (R-74G)
- 541097900 (L-74GS)
- 541098000 (R-74GS)
- 541098100 (L-78G)
- 541098200 (LR-78G)
- 541098300 (R-78G)
- 541098400 (L-78GS)
- 541098500 (LR-78GS)
- 541098600 (R-78GS)
- 541098700 (L-712G)
- 541098800 (LR-712G)
- 541098900 (R-712G)
- 541099000 (L-712GS)
- 541099100 (LR-712GS)
- 541099200 (R-712GS)

- 544181200 (74)
- 544181300 (78)
- 544181400 (712)

532002800

FT..-74G FT..-78G FT..-712G

- 541097300 (74)
- 541097400 (78)
- 541102800 (712)

- 541101400 (74)
- 541096100 (78)
- 541102700 (712)

- 541096200 (74-78)
- 541096300 (712)

531026000

541006900

541096400

544173500

536005200

544173400

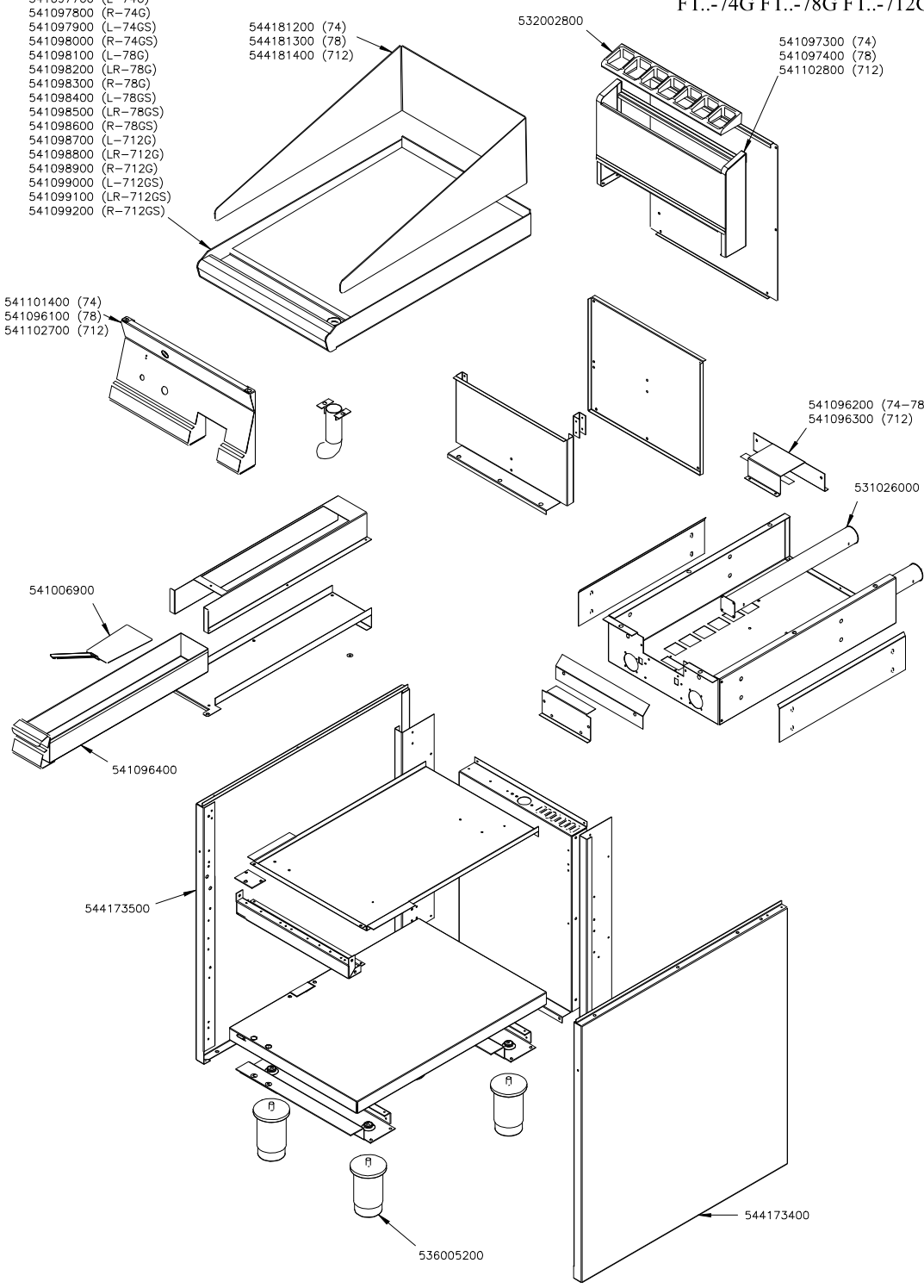

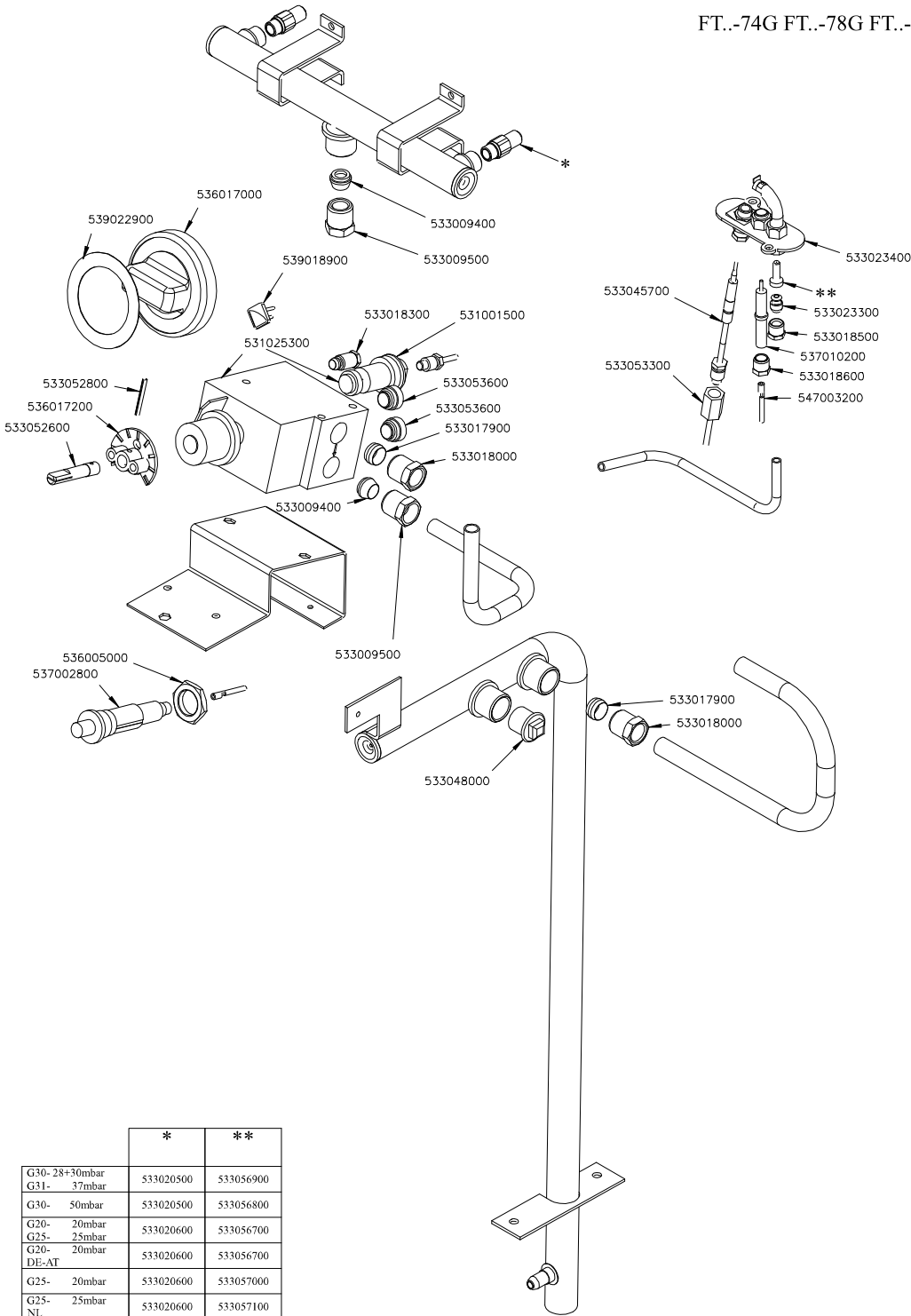

	*	**
G30- 28+30mbar	533020500	533056900
G31- 37mbar		
G30- 50mbar	533020500	533056800
G20- 20mbar	533020600	533056700
G25- 25mbar		
G20- 20mbar	533020600	533056700
DE-AT		
G25- 20mbar	533020600	533057000
G25- 25mbar	533020600	533057100
NL		

Page	Pos	Code	Description
001		541098000	UPPER PLATE FTR-74GS
001		541101400	CONTROL PANEL FT-74G
001		544181200	SPLASH GUARD FT-74
001		532002800	GRID FOR PIPE L=370 S.70
001		541097300	SPACER 74G
001		541096200	BURNER SUPPORT FT-74G FT-78G
001		531026000	BURNER FT-4/6/8G BM-4G
001		541006900	SPATTLE FT
001		541096400	DRIP TRAY FT S.70
001		544173500	LEFT SIDE PANEL S.70
001		536005200	INOX LEG 2" 120-180 M10
001		544173400	RIGHT SIDE PANEL S.70
002		533023400	"TARGET" PILOT + NIPPLE TC
002		533023300	BICONE §6 ("TARGET" PILOT)
002		533018500	FITTING FOR BICONE D.6 M10*1
002		537010200	ROUND PLUG §2,4 - SHORT ELECTRODE
002		533018600	PLUG FITTING
002		547003200	HIGH-VOLTAGE CABLE TUBE.§2 L=500
002		533045700	THERMOCOUPLE M9*1 500
002		533053300	THERMOCOUPLE EXTENSION M9*1
002		533009400	BICONE 10S
002		533009500	NIPPLE FOR BICONE 10S
002		539018900	INDEX FOR KNOB
002		539022900	ADHESIVE GRADUATED DISC FOR KNOB
002		536017000	BLACK KNOB §70 PIN §8*6,5
002		533052800	ELASTIC PEG §2,5*26
002		536017200	MATCHER REMOTE CONTROL EUROSIT
002		533052600	PIN FOR KNOB 65LINE
002		531025300	VALVE EUROSIT FT 100-340°C
002		533018300	FITTING WITH BICONE 6 M10*1
002		531001500	MAGNET FOR EUROSIT VALVE
002		533053600	EUROSIT VALVE PLUG
002		533017900	BICONE D.12
002		533018000	ELBOW FOR BICONE D.12 3/8 RS L20
002		536005000	NUT M18 FOR PIEZOELECTRIC IGNITION
002		537002800	PIEZOELECTRIC IGNITION M18
002		533048000	THREADED CAP 3/8"G
002		533020500	NOZZLE 0.140 §19
002		533056900	NOZZLE §87 CH12*30 G-FT4/8
002		533056800	NOZZLE §77 CH12*30 F-FT4/8
002		533020600	NOZZLE 0.140 §27
002		533056700	NOZZLE §135A CH12*30 M-FT4/8
002		533057000	NOZZLE §150A CH12*30 L-FT4/8
002		533057100	NOZZLE §140A CH12*30 M-FT4/6/8