



Tiefkühlschrank 1400 I, GN 2/1, für Zentralkühlung mit Ventil R404

Artikel-Nr.

90622044 (7E140RBC5P002 / ENERGY 1400BT R R404)

Explosionszeichnung / Ersatzteile

Bitte bei Ersatzteilbestellung immer Artikelnummer und
Seriennummer mit angeben!

7E140RBC5P002-CABINET 1400 TN REM. ENERGY

Content filters: validity 11/09/2018

11/09/2018

7E140RBC5P002 - 7E140RBC5P002-CABINET 1400 TN REM. ENERGY.....	3
7E140RBC5P002-OPT - EXPLODED VIEW OF OPTIONAL PARTS & FEATURES.....	5
SC720 - ELECTRICAL WIRING.....	7
Components index.....	8



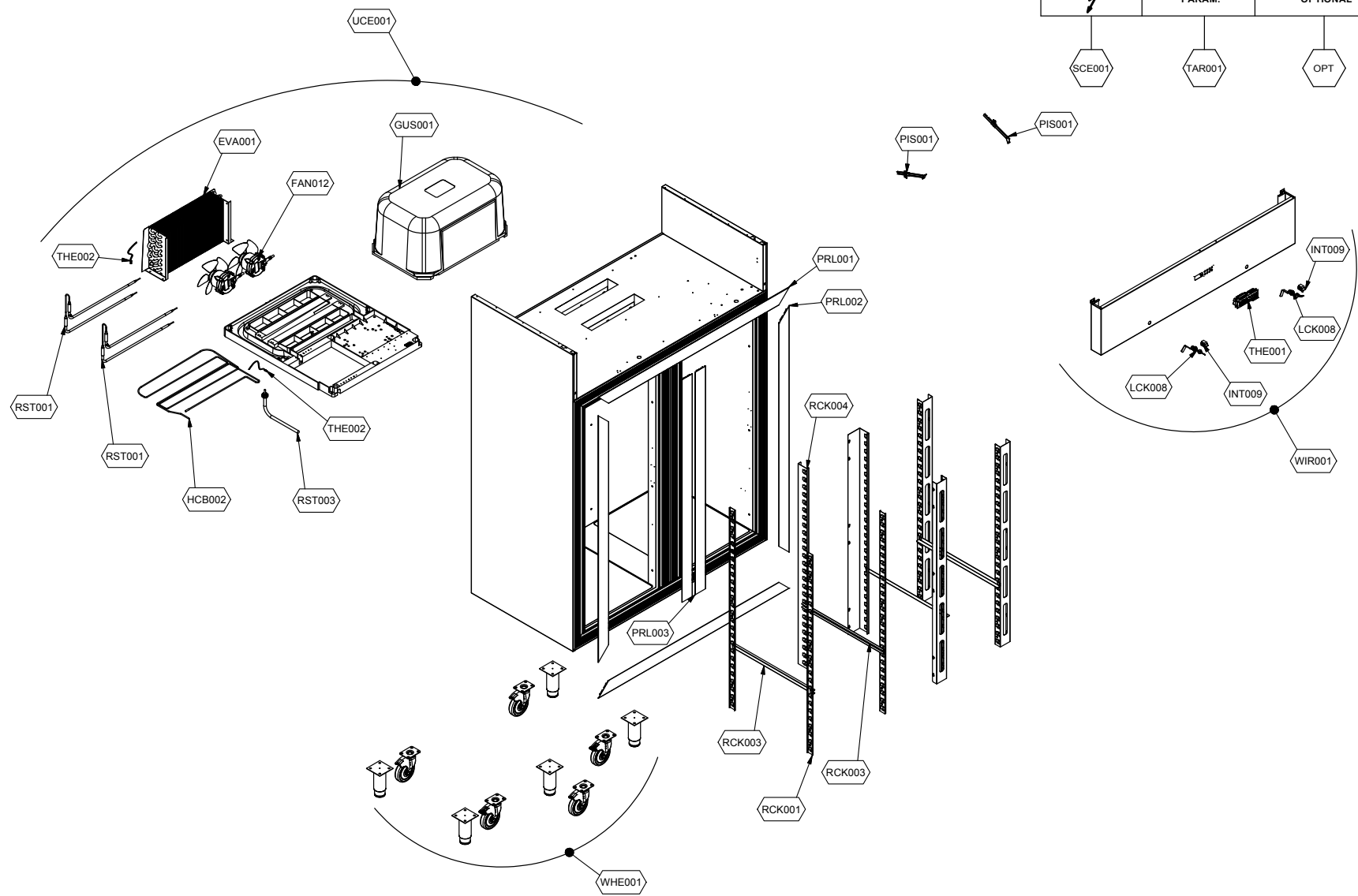









	PARAM.	OPTIONAL
⚡		
SCE001	TAR001	OPT











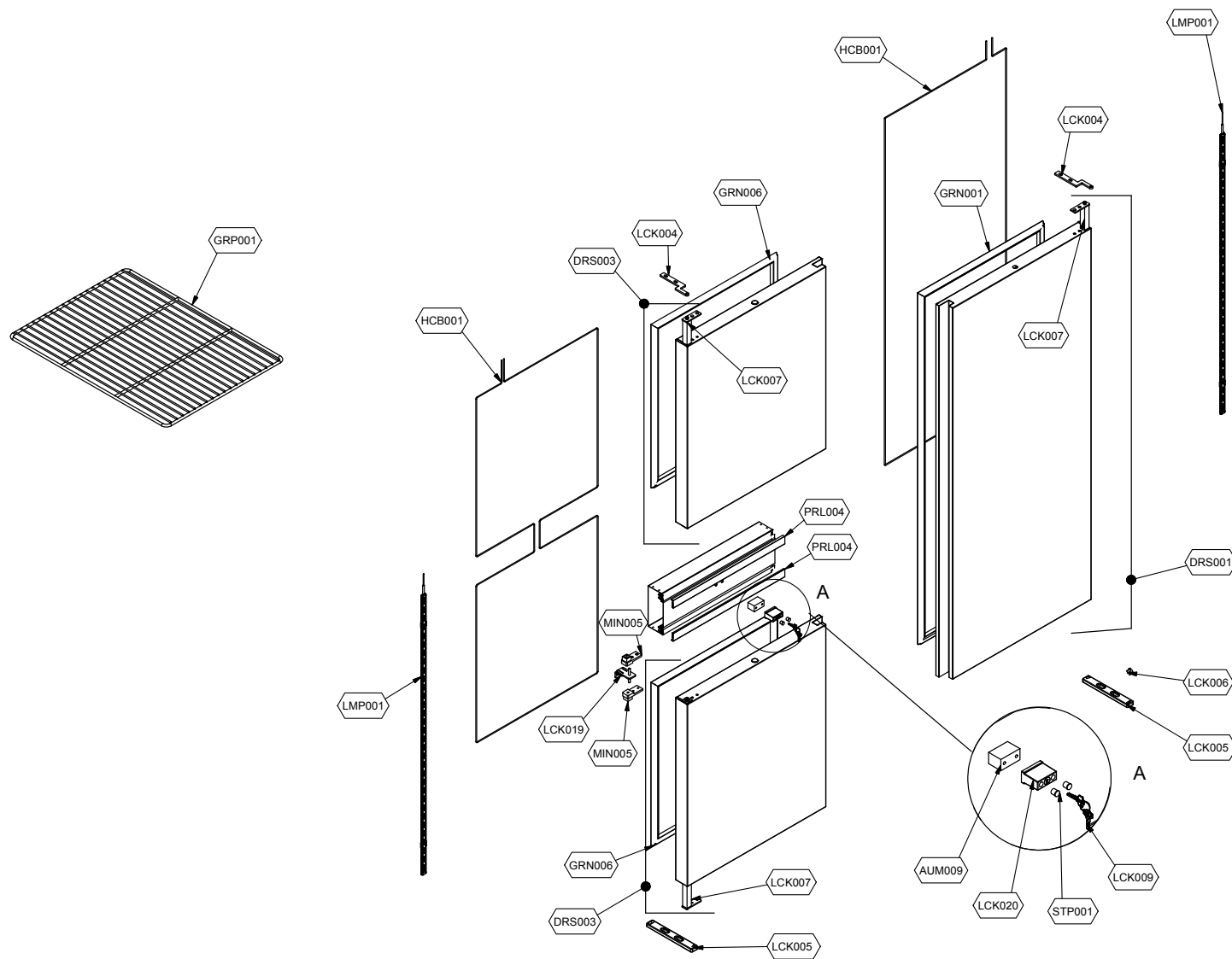

7E140RBC5P002-CABINET 1400 TN REM. ENERGY - Content filters: validity 11/09/2018

7E140RBC5P002 - 7E140RBC5P002-CABINET 1400 TN REM. ENERGY

Validity: from 30/01/2018

Purch.	Pos.	Code	Q.ty	Description	Spare parts after year	Notes
	EVA001	74837352	1	EVAPORATOR	5	
	FAN012	73688648	1	KIT FAN	2	
	GUS001	74701641	1	WARM CABLE		
	HCB002	74837340	1	WARM CABLE		
	INT009	78010438	1	MICROSWITCH	2	
	LCK008	73688080	1	LOCK		
	OPT	7E140RBC5P002- OPT	1	EXPLODED VIEW OF OPTIONAL PARTS & FEATURES		
	PIS001	74700180	1	PISTON	3	
	PRL001	72609642	1	MOBILE HORIZONTAL COVER		
	PRL002	72609626	1	MOBILE VERTICAL COVER		
	PRL003	72609662	1	MOBILE VERTICAL COVER		
	RCK001	74779100	1	UNIVERSAL RACK		
	RCK003	74703270	1	RIGHT RUNNER		
	RCK004	74779108	1	BACK RACK		
	RST001	74837334	1	HEATING ELEMENT	2	
	RST003	74837398	1	HEATING ELEMENT	2	
	SCE001	SC720	1	ELECTRICAL WIRING	1	
	TAR001	RIF.TAR.P04	1	CONTROLLER PRESETTING SERVICE	1	
	THE001	74700889	1	UNSETTED ELECTRONIC CONTROLLER	1	
	THE002	74700917	1	PROBE	1	
	UCE001	74861168	1	FULL CONDENSING UNIT		
	WHE001	74702570	1	CASTOR/FEET		
	WIR001	73691882	1	ELECTRICAL PANEL		



Purch.	Pos.	Code	Q.ty	Description	Spare parts after year	Notes
	DRS001	73692250	1	DOOR		
	FAN009	73688648	1	KIT FAN	2	
	GRN001	74703384	1	GASKET	2	
	HCB001	74837340	1	WARM CABLE		
	HCB001	73632294	1	WARM CABLE		
	LCK005	74708202	1	LOWER DOOR SUPPORT		
	LMP001	74755590	1	LED LIGHTING		
	THE003	74701161	1	LED POWER PACK	1	
	WHE001	74702570	1	CASTOR/FEET		

Code	Parts Table	Pos.	Q.ty
72609626	7E140RBC5P002	PRL002	1
72609642	7E140RBC5P002	PRL001	1
72609662	7E140RBC5P002	PRL003	1
73632294	7E140RBC5P002- OPT	HCB001	1
73688080	7E140RBC5P002	LCK008	1
73688648	7E140RBC5P002	FAN012	1
	7E140RBC5P002- OPT	FAN009	1
73691882	7E140RBC5P002	WIR001	1
73692250	7E140RBC5P002- OPT	DRS001	1
74700180	7E140RBC5P002	PIS001	1
74700889	7E140RBC5P002	THE001	1
74700917	7E140RBC5P002	THE002	1
74701161	7E140RBC5P002- OPT	THE003	1
74701641	7E140RBC5P002	GUS001	1
74702570	7E140RBC5P002	WHE001	1
	7E140RBC5P002- OPT	WHE001	1
74703270	7E140RBC5P002	RCK003	1
74703384	7E140RBC5P002- OPT	GRN001	1
74708202	7E140RBC5P002- OPT	LCK005	1
74755590	7E140RBC5P002- OPT	LMP001	1
74779100	7E140RBC5P002	RCK001	1
74779108	7E140RBC5P002	RCK004	1
74837334	7E140RBC5P002	RST001	1
74837340	7E140RBC5P002	HCB002	1
	7E140RBC5P002- OPT	HCB001	1
74837352	7E140RBC5P002	EVA001	1

Code	Parts Table	Pos.	Q.ty
74837398	7E140RBC5P002	RST003	1
74861168	7E140RBC5P002	UCE001	1
78010438	7E140RBC5P002	INT009	1
RIF.TAR.P04	7E140RBC5P002	TAR001	1