



cookmax 

Snackgeräte Mikrowelle

Artikel-Nr.
90213011 (NE-1027)

Explosionszeichnung / Ersatzteile

Bitte bei Ersatzteilbestellung immer Artikelnummer und Seriennummer mit angeben!

10 EXPLODED VIEW AND PARTS LIST

10.1. EXPLODED VIEW

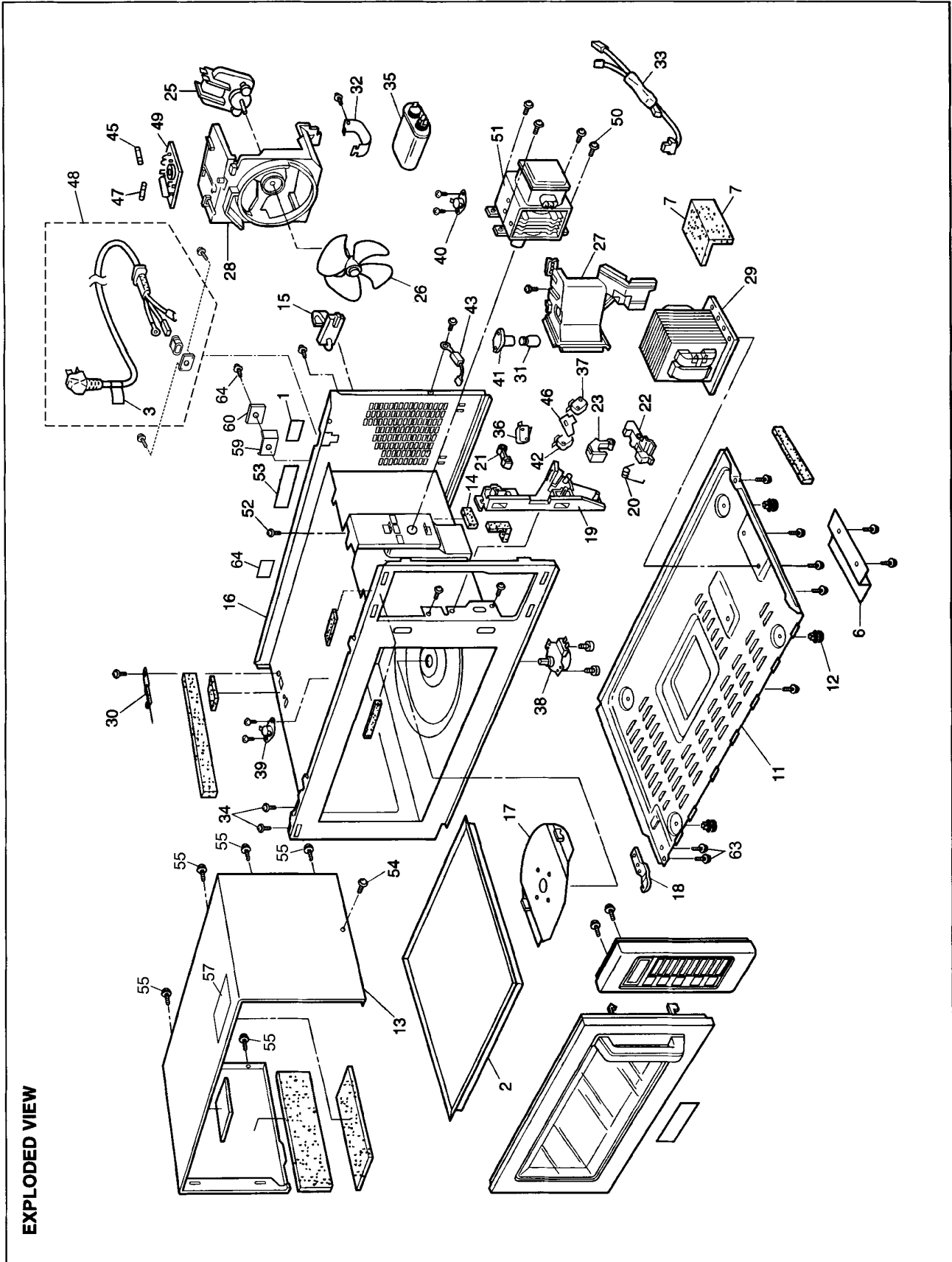

10.2. PARTS LIST

NOTE:

1. When ordering replacement part(s), please use part number(s) shown in this part list.

Do not use description of the part.

2. Important safety notice:

Components identified by \triangle mark have special characteristics important for safety.

When replacing any of these components, use only manufacture's specified parts.

Ref. No.		Part No.	Part Name & Description	Pcs/Set	Remarks
1		Z00064080BP	CAUTION LABEL	1	BTQ
1		Z00068K30EU	CAUTION LABEL	1	ETG
2		Z010T3700BP	SHELF	1	
3		Z02395G50BP	CORD LABEL	1	BTQ
6		Z10403700BP	BASE BRACKET	1	
7		Z0912000FF	CUSHION RUBBER B	2	
11		Z10013700BP	BASE	1	
12		Z1008-1180	RUBBER FOOT	4	
13		Z11553700BP	CABINET BODY (U)	1	INCLUDING CUSHION RUBBER & INSULATION SHEET
14		Z10498K30BP	CUSHION RUBBER	1	
15		Z11406V00HP	STOPPER	1	
16	\triangle	Z200A3700GP	OVEN CAVITY	1	
17		Z203P3700BP	ANTENNA (U)	1	
18		Z30073700BP	LOWER HINGE	1	
19	\triangle	Z3020-1480	DOOR HOOK A	1	
20		Z3097-1480	SPRING	1	
21		Z3136-1480	HOOK SPACER A	1	
22		Z3137-1480	HOOK SPACER B	1	
23		Z3138-1480	HOOK SPACER C	1	
25	\triangle	Z400A3700BP	FAN MOTOR	1	
26		Z4008-1480	FAN BLADE	1	
27		Z40253700BP	AIR GUIDE A	1	
28		Z41445540AP	ORIFICE	1	
29	\triangle	Z622B3700HN	H.V.TRANSFORMER	1	
30	\triangle	Z030F8K30BP	TEMP SENSOR W/LEAD WIRE (U)	1	1037 BTQ/ETG (INCLUDING OVEN TEMP SENSOR)
31		Z60304080BP	INCANDESCENT LAMP	1	
32		Z6037-3700	CAPACITOR BRACKET	1	
33		Z606V3700BP	PROTECTOR DIODE (U)	1	
34		ZYFBFE4+AF8	SCREW	2	FOR UPPER HINGE
35	\triangle	Z60903700GP	H.V.CAPACITOR	1	
36	\triangle	Z6142-1450	MICRO SWITCH	1	(V-16G-3C26-M) PRIMARY LATCH SWITCH
37	\triangle	Z6142-1450	MICRO SWITCH	1	1027 BTQ/ETG (V-16G-3C26-M) PRIMARY LATCH SWITCH
37	\triangle	Z61425180AP	MICRO SWITCH	1	1037 BTQ/ETG (L-3C2-2) SECONDARY LATCH SWITCH
38	\triangle	Z61443660AP	ANTENNA MOTOR	1	
39	\triangle	Z61454000AP	THERMAL CUTOUT	1	1027 BTQ/ETG (FOR OVEN)
40	\triangle	Z61455840GP	THERMAL CUTOUT	1	(FOR MAGNETRON)
41		Z61524000AP	SOCKET	1	
42	\triangle	ZNE6161-3X0	MICRO SWITCH	1	(V-16G-2C25) SHORT SWITCH
43		Z6202-3280	DIODE,SI	1	
45	\triangle	Z62304210BP	FUSE	1	(10A)
46		Z63064000AP	INSULATION SHEET R	1	1027 BTQ/ETG
47	\triangle	Z65953700BP	FUSE B	1	(2.5A)
48	\triangle	Z910C3700BP	AC CORD W/PLUG (U)	1	BTQ (NOT INCLUDING CORD LABEL)
48	\triangle	Z910C3710GP	AC CORD W/PLUG (U)	1	ETG
49		Z692Y3710BP	NOISE FILTER (U)	1	1027 BTQ/ETG
49		Z692Y3700BP	NOISE FILTER (U)	1	1037 BTQ/ETG
50		ZTWFA4+12T	SCREW	4	FOR MAGNETRON
51	\triangle	Z2M244-M6J1P	MAGNETRON	1	
52		ZYDFB4+EE12F	SCREW	1	FOR EARTH
53		Z00078K40SBP	NAME PLATE	1	1027 BTQ
53		Z00078K40SEU	NAME PLATE	1	1027 ETG
53		Z00078K30SBP	NAME PLATE	1	1037 BTQ
53		Z00078K30SEU	NAME PLATE	1	1037 ETG
54		ZTC4+12BC	SCREW	1	FOR CABINET BODY SIDE
55		ZTWAFE4+8S	SCREW	5	FOR CABINET BODY
57		Z00958K30BP	CAUTION LABEL B	1	BTQ
57		Z00958K30EU	CAUTION LABEL B	1	ETG
59		ZWNANE65GV	BRACKET	1	
60		Z66623170GP	EARTH BRACKET	1	
63		ZTWFA4+12LR	SCREW	2	FOR LOWER HINGE
64		ZYF6+F20FUJ	SCREW	1	

10.3. DOOR ASSEMBLY

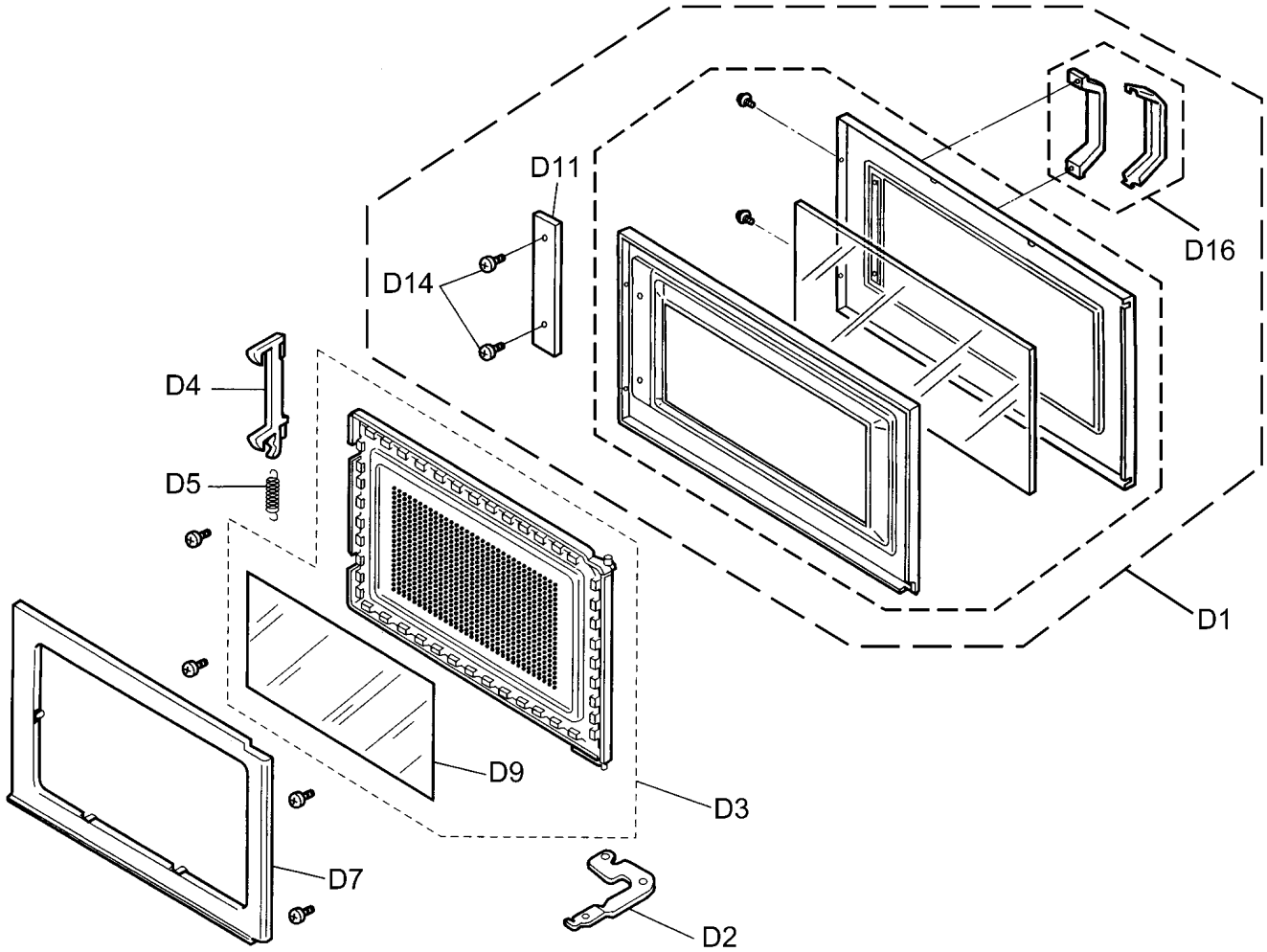

Ref. No.		Part No.	Part Name & Description	Pcs/Set	Remarks
D1	⚠	Z302A3700SHP	DOOR A (U)	1	1037 BTQ/ETG (INCLUDING DOOR PANEL)
D1	⚠	Z302A3710SBP	DOOR A (U)	1	1027 BTQ/ETG (INCLUDING DOOR PANEL)
D2		Z30063700BP	UPPER HINGE	1	
D3	⚠	Z302K3700BP	DOOR E (U)	1	
D4		Z3018-1480	DOOR KEY A	1	
D5		Z30214000AP	DOOR KEY SPRING	1	
D7	⚠	Z30858960HN	DOOR C	1	
D9		Z31453700BP	DOOR SCREEN A	1	
D11		Z32863700AP	HANDLE SPACER	1	
D14		ZTN4+16Q	SCREW	2	
D16		Z301F6P00AP	HANDLE (U)	1	

10.4. ESCUTCHEON BASE ASSEMBLY

10.4.1. NE-1037

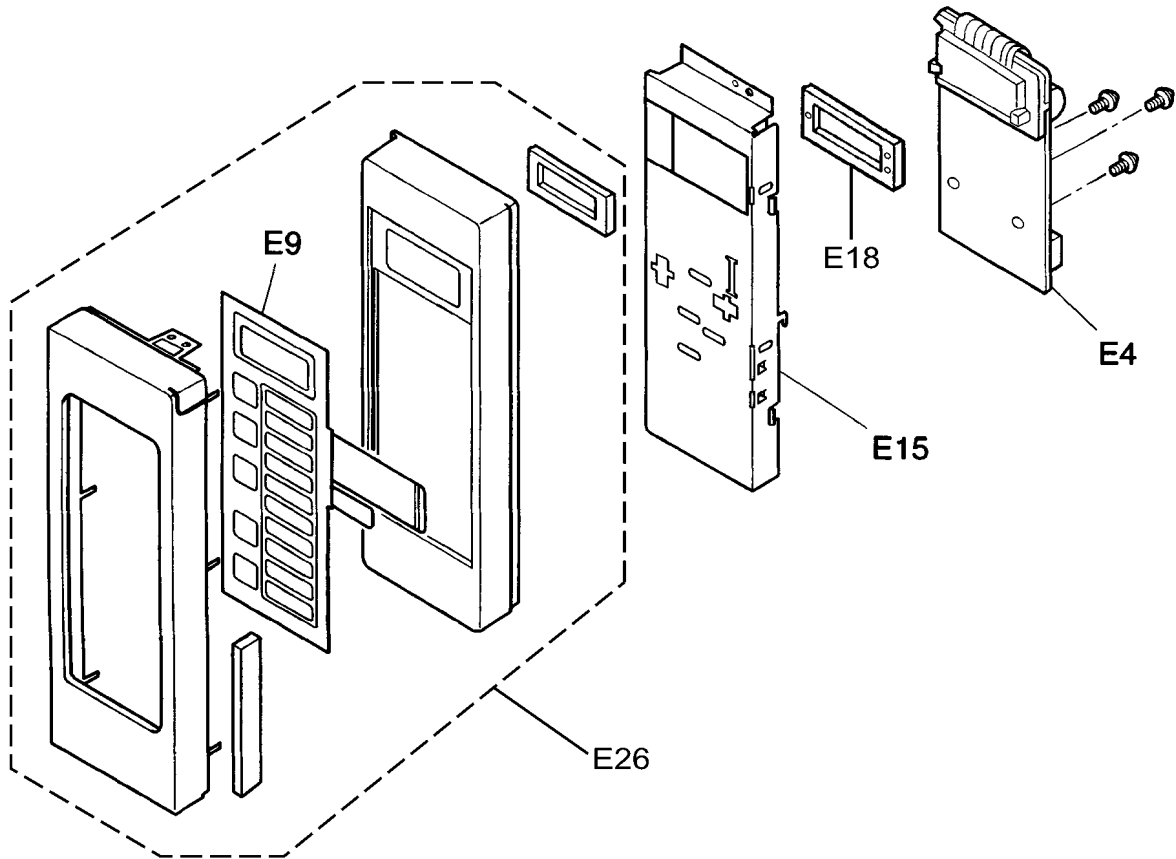

Ref. No.	Part No.	Part Name & Description	Pcs/Set	Remarks
E4	Z603L3700EU	D.P.CIRCUIT (U)	1	1037 BTQ/ETG
E9	Z630Y8K30BP	MEMBRANE SWITCH (U)	1	1037 BTQ/ETG
E15	Z81273700AP	BACK PANEL	1	1037 BTQ/ETG
E18	Z83428K30BP	CUSHION RUBBER B	1	1037 BTQ/ETG
E26	Z800L8K30BP	ESCUTCHEON BASE (U)	1	1037 BTQ/ETG

10.4.2. NE-1027

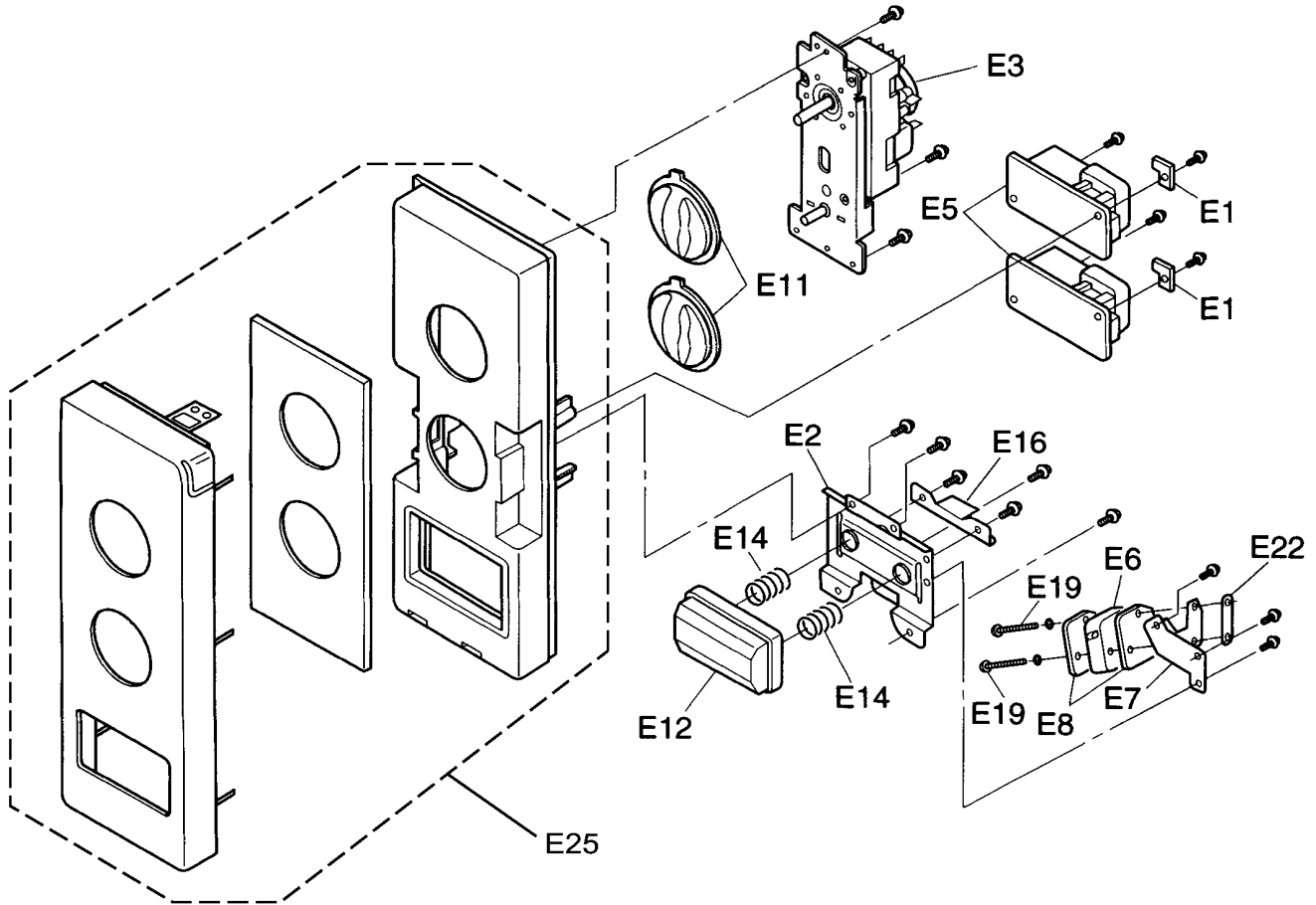

Ref. No.	Part No.	Part Name & Description	Pcs/Set	Remarks
E1	Z62383710BP	SPACER	2	1027 BTQ/ETG
E2	Z600X8K40BP	START SWITCH BRACKET	1	1027 BTQ/ETG
E3	Z60018060BP	TIMER	1	1027 BTQ/ETG
E5	Z606X3710BP	INRUSH REDUCING CIRCUIT	2	1027 BTQ/ETG
E6	Z6142-1450	MICRO SWITCH	1	1027 BTQ/ETG
E7	Z61623710BP	START SWITCH BRACKET	1	1027 BTQ/ETG
E8	ZNE6306910AP	INSULATION SHEET R	2	1027 BTQ/ETG
E11	Z80203710BP	TIMER KNOB	2	1027 BTQ/ETG
E12	ZNE8024P00RN	COOK BUTTON	1	1027 BTQ/ETG
E14	ZNE8037P00RN	COOK BUTTON SPRING	2	1027 BTQ/ETG
E16	Z81903710BP	COOK LEVER	1	1027 BTQ/ETG
E19	ZTN3+F16S	SCREW	1	1027 BTQ/ETG
E22	Z6633P60AP	SPACER B	1	1027 BTQ/ETG
E25	Z800L8K40BP	ESCUTCHEON BASE (U)	1	1027 BTQ/ETG

10.5. PACKING AND ACCESSORIES

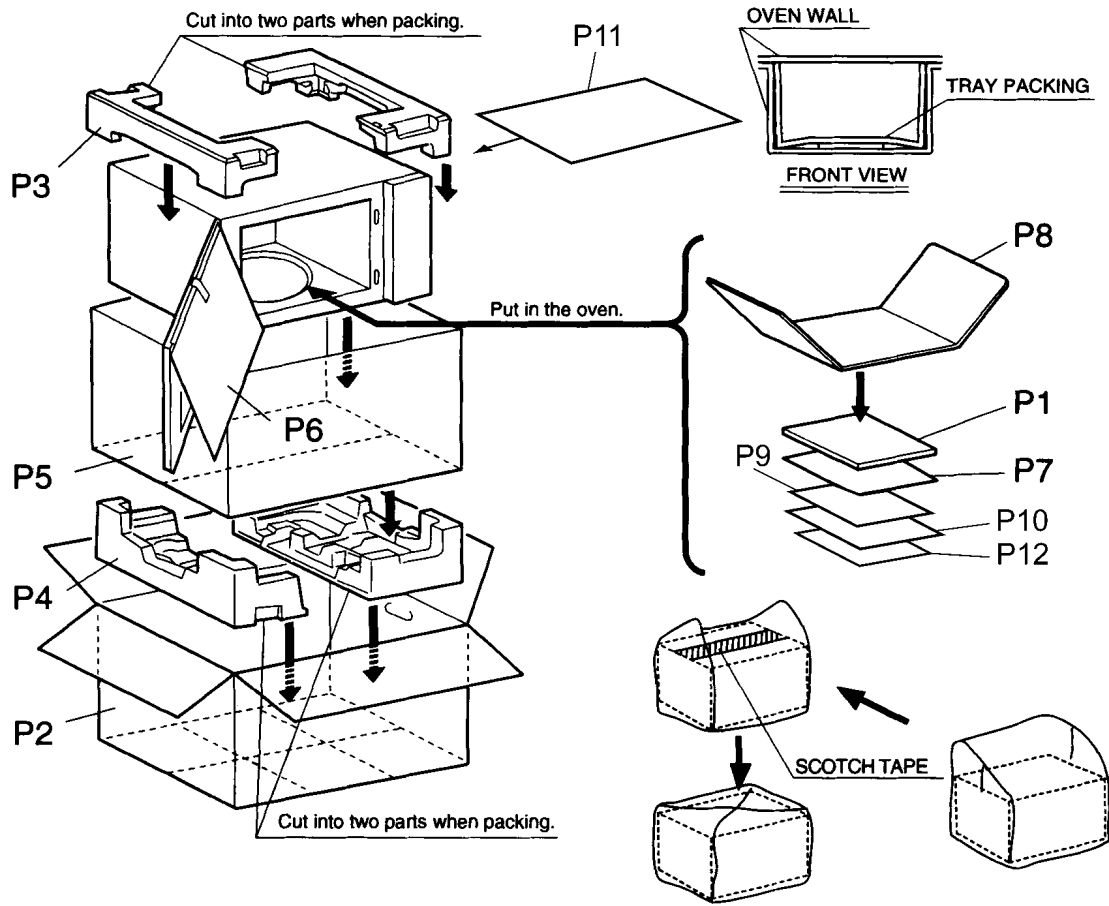

Ref. No.	Part No.	Part Name & Description	Pcs/Set	Remarks
P1	Z00033700BP	INSTRUCTION BOOK	1	1027BTQ, 1037BTQ
P1	Z00033700EU	INSTRUCTION BOOK	1	1027ETG, 1037ETG
P2	Z01028K40BP	PACKING CASE, PAPER	1	1027 BPQ
P2	Z01028K40EU	PACKING CASE, PAPER	1	1027 ETG
P2	Z01028K30BP	PACKING CASE, PAPER	1	1037 BPQ
P2	Z01028K30EU	PACKING CASE, PAPER	1	1037 ETG
P3	Z01048K30BP	UPPER FILLER	1	
P4	Z01058K30BP	LOWER FILLER	1	
P5	Z01068K00AP	VINYL COVER	1	
P6	Z01078100XN	DOOR SHEET	1	
P7	Z04203700BP	OPERATING GUIDE	1	1037 BTQ
P8	Z01088K30BP	TRAY PACKING	1	
P9	Z01568K30BP	CAUTION	1	BTQ
P10	Z01728K30BP	CAUTION LABEL	1	BTQ
P10	Z01728K30EU	CAUTION LABEL	1	ETG
P11	Z01924T00AP	SHEET	1	
P12	Z02843560BP	NO. LABEL	1	BTQ

10.6. WIRING MATERIALS

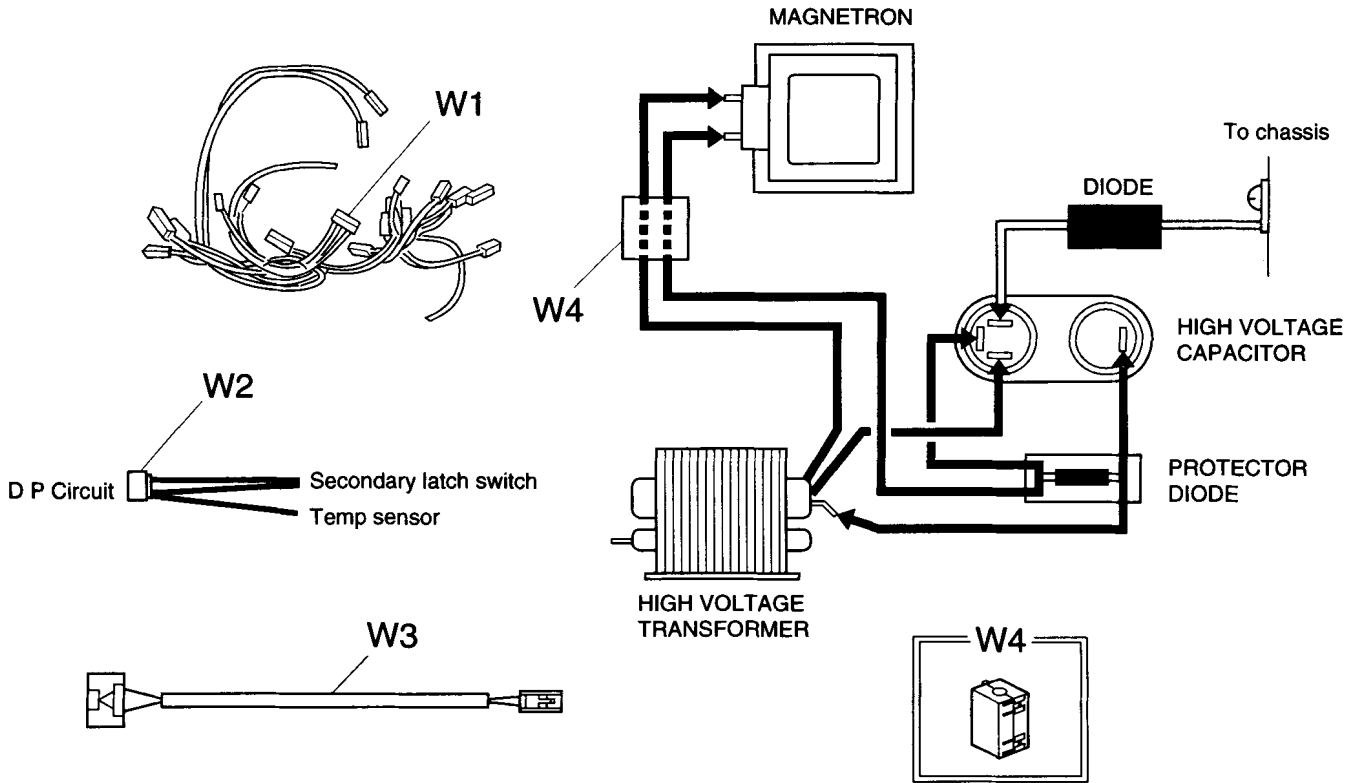

Ref. No.	Part No.	Part Name & Description	Pcs/Set	Remarks
W1	Z030A8K40BP	LEAD WIRE HARNESS	1	1027 BTQ/ETG
W1	Z030A8K30BP	LEAD WIRE HARNESS	1	1037 BTQ/ETG
W2	Z03538K30BP	LEAD WIRE	1	1037 BTQ/ETG
W3	Z03558K30BP	LEAD WIRE	1	
W4	Z50966520UP	FERRITE CORE	1	
33	Z606V3700BP	PROTECTOR DIODE (U)	1	