

**Bar
Getränkemixer**

Artikel-Nr. 721006 (FR1P)

Explosionszeichnung / Ersatzteile

Bitte bei Ersatzteilbestellung immer Seriennummer mit angeben!

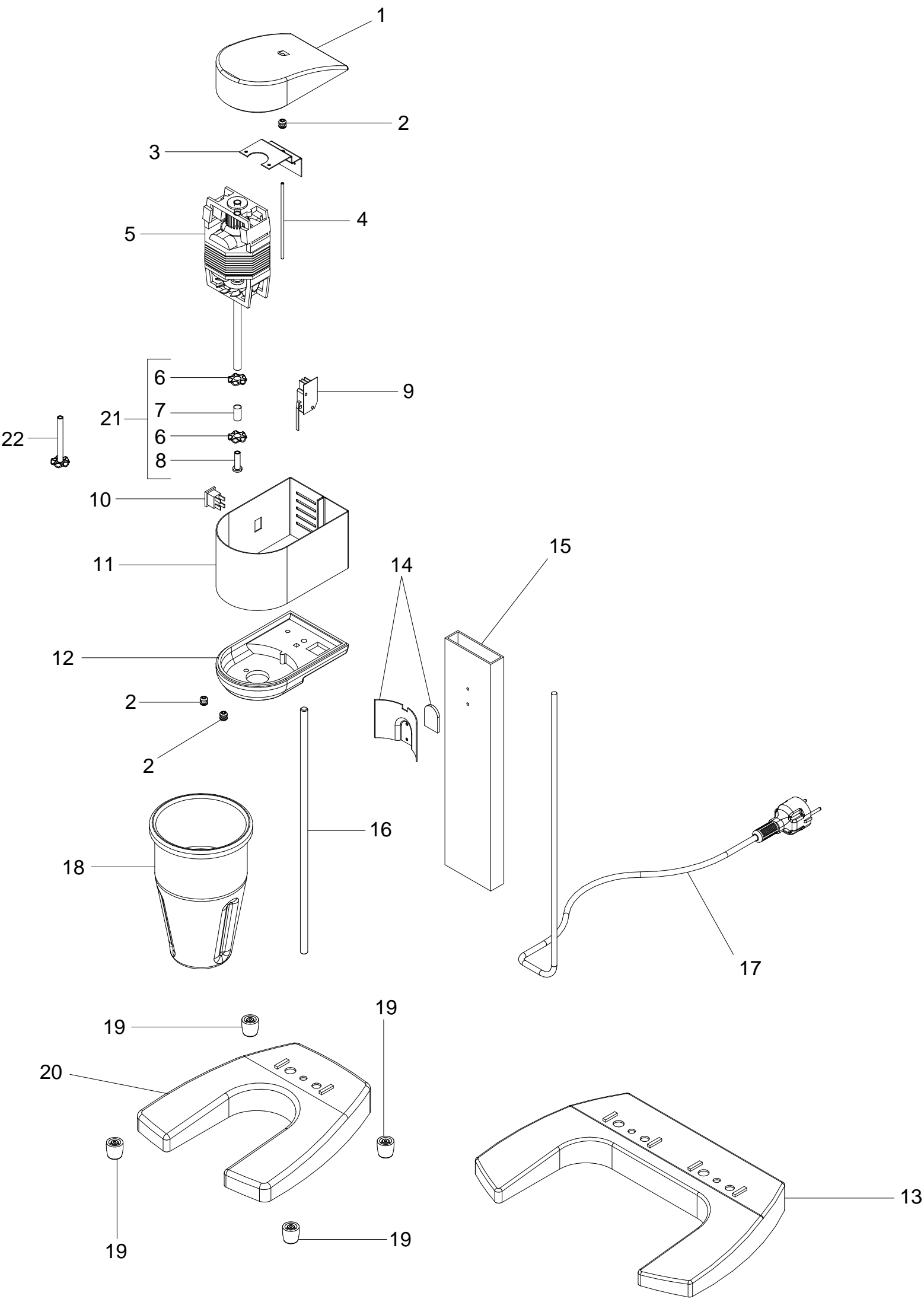

FR1G-2G-FR1P-2P

Pos. Ref.	Codice Code		Caratteristiche Features	Descrizione Description	
1	CO1670			Copertura	Covering
2	CO1658			Distanziale	Spacer
3	CO1668			Supporto	Support
4	CO1667			Distanziale	Spacer
5	CO1665		230V/1Ph/50-60Hz	Motore	Motor
6	CO1664		01/01/03 f.p.(*)	Ventola	Fan
7	CO1663		01/01/03 f.p.(*)	Boccola	Bush
8	CO1662		01/01/03 f.p.(*)	Inserto	Insert
9	CO1666	●		Microinterruttore	Microswitch
10	CO1661	●		Interruttore	Switch
11	CO1660			Carcassa	Housing
12	CO1659			Coperchio	Cover
14	CO1496			Supporto	Support
15	CO1495			Supporto	Support
16	CO1493			Tubo	Tube
17	CO1494		1Ph+N+Gnd	Cavo elettrico	Electric cable
18	CO1076		(FR1G-2G) Stainless steel	Contenitore	Tank
18	CO1492	●	(FR1P-2P) Plastic	Contenitore	Tank
19	CO1460			Piedino	Foot
21	CO1934		01/01/03 f.p.(*) Assembly - Stainless steel	Mescolatore	Mixer
22	CO2816	●	Plastic	Mescolatore	Mixer

(*) : fuori produzione / out of production

● : ricambio consigliato / spare part suggested