

ELETTROBAR

**SPARE PARTS CATALOGUE
ERSATZTEILKATALOG
CATALOGUE PIECES DETACHEES
CATALOGO PARTI RICAMBIO
CATALOGO DE PIEZAS DE RECAMBIO
CATALOGO PEÇAS DE REPOSIÇÃO**

Niagara-261

03-09-2012

1

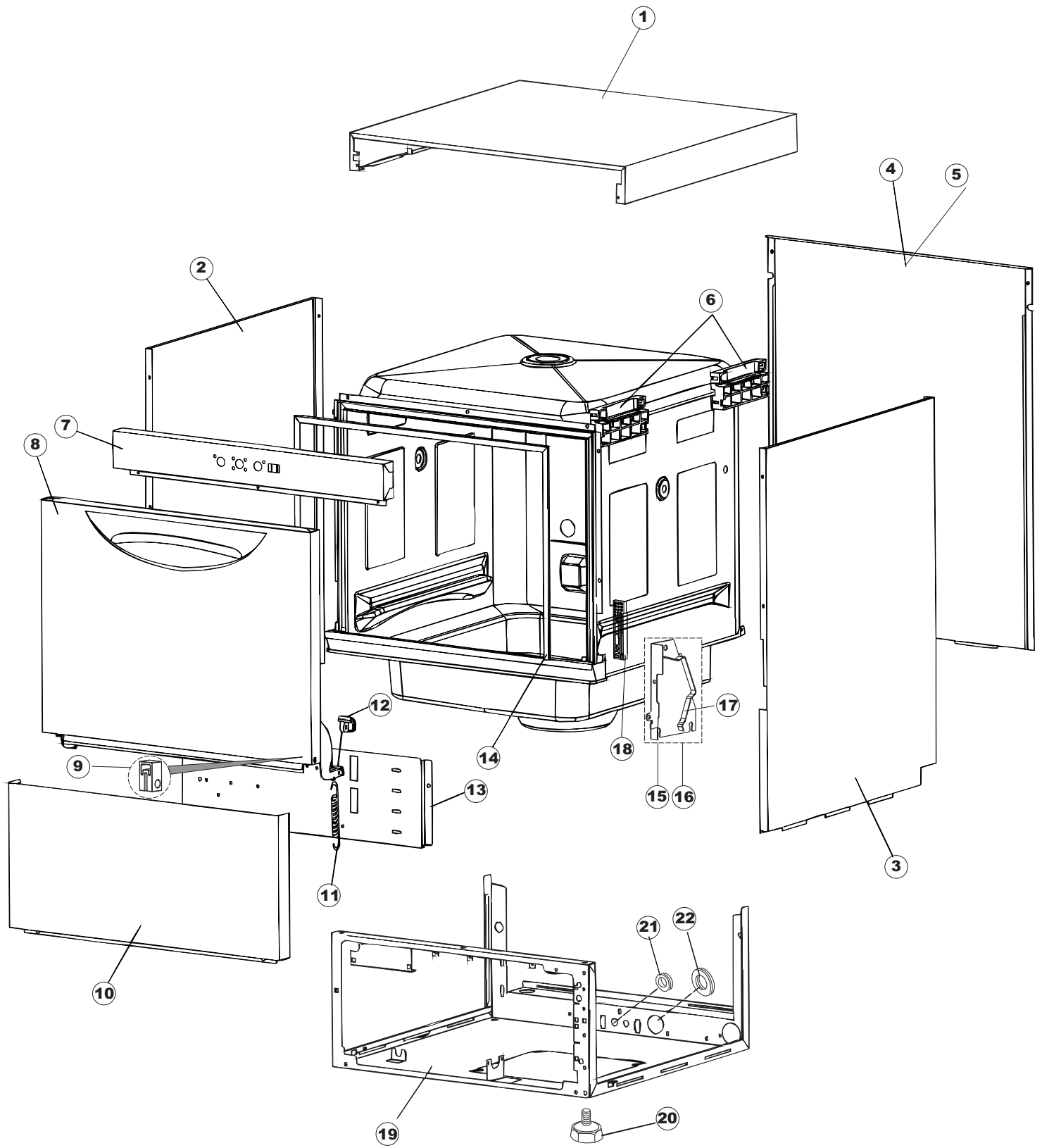

2

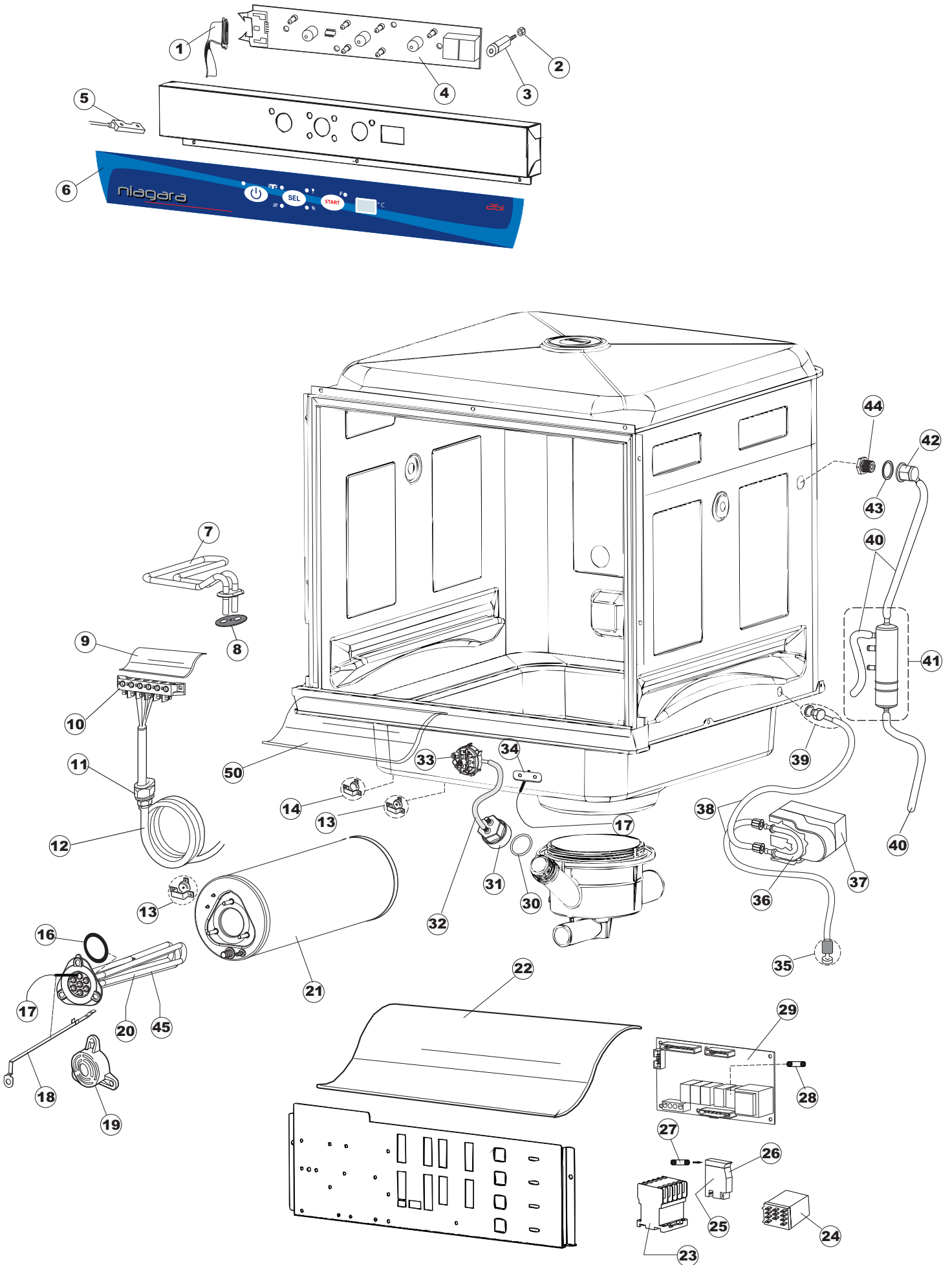

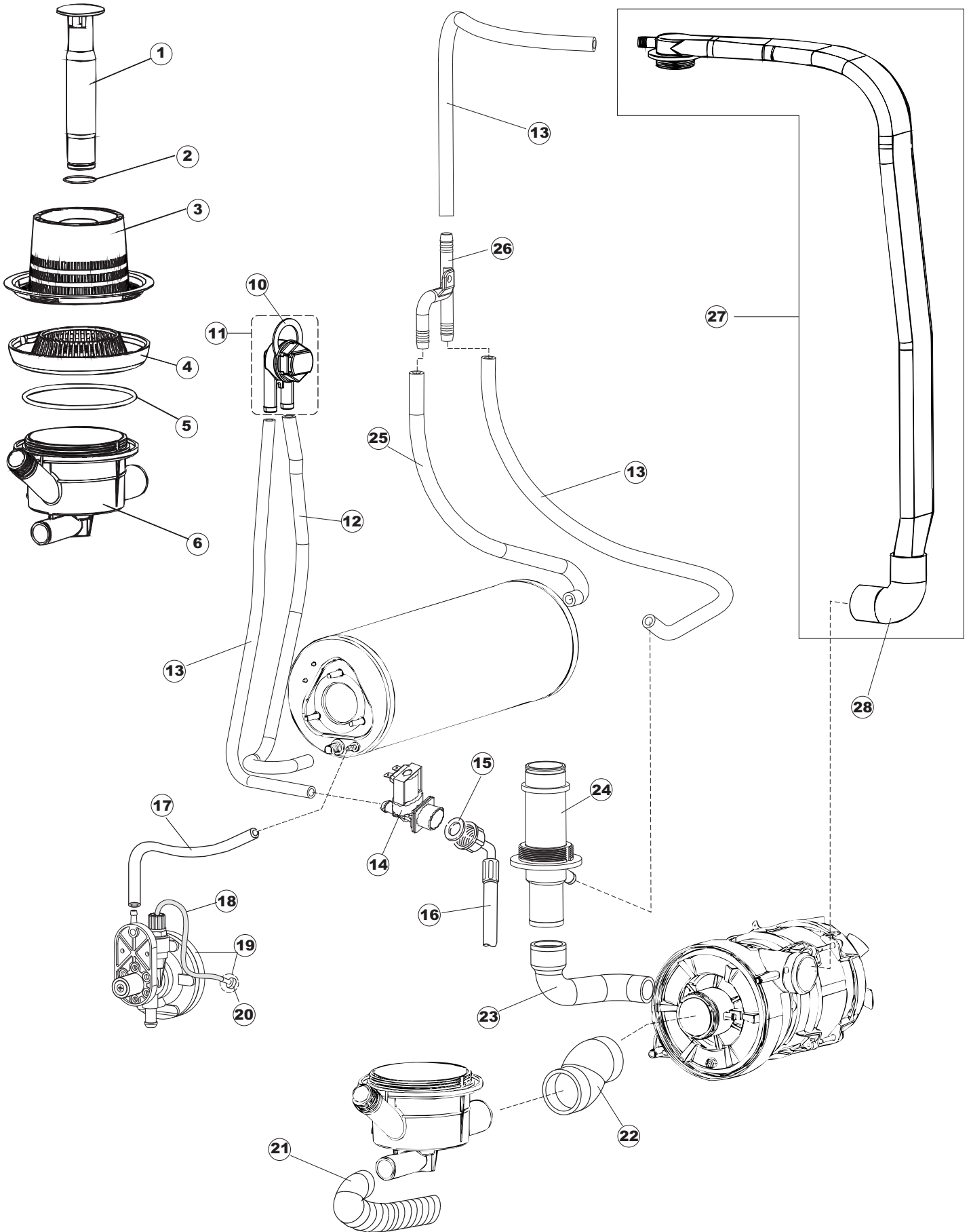

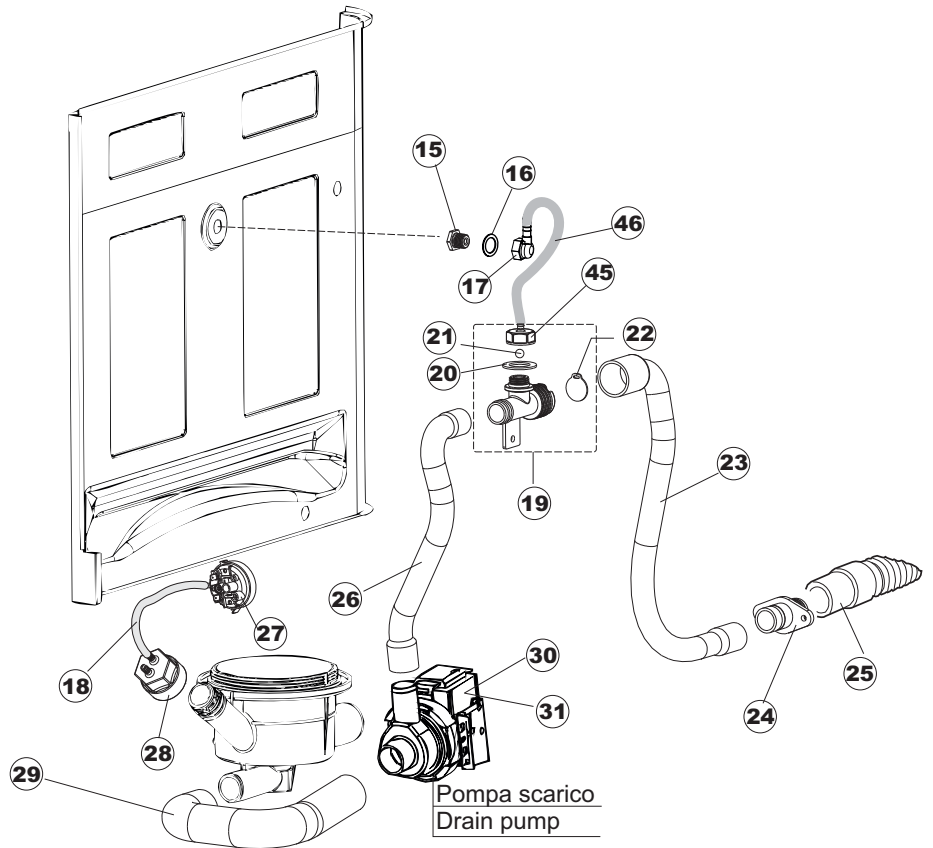
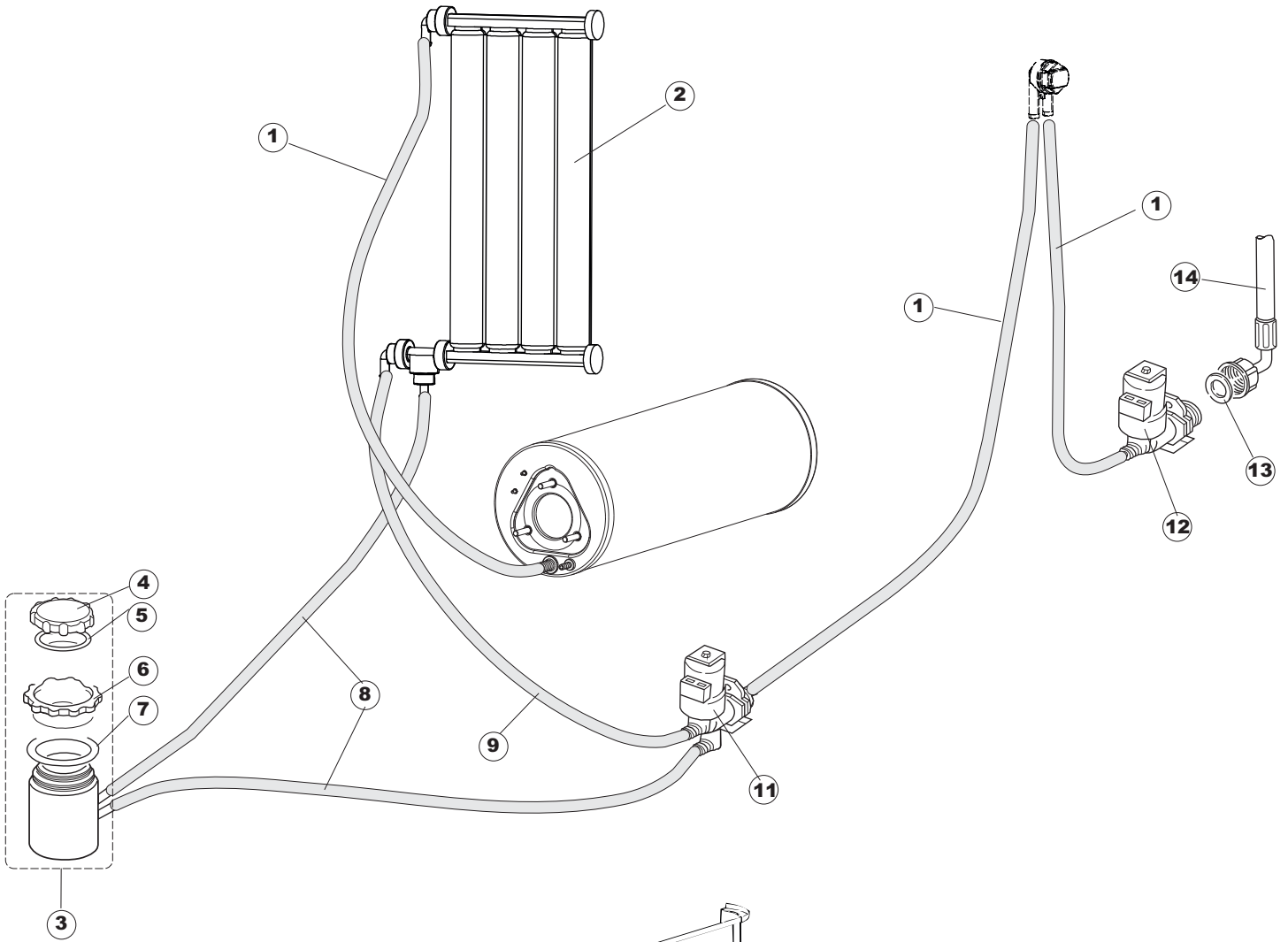

5

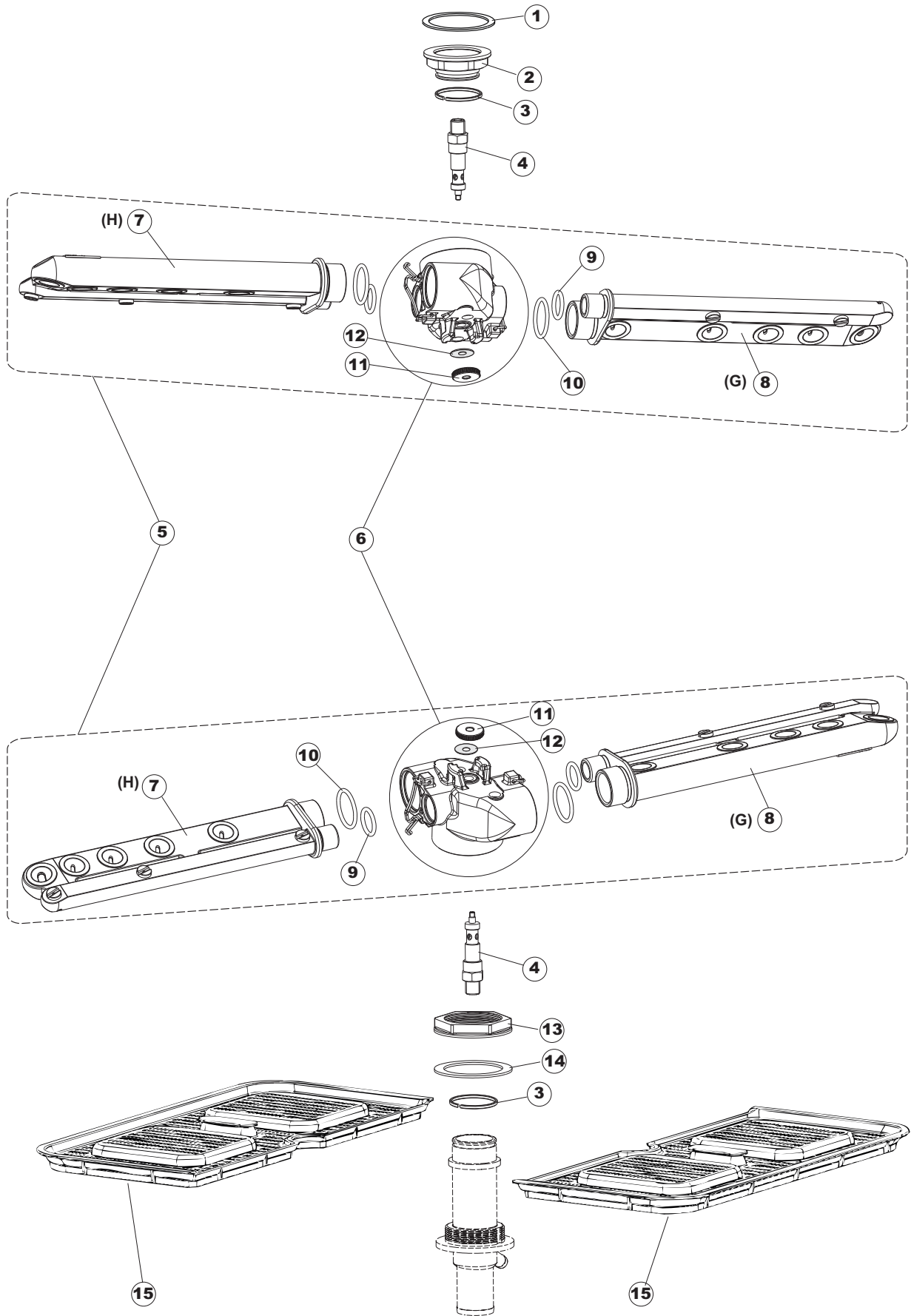

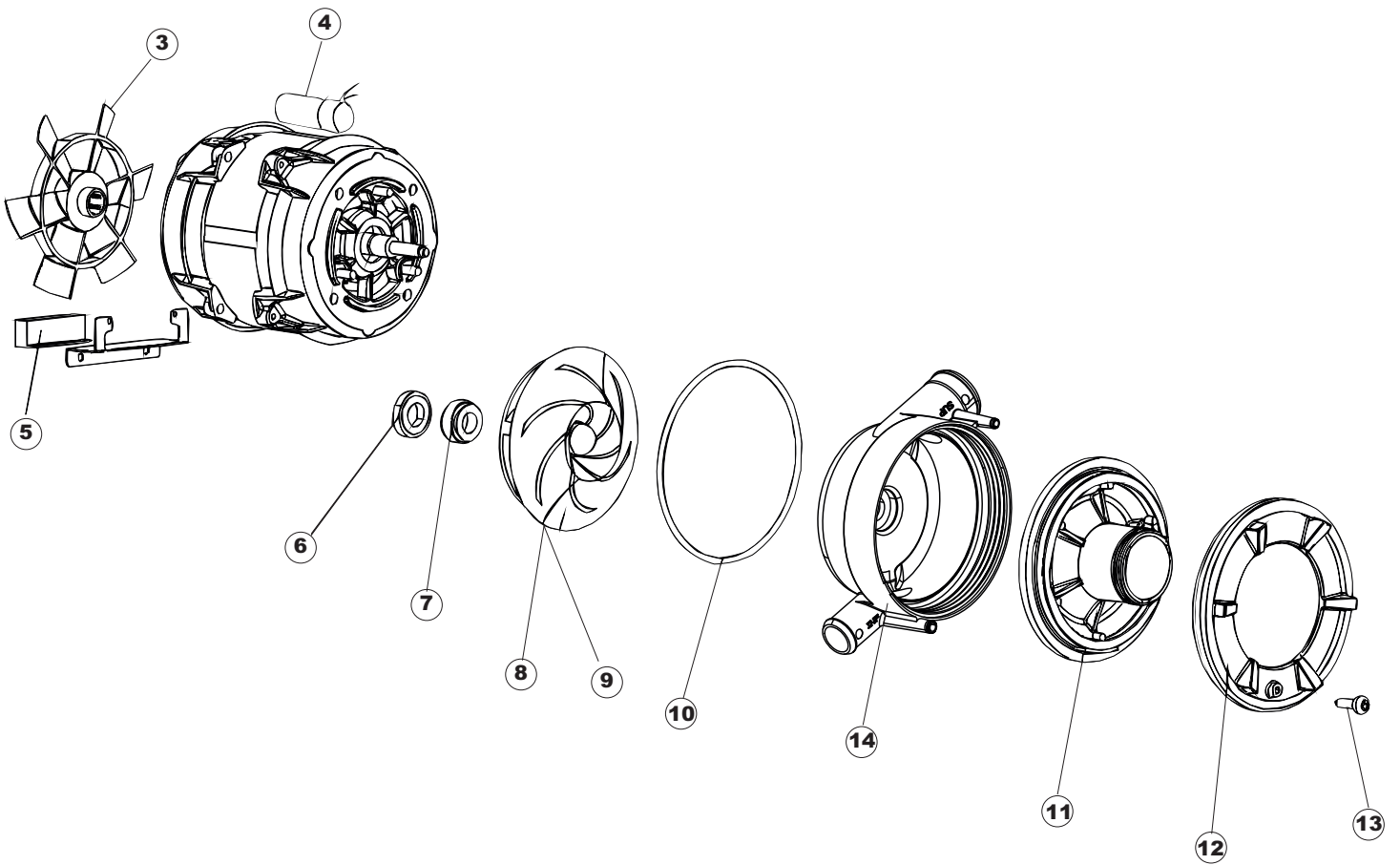
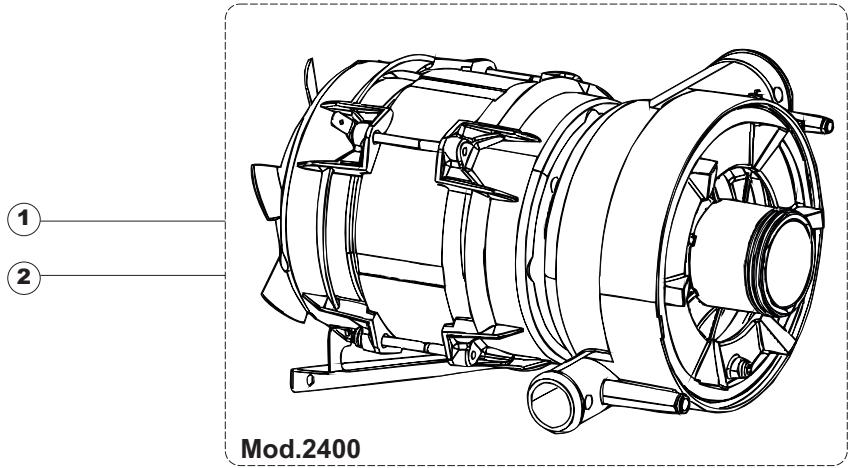

Seite	Position	Code	Alter Code	Beschreibung		
1	1	004175		GEHAEUSEOBERTEIL LA50		
1	2	021116		SEITENWAND LINKS		
1	3	021115		SEITENWAND RECHTS.LA50		
1	4	022146		RUECKWAND LA50		
1	5	022147		RUECKWANDVERKLEIDUNG LA50		
1	6	035083		BUEGEL LA50		
1	7	025837		SCHALTТАFEL LA50		
1	8	029510		TUER KOMPLETT LA50		
1	9	310013		ZENTRIERBLOCK SCHARN-BOLZEN LA50		
1	10	012318		FRONTBLENDE LA50		
1	11	449063		FEDER		
1	12	307014		ANSCHLAG X AUSGL. UND SCHLISSFEDER		
1	13	035081		BEF.WINKEL		
1	14	437103		TUERDICHTUNG		
1	15	999259		GRUPPO STAFFA+MOLLA SAGOM.DX.PORTA LA50		
1	16	999260		GRUPPO STAFFA+MOLLA SAGOM.SX.PORTA LA50		
1	17	449058		FEDER		
1	18	307015		BUEGELLAGER F. TUERSTANGE LA50		
1	19	040119		SOCKEL		
1	20	461019	REB461019	VERSTELLFUSS D30 M8		
1	21	459006	REB459006	KABELDURCHGANG, Di9/De16 22		
1	22	459004	REB459004	ROHRDURCHGANG, GUMMI DI.34		
2	1	211013		FLACHKABEL		
2	2	417119		SCHRAUBENMUTTER, M3 KUNST. WEISS		
2	3	419036		ABSTANDSSTUECK, M3		
2	4	227074		TASTENFELD		
2	5	80871		TUERKONTAKTSCHALTER		
2	6	025898		FRONTBLENDE		
2	7	230112		WIDERSTAND		
2	8	437086	REB437086	DICHTUNG, TANKWIDERSTAND		
2	9	214088		EL.SCHUTZ, TRANSP.KL.3		
2	10	220011	REB220011	* KLEMMENBRETT, 5-POLIG + ERDUNG FV.122		
2	11	459005	REB459005	KABELKLIPPS, STEAB Art.5024		
2	12	H.374339-2		MASCHINE KABERL H07RN-F 5X2.5X3.0MT		
2	13	236047	REB236047	SICHERHEITSTHERMOSTAT		
2	14	236052		THERM.,KONT. BOILER/L.90ø+/-3ø(2611576)		
2	15	236047	REB236047	SICHERHEITSTHERMOSTAT		
2	16	456002	REB456002	O-Ring 48x6,2		
2	17	231016		TEMPERATURSONDE		
2	18	69871		SONDENHALTER		
2	19	69870		HEIZUNGSHUETZ DES WARMWASSERBEREITERS		
2	20	230111		WIDERS.B.4900W/230-400V		
2	21	104060		BOILER		
2	22	214090		EL.SCHUTZ, TRANSP.453		
2	23	229042		SCHALTSCHUETZ		
2	24	229040		RELAIS 62.83.8.230.0300		
2	25	210011		PLAETTCHEN		
2	26	210010		SICHERUNGSHALTER		
2	27	228004		SICHERUNG, 5X20 4A FAST		
2	28	228010		SICHERUNG 5X20 T4A		
2	29	215027		KARTE		
2	30	456073		O-RING		

2	31	107013		LUFT-GLOCKE DES DRUCKSCHALTERS		
2	32	143235		SCHLAUCH 4X7 SILIKON DURCHS. CRP		
2	33	224025		ARBEITSDRUCKWAECHTER 105/125		
2	34	028105		PLATCHEN		
2	35	121993		FILTERANORDNUNG		
2	36	143219	REB143219	MEMBRANSCHLAUCH SANTOPREN		
2	37	209021		DOSIERUNG PERISTALTIK		
2	38	143194	REB143194	SCHLAUCH 4X6 CRISTAL, DURCHS.		
2	39	468151	DZR150NT	TANKEINLAUF CPL NM*		
2	40	H.165178		PVC SCHLAUCH		
2	41	999316		GRUPPO SOFT-START LA50		
2	42	468029	REB468029	VERBINDUNGSSTK. TANKEINLAUF		
2	43	456020	REB456020	O-Ring 3050 R495		
2	44	429076		ENTLÜFTUNGSVENTIL RING		
2	45	230117		HEIZUNG 7600W/400V		
3	1	142058		UEBERLAUFROHR LA50		
3	2	456081		O-RING		
3	3	121120		SIEB		
3	4	429072		ZWINGE		
3	5	456076		TORISCHE DICHTUNG D.I.135.9X5.33		
3	6	136028		ABSAUG-UND ABFLUSSKOERPER LA50		
3	10	437080		DICHTUNG, VERBINDUNGSST., OB.SPÜL.E.40		
3	11	144030		DVGW GERAT (LA500)		
3	12	127091		SAUGMUFFE LA50		
3	13	143004	REB143004	ROHR, DRUCKSCHALTER TP 10X17 (CASER/15NL C4N)		
3	14	240011	REB240011	ZUFLUSSVENTIL 1-WEG C.33290127		
3	15	437041	REB437041	DICHTUNG 3/4 GASVERSORG.		
3	16	929169	RAT32	TUBO DI CARICO DEL TERMOPLAS.VEDI 143270		
3	17	143005	SPG10	SCHLAUCH TP 5X11 (CASER/15/NL C4N)		
3	18	H.775601		ROHR 4x6 CRISTAL BLAU PVC		
3	19	209025		DOSIERPUMPE KLARSPUELER		
3	20	121149		SIEB FUER SPUELMITTELPUMPE		
3	21	143252		ABLAUFLEITUNG		
3	22	127082		NACHSPUEL-FOERDERUNGSBOGEN		
3	23	127085		SAUGMUFFE PUMPE LA50		
3	24	115143		ZENTRALLEITUNG OBEN LA50		
3	25	127090		ZULAUFSCHLAUCH LA50		
3	26	143173	REB143173	VERBIND., NACHSPÜLEN KUNST.35/40/50		
3	27	115140		VEREINTE WASHLEITUNG LA50		
3	28	127084		OBERE DRUCKMUFFE		
4	1	143004	REB143004	ROHR, DRUCKSCHALTER TP 10X17 (CASER/15NL C4N)		
4	2	117007		WASSERENTKAECKER		
4	3	406998	REB406998	SALZBEHALTER NM		
4	4	480005	REB480005	PFRÖPFEN, SALZBEHALTER		
4	5	456052	REB456052	O-Ring 144		
4	6	429011	REB429011	GEWINDERING, SALZBEH.		
4	7	437034	REB437034	DICHTUNG, D68D81S3 GUMMI		
4	8	127098		MUFFE LA50		
4	9	127099		MUFFE LA50		
4	11	999288		GRUPPO VALVOLA DEVIATR.CON RIDUTTORE		
4	12	240016	DEV3S16	ZUFLUSSVENTIL 1-WEG 3/4 230V DROSS.16L		
4	13	437041	REB437041	DICHTUNG 3/4 GASVERSORG.		
4	14	929169	RAT32	TUBO DI CARICO DEL TERMOPLAS.VEDI 143270		
4	15	429075		GEWINDERING		
4	16	437078	REB437078	DICHTUNG, DOSIERER E35/.OB.NACHSPÜLEN		

4	17	468165	REB468165	FITTING, KUNST. VERBINDUNGSST. 35/40/22		
4	18	143235		SCHLAUCH 4X7 SILIKON DURCHS. CRP		
4	19	144991		LUFTLOCH-VENTIL DER ABFLUSSPUMPE LA50		
4	20	437083		DICHTUNG, GUMMI D32D19.5S1.5		
4	21	476008		KUGELHAHN		
4	22	499092		BLENDE		
4	23	127093		MUFFE		
4	24	468152	REB468152	VERBINDUNGSST., ABLAUF CLEAN.3		
4	25	143137	REB143137	ABLASSROHR D18 GEBOG. ENDE		
4	26	127092		MUFFE ABLAUFPUMPE		
4	27	224023		ARBEITSDRUCKWAECHTER 165/140		
4	28	107014		LUFT-GLOCKE DES DRUCKEWAECHTERS LA50		
4	29	127087		MUFFE		
4	30	130177		ABFLUSSPUMPE 50HZ.		
4	31	130181		ABFLUSSPUMPE 60HZ.		
4	45	468205		ABFLUSSANSCHLUSS LA50		
4	46	H.775611-001		ROHR, PVC KRISTALL 10X14		
5	1	437113		DICHTUNG DES KOERPERS -UNTEN- FUER GLAES ERSPUELER		
5	2	429069	REB429069	GEWINDERING, HAUPTLEITUNG X5		
5	3	303037		RING		
5	4	325087		PERNO PETTINE PARALLELI INF.LA50		
5	5	990113		GRUPPO LAV.RISC.BRACCI PARALLELI E50..		
5	6	129068		CORPETTO COMPLETO X PETTINI PAR.D44		
5	7	106153		SPUEL/NACHSPUELARM E50 (8DUESEN) PARALLEL		
5	8	106152		SPUEL/NACHSPUELARM E50 (7 DUESEN) PARALLEL		
5	9	456070		OR D.I.15.54X2.62 ART.20886		
5	10	456071		OR D.I.24X2.5 ART.34916		
5	11	454006		ZAPFEN		
5	12	437100		DICHTUNG		
5	13	429073		MUTTER		
5	14	437102		DICHTUNG		
5	15	121123		INTEGRAL KUNSTSTOFFTANK FILTER		
6	1	130982		WASCHPUMPENKOERPER		
6	2	130981		WASCHPUMPE-KOERPER+ PUMPE		
6	3	335015		LUFERRAD		
6	4	206002	REB206002	KONDENSATOR - 10 mF		
6	5	478062		ELASTISCHBLOCK FUER PUMPE		
6	6	141008		MECHANISCHE DICHTUNG FUER WASCHPUMPE DER GLAESERSPUELER		
6	7	141009		MECHANISCHE DICHTUNG FUER WASCHPUMPE DER GLAESERSPUELER		
6	8	124057		PUMPENFLUEGEL		
6	9	124060		PUMPENFLUEGEL		
6	10	456078		TORISCHE DICHTUNG		
6	11	480148		DECKEL PUMPE		
6	12	429074		RING		
6	13	486242		SCHRAUBE 3.5X13		