

cookmax+



start!

Kühlung Drop-in Element, gekühlte Wanne, Einbau

Artikel-Nr.
90651102 (9DRGR3FIN0A01 / SO-GREEN3)

Explosionszeichnung / Ersatzteile

Bitte bei Ersatzteilbestellung immer Artikelnummer und Seriennummer mit angeben!

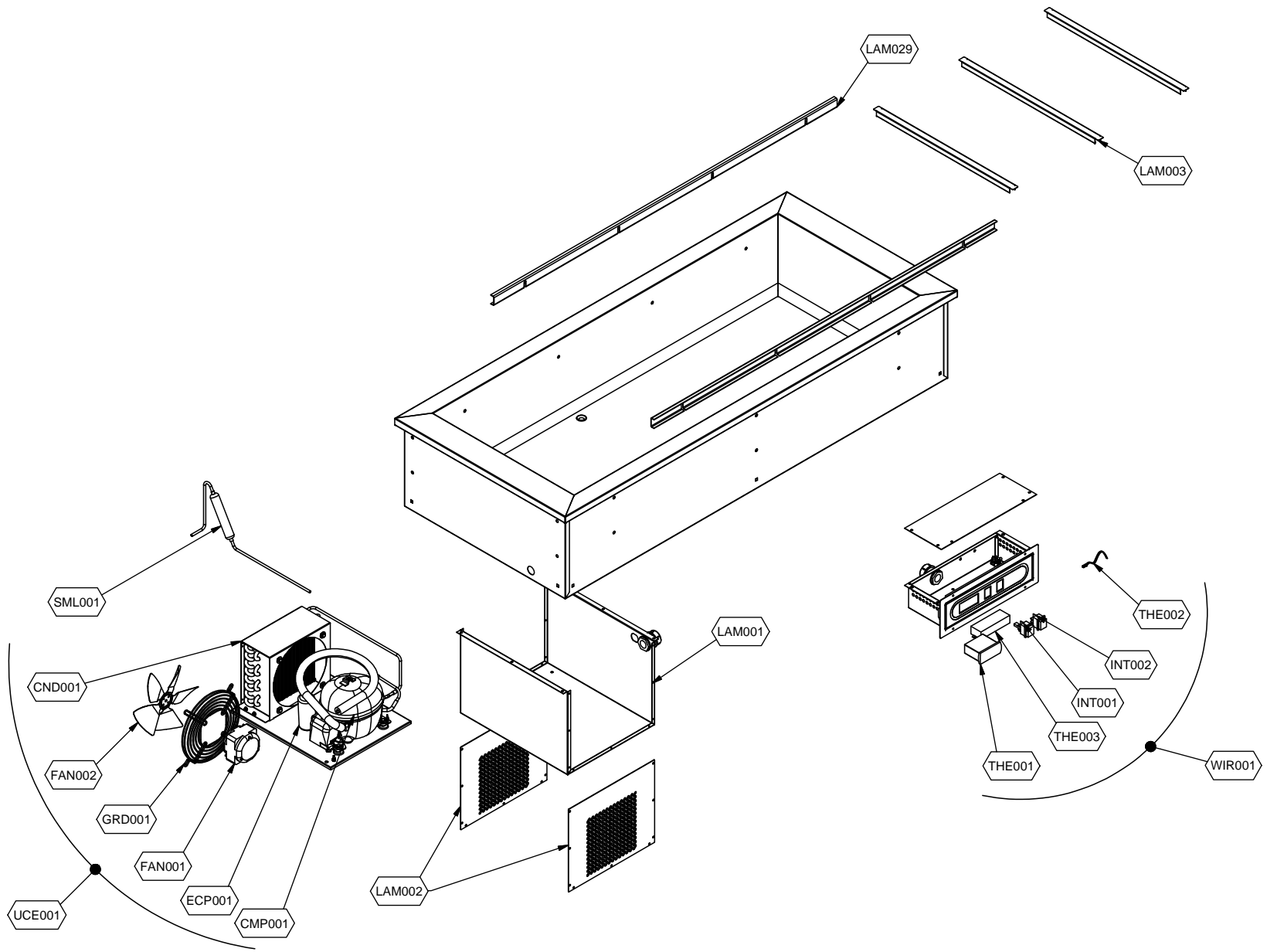

Il presente disegno non può essere riprodotto, utilizzato o comunicato a terzi.

Exploded View

Validity: 08/04/2016

9DRGR3FIN0A01	SOUL GREEN 3I VASCA REF.STAT SENZA SOV.
ESP001-01	SOUL GREEN INCORPORATO

Ref. Drawing	Code	Description
CMP001	74865722	COMPR. EMT6152GK CSIR 230V/50HZ R404A
CND001	74837032	CONDENS. 8TX3R 230*210*110 FIJI 4/1
ECP001	74867008	PARTI ELETTR.COMPR.EMT6152GK CSIR
FAN001	74848151	VENT.10W 230V L=1500 FISSAGGIO GRIGLIA E
FAN002	74848156	PALA.ASP.DIAM.200\34°
GRD001	74845144	GRIGLIA FE.A CESTELLO PER PALA 200-34°
INT001	74742008	INT.NERO ON-OFF 16A SH JS-608FA-O-B-6
INT002	74742017	INTERR.ARANC.LAMP 16A B418C1H1X0000 MOLV
LAM001	72539511	LAM.SUPP.UCE ZINC.
LAM002	72539513	GRIGLIA AERAZIONE ZINC.POST.DROP-IN
LAM003	72556044	LAM.SUPP.VASCH.GRBF 151 530*20
LAM029	72539482	LAM.SUPPORTO VASCHETTE 3/1 DROP-IN
SCE001	SC850	SCHEMA ELETTRICO DROP-IN REFRIG.
SML001	73670236	ASS.FILTRO UCE FIJI QUADRO 4-1
TAR001	RIF.TAR.B01	PARAMETRI DROPIN & BUFFET GREEN
THE001	74700881	CENTR.PYAO1C0522-BZ 230V H/C
THE002	74700916	SONDA NTC IKE 3METRI -50/+105°
THE003	74700892	ALIMENTATORE LAMPADA LED MW LPHC18-350MA
UCE001	74861322	UCE EMT6152GK R404A DROP-IN 3-4/1
WIR001	73669900	ASS.Q.E REF.STAT.DROP-IN