

537017000 (400V3N 230V3 230V)
537022700 (400V3)
537025800 (440V3)

544191100 (74)
544191200 (78)
544191300 (712)

537019900 (400V3N 230V3 230V)
537022600 (400V3)
537025700 (440V3)

544190800 (74)
544190900 (78)
544191000 (712)

536014700 (X)

539018900

536034400

537000300

537035400 (X)

539060200

539054200

537014100

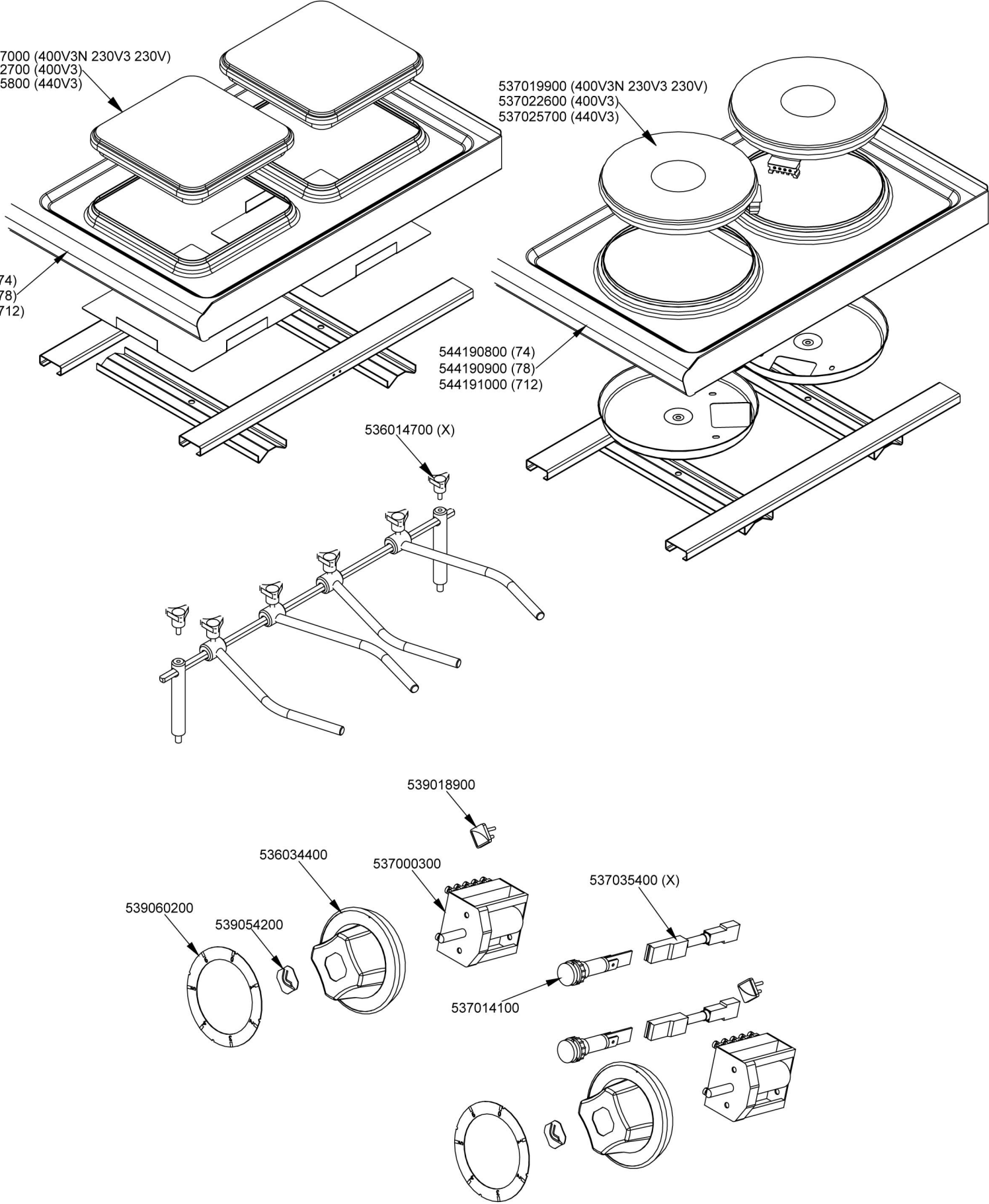

Page	Pos	Code	Description
001		537002100	ELECTRICAL PLATE D.145 W1000 V230
001		537019800	ELECTRICAL PLATE D.180 W2000 V230
001		541210000	UPPER PLATE FOR PCT-6 3E
001		544508100	LHD SIDE OF 60T APPLIANCES
001		537027400	TERMINAL BLOCK THREEPHASE 40A
001		541191100	CONTROL PANEL 607090 PCT-63E
001		544508000	RHD SIDE OF 60T APPLIANCES
001		533010500	LEG M10*25 D.40
002		537017000	PLATE 220X220 W2600 V230
002		537022700	ELECTRICAL PLATE 220X220 W2600 V400
002		537025800	PLATE 220X220 W2600 V440
002		537019900	PLATE D.220 W2600 V230
002		537022600	ELECTRICAL PLATE D.220 W2600 V400
002		537025700	ELECTRICAL PLATE D.220 W2600 V440
002		544191100	UPPER PLATE PC-74E SQUARE PLATE
002		544191200	UPPER PLATE PC-78E SQUARE PLATE
002		544191300	UPPER PLATE PC-712E SQUARE PLATE
002		544190800	UPPER PLATE PC-74E ROUND PLATE
002		544190900	UPPER PLATE PC-78E ROUND PLATE
002		544191000	UPPER PLATE PC-712E ROUND PLATE
002		536014700	3 DRILL WHEELS
002		539060200	RED ADESIVE DISK FOR PC-E
002		539054200	STAMP Ø20,5 CR."L" LOTUS R.
002		536034400	KNOB §77 4P. §06*4,6 C/M
002		537000300	COMMUTATOR 7 POSITIONS S.49 16A
002		539018900	INDEX FOR KNOB W/RED SIGN
002		537035400	HEATING ELEMENT 00003W 330KOHM W/F
002		537014100	WHITE WARNING LIGHT 250V