

CARAT

TECHNICAL MANUAL



TM_EN

Part No.: I764016_02

Date: I31105

EXOBAR®

CONTENT	2
SYMBOL DESCRIPTION	4
Hazard intensity levels	4
GENERAL	5
Carat 1GR	5
Accessories.....	5
Carat 2GR	6
Accessories.....	6
OVERVIEW OF COMPONENTS.....	7
Carat 1 group.....	7
Carat 2 groups.....	8
INSTALLATION	9
Positioning.....	9
Electrical installation.....	9
Connection types.....	9
PROGRAMMING	10
Electronic control panel	10
Button functions.....	10
Additional capabilities reachable from the display	11
Programming the coffee dosage	12
Programming of hot water volume.....	12
Programming temperature for the turbo steamer	12
Maximum security time	13
Access to second level menus	13
Clock adjustment, hour, minutes and day	13
Auto on/off.....	14
Counters	15
Counters access	15
Counter Litres	15
Service:Warning to technical maintenance.....	16
Total espressos	16
Partial counter	17
Brewed services per keypad counter	17
Access to the technical programming.....	17
Select language.....	18
Colour option.....	18
Mode setting	18
Colour setting.....	19
Display mode.....	19
Contrast.....	20
Colour ON.....	20
Colour OFF	20
Name 1:Adjust the publicity message on the display (superior line).....	21
Name 2:Adjust the publicity message on the display (inferior line).....	21
Service pone.....	21
Dosed service enabling.....	22
Continuous brewing button	22
Electronic steam wand.....	22

Pre-brewing	23
Adjusting the pre-brewing parameters	23
Probe sensitivity	23
Grinding notice.....	24
Adjusting parameters of the grinding notice	24
Grinding notice.....	24
Chronometer.....	25
Maintenance cycle.....	25
Temperatures: °C or F	25
Boiler temperature	26
Multi boiler setting.....	26
Groups temperature	26
Offset temperature set.....	27
PID parameters	27
Water softener filter: Regeneration	27
MESSAGES AND ALARMS.....	28
TROUBLESHOOTING.....	29
ELECTRICAL DIAGRAM.....	30
Display board and IO-Board outputs 2Gr 230V.....	30
Display board and IO-Board outputs 2Gr 400V.....	31
Display board and IO-Board outputs 2Gr Multi Boiler 400V.....	32
Display board and IO-Board outputs 1Gr 230V.....	33
WATER SYSTEM.....	34
Machine with 1GR	34
Machine with 2GR	35
EXPLODED VIEW.....	36
Machine with 1GR	36
Machine with 2GR	38
Rotary pump	40
Boiler 1GR.....	42
Boiler 2GR.....	44
Heat exchanger	46
Turbo steamer	48
Steam wand	50
Hot water outlet.....	52
Group head	54
Lower water system.....	56
Porta-filter	58
Machine components	59

Hazard intensity levels

There are three different levels of hazard intensity, identified by signal words **DANGER**, **WARNING** and **IMPORTANT**. The level of hazard is determined by the following definitions.

Observe the statements to ensure safety, performance, prevent injury and machine damage.



Important:

Alerts against unsafe practices. Observe to ensure drink quality, machine performance, food safety, to prevent minor personal injury or damage to the machine.



WARNING!

Indicates a potentially hazardous situation which, if not avoided, could result in scalding, serious injury and even death.



DANGER!

INDICATES A IMMINENTLY HAZARDOUS SITUATION WHICH, IF NOT AVOIDED, WILL RESULT IN SERIOUS INJURY AND EVEN DEATH.



Note:



Gives additional information which may be helpful during the cleaning procedure or operation of the machine.

Carat IGR

FACTS	CARAT MINI I GROUP		
	Standard	Standard (Turbo Steamer)	Touch Button (Turbo Steamer)
Steam wand	2pcs	1pc	1pc
Hot water outlet	1pc	1pc	1pc
Turbo steamer	None	1pc	1pc
Electronic temperature control	Yes		
Stand by mode	Yes		
Height, width, depth	620, 586, 563mm		
Boiler volume	6L		
Power supply	230V AC 50/60Hz 1F+N 2750W		
Cold water connection	3/8" Internal thread		

MODEL/NAME	WEIGHT
Carat IGR standard	45kg
Carat IGR turbo steamer	45kg
Carat IGR turbo steamer with touch buttons	45kg

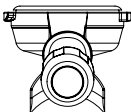
Accessories

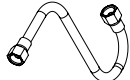
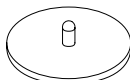
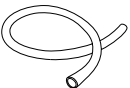
MODEL	2-spout porta-filter	1-spout porta-filter	55-cm inlet hose	Cleaning membrane	Drainage tube (150 mm)
					
MINI IGR	1 unit	1 unit	1 unit	1 unit	1 unit

Carat 2GR

FACTS	CARAT 2 GROUPS		
	Standard	Standard (Turbo Steamer)	Touch Button (Turbo Steamer)
Steam wand	2pcs	1pc	1pc
Hot water outlet	1pc	1pc	1pc
Turbo steamer	None	1pc	1pc
Electronic temperature control	Yes		
Stand by mode	Yes		
Height, width, depth	620, 774, 563mm		
Boiler volume	1.1L		
Power supply	Single-phase 230V AC 50/60Hz 1F+N 3250W Multi-phase 380V AC 50/60Hz 3F+N 4750W		
Cold water connection	3/8" Internal thread		

MODEL/NAME	WEIGHT
Carat 2GR standard	63kg
Carat 2GR turbo steamer	63kg
Carat 2GR turbo steamer with touch buttons	63kg

Accessories

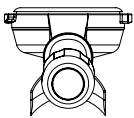
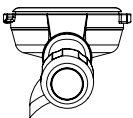
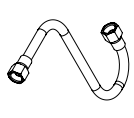
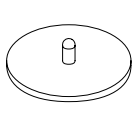
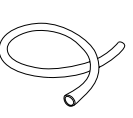
MODEL	2-spout porta-filter	1-spout porta-filter	55-cm inlet hose	Cleaning membrane	Drainage tube (150 mm)
					
MINI 2GR	2 unit	1 unit	1 unit	1 unit	1 unit

Front view of the machine

Carat I group

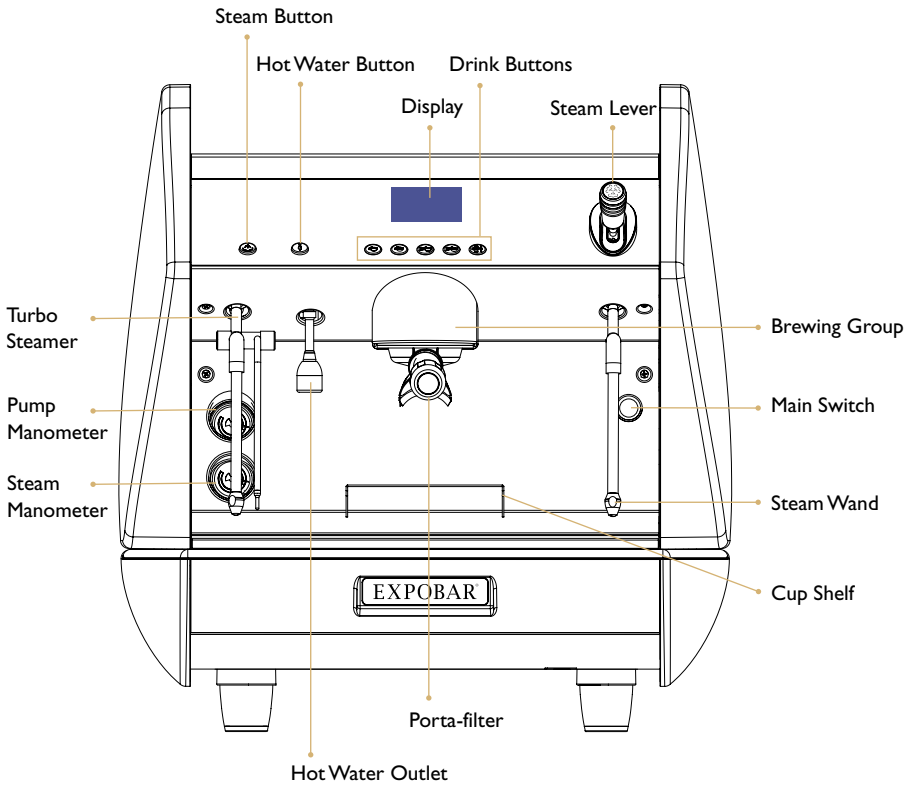

Front view of the machine

Carat 2 groups

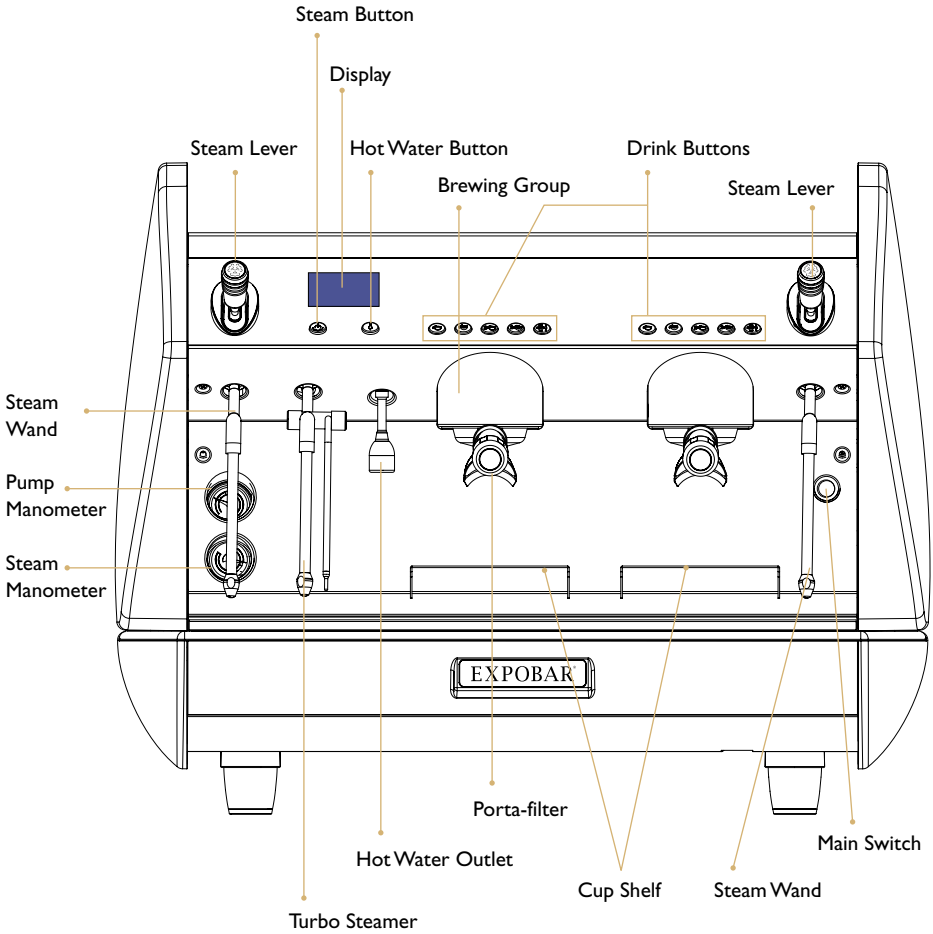

Positioning

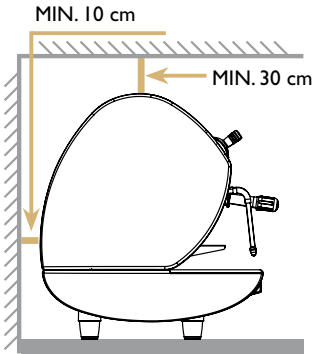

- Install the machine on a level surface. Adjust the feet to ensure that it dispenses coffee evenly in all of the cups.
- Select a level, dry, strong and stable installation surface at least 110 cm off the floor.
- Leave enough space above and behind the machine to ensure easy cleaning and maintenance.
- Do not install the machine whilst wet or damp. If wet or damp, leave the machine until completely dry then ask service personnel to check that none of the electrical components are affected.



Note:

Leave an air gap of approximately 30 cm above the machine and 10 cm behind it to ensure ventilation.

Electrical installation

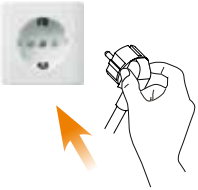

The coffee machine should only be connected to the power supply by qualified personnel. The following safety instructions should be followed at all times:

- Check that the electrical specifications on the ratings plate match the specifications of the power supply at the point of installation.
- The coffee machine must be connected to an earthed socket that complies with the regulations in force in the country of installation.
- You should protect the electric line of the installation with a circuit breaker switch appropriated for the power consumption of the machine, specified on its ratings plate.
- A residual current circuit breaker must be installed in accordance with the characteristics of the area of the installation.
- Check the characteristics, power rating of the system and that the diameter of the cables are suitable for the power used by the machine.
- Do not connect the coffee machine to the power supply via extension boards, adapters or shared sockets.

The manufacturer will not be held liable for damage to persons, animals or property resulting from incorrect installation of the coffee machine.



DANGER!

If the mains cable or plug is damaged, it must be replaced by the manufacturer, its service agent or similarly qualified persons in order to avoid **SERIOUS INJURY OR DEATH!**

Connection types

- Connect the machine as per the instructions on the ratings plate.

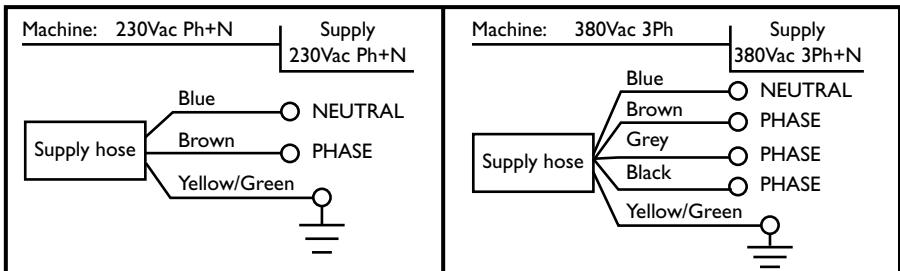

Electronic control panel

Button functions

Here some of the additional functions that the electronics offers:

- Volume control of four different espresso drinks per brewing group.
- Time-controlled hot water dispensing.
- Automatic filling and level control of the boiler.
- Automatic switch off of the heating element if not enough water.
- System supervision through alarms.
- Automatic cleaning of the brew groups

The control panel is by default programmed with 4 standard drinks (these can be reprogrammed as you wish) and a continuous selection. The first four keys (1 short espresso, 1 long espresso, 2 short espresso, 2 long espresso) brew the programmed volume and then stop automatically, the fifth key brews continuously until user stops it by pressing button again.

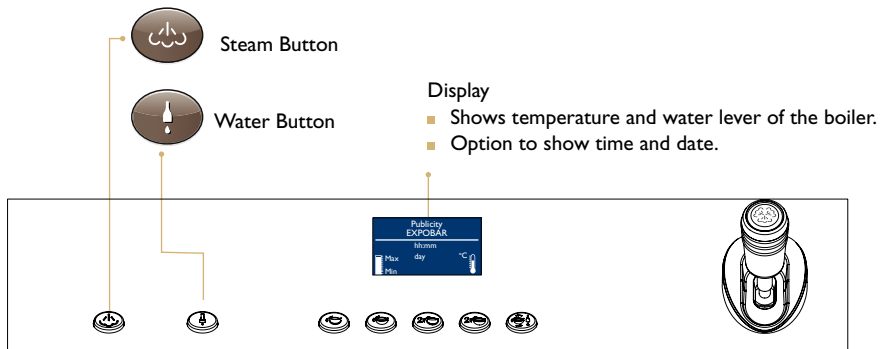

1 Short Espresso



2 Short Espresso



1 Long Espresso



2 Long Espresso



Continuous

Depending on how long this button is pressed it has 3 functions:

- Less than 1 second, activates the hot water for infusions dosing.
- Between 1 and 8 seconds, activates continuous espresso dispensing, in order to stop the dispensing, press the button again.
- Over 8 seconds, activates the programming menu. This is explained later in programming part.

Additional capabilities reachable from the display

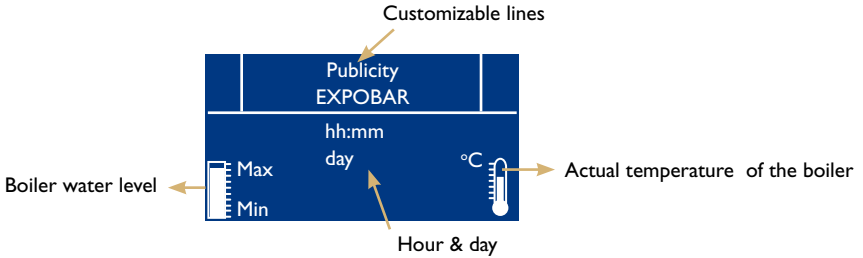

- Automatic switch ON/OFF; “Stand by” function.
- Time management: Current day and time.
- Advertising display.
- Total counter of erogated espressos and hot water services (through the display).
- Digital control and visualization of the temperature in the boiler.
- Maximum control of temperature in the boiler through PID technology.
- On-display help for reprogramming and adjusting.
- Visual alarm about the need of replacing water softener filter.
- Display language selection.

(OFF+ON)
Service reset
(espresso)

Group boiler OFF / ON :
Continuous + I long espresso:
(multi-boiler machines)

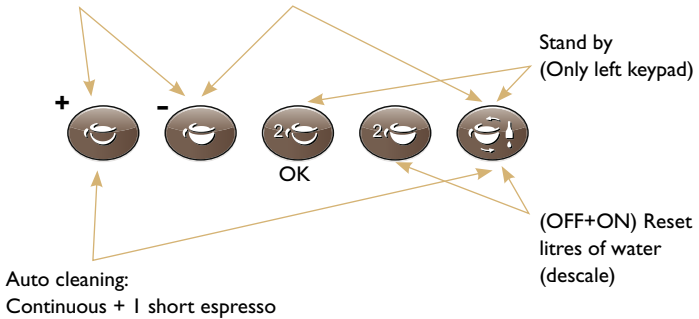

Programming the coffee dosage

This section explains how to program the doses dispensed automatically by the drink buttons.

- Keep the continuous button  pressed over 8 seconds, all the lights in the keypad will light up and continuous button will flash.
- Within 30 seconds press any selection that you want to reprogram (1 short espresso, 1 long espresso, 2 short espresso, 2 long espresso). Notice that all the lights will turn off except the selection you made and the continuous button.
- The group begins to dispense espresso, when the desired volume of espresso is reached, press the selection button that is light up to stop dispensing, this volume will now be stored as default.
- Repeat this process with all the selections that needs to be reprogrammed.

In case you only want to reprogram one of the selections, acts as previously described and only reprogram one selection. The other selections will keep the existing settings.



Important:



Use a porta-filter filled with fresh coffee for every new dose you program.





Note:

Programming any of the options on the left-hand Drink buttons (when viewing the machine from the front) automatically sets the dispensing volumes on all of the other Drink buttons. This only applies to the left-hand Drink buttons. Programming other Drink buttons only modifies the option selected.

Programming of hot water volume

- Keep the continuous button  pressed over 8 seconds, all the lights in the keypad will light up and continuous button will flash.
- Press the continuous button  for less than 1 second. Water will dispense from the hot water wand.
- Press the same button  again to stop the dispensing and store the new volume. Different water volumes can be stored in each keypad.

Programming temperature for the turbo steamer

- Keep the continuous button  pressed over 8 seconds, all the lights in the keypad will light up and continuous button will flash.
- Immerse the steam wand in the liquid to be heated up.
- Press the steam button .
- When the liquid reaches the desired temperature, press steam button  again to stop. The new temperature is now stored.

When programming this button it will only affect the temperature of the liquid, not the time steaming. Once the electronic steam wand with temperature probe reaches the programmed temperature it will automatically turn off. Different volumes of liquid will not affect the temperature.

Maximum security time

As an additional safety, all dose settings have a maximum dispensing time of 5 minutes.

Access to second level menus

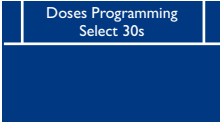

fig.A

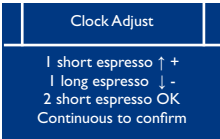







fig.B

- Keep the continuous button  pressed over 8 seconds on the left keypad.
- (Entering first level, See fig.A). Now all the lights in the keypad will light up and continuous button will flash. Do not release the continuous button  until the display shows “Clock adjust”(See fig. B). From this point we are in the second level menu.
- Enter “Clock adjust” by pressing the button  (2 short espresso) or browse through the system with button  (1 short espresso) or  (1 long espresso).

Clock adjustment, hour, minutes and day

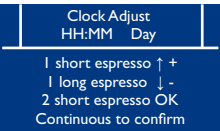













fig.C

- To adjust the clock press the button  (2 short espresso) while “Clock adjust” is displayed.(See fig. C)
- The hour starts to flash, increase or decrease its value by pressing the button  (1 short espresso) or  (1 long espresso).
When the rightvalue is reached, accept it by pressing the button  (2 short espresso).
- Now the minutes starts to flash, increase or decrease its value by pressing the button  (1 short espresso) or  (1 long espresso).
When the right value is reached, accept it by pressing the button  (2 short espresso).Then the day of the week can be adjusted in the same way ( ,  & ).
- When all values have been adjusted and is confirmed with button  (2 short espresso) the display will proceed to the next menu.

Auto on/off

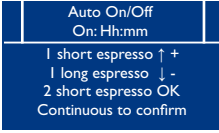

Fig. A

- After accepting the adjusting made in the time and day by pressing the button (2 short espresso), we enter in the programming of the automatic ON/OFF function of the machine.(See fig.A)
- To modify the time which the machine automatically gets into the “ON” status, while the hour is flashing, increase or decrease its value by pressing the button (1 short espresso) or (1 long espresso). When the right value is reached, accept it by pressing (2 short espresso).Then the minutes will start to flash and will be adjustable in the same way (, &).



Note:

By default, this first value will be: On: - : - - this means that the function is disabled.As soon as we modify the value, and it become different from - : - - the function will be enabled. If we prefer to leave this function disabled, just accept by pressing the button (2 short espresso) while the adjusted value is - : - - .

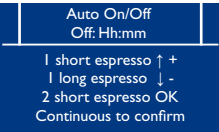

Fig. B

- Now the automatically OFF time is flashing, increase or decrease its value by pressing the button (1 short espresso) or (1 long espresso).When the right value is reached, accept it by pressing the button (2 short espresso).Then the minutes will blink, and will be adjustable in the same way(, &).With this final confirmation, display will proceed to the next menu.(See fig. B)
- If automatic ON and OFF times have been assigned, a day off can be enabled in which the machine will not switch on at all.The day off menu will not appear if the automatic ON/OFF times is not set.(See fig. C)

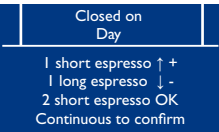

Fig. C

- To adjust the day OFF, increase or decrease its value by pressing the button (1 short espresso) or (1 long espresso) . When the right value is reached, accept it by pressing the button (2 short espresso).



Note:

By default, this first value will be: On: - : - - this means that the function is disabled.As soon as we modify the value, and it become different from - : - - the function will be enabled. If we prefer to leave this function disabled, just accept by pressing the button (2 short espresso) while the adjusted value is - : - - .

Counters

There are 4 counters available:

- Litres: litres of water which have come through the machine (help to know when decalcifying is needed)
- Service: coffee brewings needed for technical service.
- Total coffee & hot water brewings
- Coffee brewings per dose keypad

Counters access

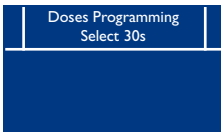

A

- Keep the continuous button  pressed over 8 seconds, all the lights in the keypad will light up and continuous button will flash.
The display will show:(See fig.A)

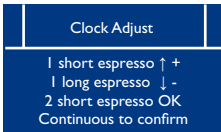

B

- Once again, press, and maintain pressed the continuous button  till the display shows "Clock adjust". (See fig.B)

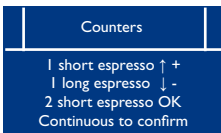

C

- Press briefly the continuous button , the display will show the option "Counters". (See fig.C)

Counter Litres

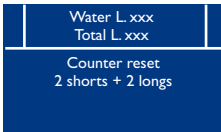

D



This counter shows the volume of water (litres), that has been through the machine. Its main purpose is to facilitate the control of when a regeneration of the water softener is needed.

How to access:When the display shows "counters", accept by pressing  (two short espressos).

To exit and get to the next menu, press the continuous button .

- In chapter 10.31 Water softener filter: Regeneration, it can be programmed how many litres of water the machine will use before giving the warning of the need to regenerate the water softener. This way, the counter counts the litres of water and warns the user when it is needed to do the regeneration of the water softener.

To reset this counter (reset litres counter):

- The espresso machine must be in the ON Status.
- Turn off the machine using the main switch.
- Maintain pressed both button  (2 short espresso) and  (2 long espresso), and while pressing them, turn on the espresso machine from the main switch.
- Press the continuous button  to confirm the reset.

Service: Warning to technical maintenance

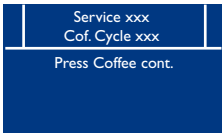



Fig.A



This counter shows on the first row (See fig.A), the number of services set for the machine to request for technical service and maintenance. On the second row it is shown the number of services brewed (individual brewed services) made by the machine since the last reset.

How to access: From the counter “Litres” get to this counter by pressing the continuous button .

To get out and get to the next menu, press the continuous button .

It can be programmed the number of brewed services before the electronics give the warning to make the technical maintenance.

To reset the counter (reset the service counter):

- The espresso machine must be in the ON status.
- Turn off the machine using the main switch.
- Keep pressed both buttons  (1 short espresso) and  (1 long espresso), and while pressing them, turn on the espresso machine from the main switch.
- Press continuous button  to confirm the reset.

Total espressos

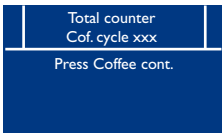



Fig. B

This totalizer adds up all the services brewed by the machine. (See fig.B) Therefore, it cannot be reset.

How to access:

- From the counter “Service”, access to this counter pressing the continuous button .
- To exit and proceed to the next menu, press the continuous button .

Partial counter

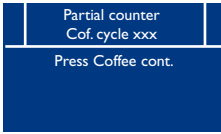

This counter constitutes a partial counter since last reset.(See fig.A)

Fig.A

Brewed services per keypad counter

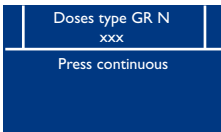





Fig. B

- This counter shows the number of brewed services brewed by each of the possible selections of the machine. (See fig.B)
- On the superior side of the display it is shown the dosis type (Espresso, long espresso, 2 espressos, 2 long espressos, continuous or hot water). On the right side it is shown which of the groups is now displayed. Underneath it is shown the amount.
- These counters can be reset as follow: While displays shows as fig.A, press at the same time both buttons  (2 short espresso) and  (2 long espresso) for more than 4 seconds.

Access to the technical programming



- OFF + >14s → Technical prog.
- Next Menu

- The access to these adjustment menus is only possible from the left keyboard of the machine (left, facing the machine).
- With the machine in the stand by (OFF) state, keep pressed the continuous button  for more than 15 seconds till the display shows the following message: "Language: English" or "Lengua: Español".

Select language

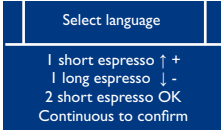







Fig.A

- When on the display it is shown: “Select Language” and the selected language(See fig.A), we can change the language used in the display.

To change the current language used, press one short espresso  (+) or one long espresso  (-).

- Spanish - German - Italian - French - English

← (-)  (one long espresso) → (+)  (one short espresso)

- To accept the selection made and proceed to the next menu, press the continuous button .

Colour option

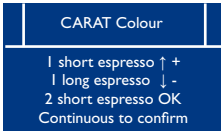



Fig. B

To accept the selection made and proceed to the next menu, press the continuous button  . (See fig.B)

Mode setting

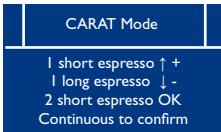





Fig. C

To accept the selection made and proceed to the next menu, press the continuous button  . (See fig.C)



Colour setting



Fig.A

- When on the display it is shown "Bar Led Colour"(See fig.A), the colour of the led lines on the base of the machine can be adjusted.To toggle between the different options use the one short espresso  (+) or one long espresso  (-) buttons.The effect of the option selected can be observed directly on the machine.

Off, red, green, blue, purple, light green, light blue, white.

← (-)  (one long espresso) → (+)  (one short espresso)







- To accept the selection made and proceed to the next menu, press the continuous button .
- In this menu (See fig.B), we adjust the behavior of the led lines on the base of the machine.To toggle the mode use the one short espresso  (+) or one large coffee  (-) buttons.The leds will respond immediately to the option selected.



Fig. B

Scrolling - Christmas – off – Fix on – blinking – dynamic -

← (-)  (one long espresso) → (+)  (one short espresso)

- To accept the selection made and proceed to the next menu, press the continuous button .

Display mode

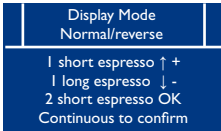





Fig. C

- The display has two working modes:"Normal" in which the letters are light against a dark background, or "Reverse" or negative, in which the letter are shaped by not lighting their shape in the background (See fig.C) .
- To toggle between the two modes, use the one short espresso  (+) or one long espresso  (-) buttons.The effect can be seen directly on the display.
- To accept the selection made and proceed to the next menu, press the continuous button .

Contrast

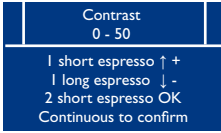





Fig.A

- In this menu(See fig.A), the contrast of the display lightning is set. It can be adjusted between the values of 0 and 50. To adjust it use the one short espresso  (+) or one long espresso  (-).

The effect can be seen directly on the display.

- To accept the selection made and proceed to the next menu, press the continuous button .

Colour ON

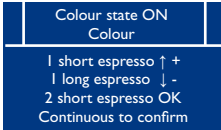

Fig. B



- Here, the colour of the display while in "ON" state is set(See fig.B). This means that it can be different when the machine is in the "OFF" status.

To toggle between the different options use the one short espresso

 (+) or one long espresso  (-).The effect of the option

selected can be observed directly on the machine.

- Spanish - German - Italian - French - English

← (-)  (one long espresso) → (+)  (one short espresso)

- To accept the selection made and proceed to the next menu, press the continuous button .

Colour OFF

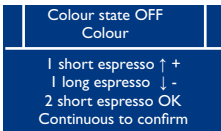



Fig. C

- Now, the colour of the display while in "OFF" state is set(See fig.C).To toggle between the different options use the one short espresso

 (+) or one long espresso  (-).The effect of the option

selected can be observed directly on the machine.

- Spanish - German - Italian - French - English

← (-)  (one long espresso) → (+)  (one short espresso)

- To accept the selection made and proceed to the next menu, press the continuous button .

Name 1: Adjust the publicity message on the display (superior line)

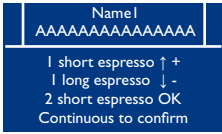





Fig. A

The message shown (See fig.A) on the 2 superior lines of the display can be adjusted here and in the following menus.

Here the first row will be adjusted.

- To modify the selected letter for the blinking character press the one short espresso  (+) or one long espresso  (-).
- To accept the selected character and proceed to the next one, press the button  (2 short espresso).

To accept the line and proceed to the next menu, press the continuous brewing button.

Name 2: Adjust the publicity message on the display (inferior line)

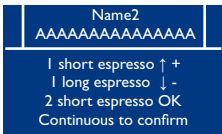





Fig. B

In this menu (See fig.B) the second row of the customizable lines is set.

- To modify the selected letter for the blinking character press the one short espresso  (+) or one long espresso  (-).
- To accept the selected character and proceed to the next one, press the button  (2 short espresso).



To accept the line and proceed to the next menu, press the continuous brewing button.

Service phone



Fig. C

In this menu (See fig.C), it is set the telephone number shown when the warning caused by reaching the number of services set for technical maintenance.

- To modify the selected number for the blinking character press the one short espresso  (+) or one long espresso  (-).
- To accept the selected character and proceed to the next one, press the button  (2 short espresso).

To accept the line and proceed to the next menu, press the continuous brewing button.



Dosed service enabling

Doses setting Enabled/disabled
1 short espresso ↑ + 1 long espresso ↓ - 2 short espresso OK Continuous to confirm

Fig.A

This menu Enables/disables(See fig.A) the possibility of modifying the doses volumes set.This is, makes it possible to disable (they will not work) the possibility for the user to modify the doses set in the machine.

This option prevents the final user from dis-adjusting the doses set of the machine.

- To enable modifying the setting, press the button  (one short espresso), to disable, press the button  (one long espresso).
- To accept the setting and proceed to the next menu, press the continuous button .



Continuous brewing button

Continuous key Option
1 short espresso ↑ + 1 long espresso ↓ - 2 short espresso OK Continuous to confirm

Fig. B

This menu (See fig.B) toggles the behavior of the continuous brewing button into different working modes.

The options are: # Tea + continuous. # Only coffee cont. # Only Tea



- To modify the selected mode press the button  (one short espresso) or .
- To accept the setting and proceed to the next menu, press the continuous button .

Electronic steam wand

Steam Boiler Gr. N
1 short espresso ↑ + 1 long espresso ↓ - 2 short espresso OK Continuous to confirm

Fig. C

In this menu, (See fig.C) it is set which keypad is phisically connected (internally) to the button of the electronic steam wand. By factory default this is set to 1, and it should not be modified, as malfunctioning of the machine would occur.



- Increase of decrease the value by pressing the button  (one short espresso) or .
- To accept the setting and proceed to the next menu, press the continuous button .

Pre-brewing

Pre-brewing Enabled/disabled
1 short espresso ↑ + 1 long espresso ↓ - 2 short espresso OK Continuous to confirm

Fig. A

This setting enables or disables the electronic pre-brewing (See fig.A). By factory default this option is disabled, as the Brilliance's brewing groups are equipped with mechanical pre-brewing systems.





- To activate this function press the button  (one short espresso), to disable, press the button  (one long espresso).
- To accept the setting and proceed to the next menu, press the continuous button .

Adjusting the pre-brewing parameters

Pre-brew. ON sec Selection type X.Xs
1 short espresso ↑ + 1 long espresso ↓ - 2 short espresso OK Continuous to confirm

Fig. B

If in the previous menu the pre-brewing function was enabled, this menu will appear as to allow the adjusting of the parameters of the pre-brewing. As said, this machine is already equipped with mechanical pre-brewing, so it is not to activate this function.

- On this first menu, it is adjusted the pre-brewing time for each type of selection (short espresso, large coffee, 2 short espressos & 2 large espressos). in which water is pumped as to moisture the grinded coffee.
- To adjust it press the button  (one short espresso) or  (one long espresso).
- To accept the setting and proceed to the next menu, press the continuous button .
- Now it is adjusted the pre-brewing time for the little pause after the initial water injection, as to allow the grinded coffee to moisture depending on each type of selection.
- To accept the setting and proceed to the next menu, press the continuous button .

Pre-brew. OFF sec Selection type X.Xs
1 short espresso ↑ + 1 long espresso ↓ - 2 short espresso OK Continuous to confirm



Fig. C

Probe sensitivity

Probe Sensitivity Low/Mid/High
1 short espresso ↑ + 1 long espresso ↓ - 2 short espresso OK Continuous to confirm

Fig. D

Here it can be adjusted the detection sensibility of the level probes of the boiler. (See fig.D) Normally it is not needed to modify it from the "medium", but in some cases (very pure water, this is water with very low level of dissolved salts), it will be needed to select High sensibility and vice versa. By default this sensibility will be set to "Med", and generally it is not needed to modify it.

- To increase sensibility, press the button  (one short espresso), to decrease it, press the button .
- To accept the setting and proceed to the next menu, press the continuous button .

Grinding notice

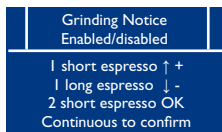





Fig. A

This setting enables or disables the brewing monitor (See fig.A). This function analyzes the output flow when brewing, and depending on it, advises if the grinded coffee is too thin or too coarse. If the brewing flowrate was between limits, it will display "Ok" at the end of the brewing process.

- To enable it, press the button , to disable it, press the button .
- To accept the setting and proceed to the next menu, press the continuous button .

Adjusting parameters of the grinding notice

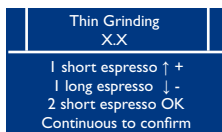





Fig. B

If in the previous section the grinding notice was enabled, in this menu, its parameters can be adjusted. If it was disabled, this menu will not appear.

Here it is adjusted the minimum flow rate that will be considered as inferior limit of a good brewing flowrate.

- To increase this value, press the button , to decrease it, press the button .
- To accept the setting and proceed to the next menu, press the continuous button .

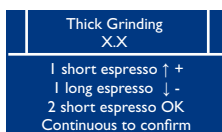





Fig. C

Here it is adjusted the maximum flow rate that will be considered as superior limit of a good brewing flowrate.

- To increase this value, press the button , to decrease it, press the button .
- To accept the setting and proceed to the next menu, press the continuous button .

Grinding notice

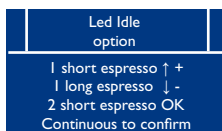





Fig. D



- The blinking of the keypads lights have different behavior modes that can be toggled by pressing the button  (one short espresso) and  (one long espresso).
- The options are: Enabled, disabled & Rotation leds.
- To accept the setting and proceed to the next menu, press the continuous button .

Chronometer

Crono option
1 short espresso ↑ + 1 long espresso ↓ - 2 short espresso OK Continuous to confirm

Fig.A

The displays (See fig.A) of each group have different working modes:



- Brewing chronometer: When brewing an espresso, the display acts as a chronometer measuring the time taken to erogate the espresso.
- Pulses: The group display, graphically shows the espresso brewing speed during the espresso erogation by displaying the flowmeter pulses.
- Disabled: Easch group display is not affected when brewing espresso.
- To change between the different option use press the button  (one short espresso) or  (one long espresso).
- To accept the setting and proceed to the next menu, press the continuous button .

Maintenance cycle

Maintenance cycle XXXX
1 short espresso ↑ + 1 long espresso ↓ - 2 short espresso OK Continuous to confirm

Fig. B



Here it is adjusted the Number of espresso brewings needed for maintenance cycle, (shower screen replacing, gaskets, etc.) When the service counter reaches the number set here, on the display it is shown the warning “Service needed”, and the Phone of the service.

- To increase this value, press the button  (one short espresso), to decrease it, press the button .
- To accept the setting and proceed to the next menu, press the continuous button .

Temperatures: °C or F

Temperature °C/°F
1 short espresso ↑ + 1 long espresso ↓ - 2 short espresso OK Continuous to confirm

Fig. C

- To show the temperature in °F (Fahrenheit) press the button  (one short espresso),
- To show the temperature in °C (Celsius) press the button  (one long espresso).
- To accept the setting and proceed to the next menu, press the continuous button .

Boiler temperature

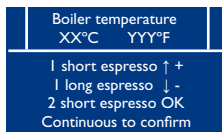





Fig.A

In this section the temperature of the boiler is set.

- To increase temperature, press the button  (one short espresso), to decrease it, press the button  (one long espresso).
- To accept the setting and proceed to the next menu, press the continuous button .

Multi boiler setting

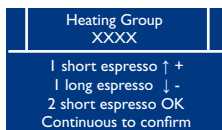





Fig. B

Here is set the actual number of extra boilers that the machine has. This setting is factory set, and must not be modified, as this would cause a malfunctioning.

- To modify the setting press the button  (one short espresso), or  (one long espresso). The options are:
 - GR1+GR2 (One main boiler and 2 groups boilers)
 - OFF (Only one main boiler machine)
- To accept the setting and proceed to the next menu, press the continuous button .

Groups temperature

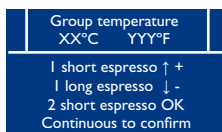





Fig. C

Here it is adjusted the temperature for each group and the main boiler. If the previous menu was set to "OFF", only the temperature for the main boiler will appear in this menus.

- To increase temperature value, press the button  (one short espresso), to decrease it, press the button  (one long espresso).

Group temperature1 – Group temperature2 – Main boiler temperature
- Once adjusted each temperature, press the continuous button  as to adjust the next group/boiler temperature.
- Once set the temperature of the last group/boiler, when pressing the continuous button  it will proceed to the next menu.

Offset temperature set

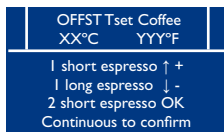

Fig.A

In this setting it is set the temperature offset to be considered between the group boiler and the group head. If the Grupos Calefactados (multicaldera) was set to “OFF”, this menu will not appear.

This parameter is factory set to 10°C, and it is recommended not to modify it.

- To increase temperature drop, press the button (one short espresso), to decrease it, press the button (one long espresso).
- To accept the setting and proceed to the next menu, press the continuous button .

PID parameters

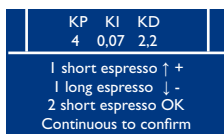

Fig. B

In this menu the PID internal parameters are set. This parameters are factory set and they must not be modified, as doing so will cause the machine to malfunction. By default they are: kP=4, kI=0,07, kD=2,2.

- To adjust each parameter, press the button (one short espresso) and (one long espresso).
- Once adjusted each parameter, press the continuous button to proceed to the next parameter. When having adjusted the last one, when pressing the continuous button, the next menu will appear.

Water softener filter: Regeneration

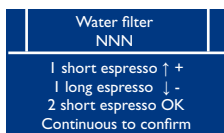



Fig. C

Here it is adjusted the liters of water after which the electronics will warn about the need of regenerating the water softener.

- To increase this number, press the button (one short espresso), to decrease it, press the button (one long espresso).
- In Contador Litros chapter it is shown the volume of water already used by the machine since last reset.
- To accept the setting and proceed to the next menu, press the continuous button .

Model of water softener	Quantity of water treated depending on water hardness (water hardness units: french degrees)					Salt KG
	20°	30°	40°	60°	80°	
L 8	1200	1000	900	700	500	1
L 12	1900	1500	1350	1050	750	1.5

Approximated litres of water treated until regeneration of the water softener is needed.

<p>Alarm flowmeter X</p> 	<p>Flowmeter X failure / No flow detected in flowmeter X</p>
---	--

<p>No water</p> 	<p>Check that the machine is receiving water.</p>
--	---

<p>Tprobe Unconnect X</p> 	<p>Temperature sensor X fault.</p>
--	------------------------------------

<p>Service 9999999</p> 	<p>Warning technical service needed.</p>
--	--

<p>Filter 999999999</p> 	<p>The water softener filter needs to be replaced.</p>
--	--

The following checks can be carried out by users once the machine has been turned off and disconnected from the power supply. For all other non-specified machine faults, disconnect the machine from the power supply and immediately contact authorised and qualified service personnel.

Problem	Possible cause	Solution
The machine does not start up	The plug is not correctly inserted into the power socket	Check that the plug is correctly inserted and that the power socket is operational.
	The circuit breaker and/or differential are disconnected.	Check that they are connected.
	The cable and/or plug are damaged.	Call service personnel to replace them.
The steam wand does not dispense steam	The steam wand is clogged by milk	Clean the wand and, if necessary, remove the nozzle and unclog it using a pin or needle.
Water is found underneath the machine	The drainage tube is blocked.	Clean the drainage tube.

Faults produced by limescale

Coffee not dispensed at right temperature:	Heat-exchanger outlet pipes clogged by limescale.
Brewing groups do not dispense water:	Water system is clogged by limescale.
90% of faults are due to limescaling inside the coffee machine (due to not softening the water). To avoid these faults, maintain the water softener regularly.	

Coffee-grinding problems

Coffee dispensing is very fast:	The coffee grinding is too coarse. Adjust the coffee-grinding setting.
Coffee dispensing is very slow:	The coffee grinding is too fine. Adjust the coffee-grinding setting.

Display board and IO-Board outputs 2Gr 230V

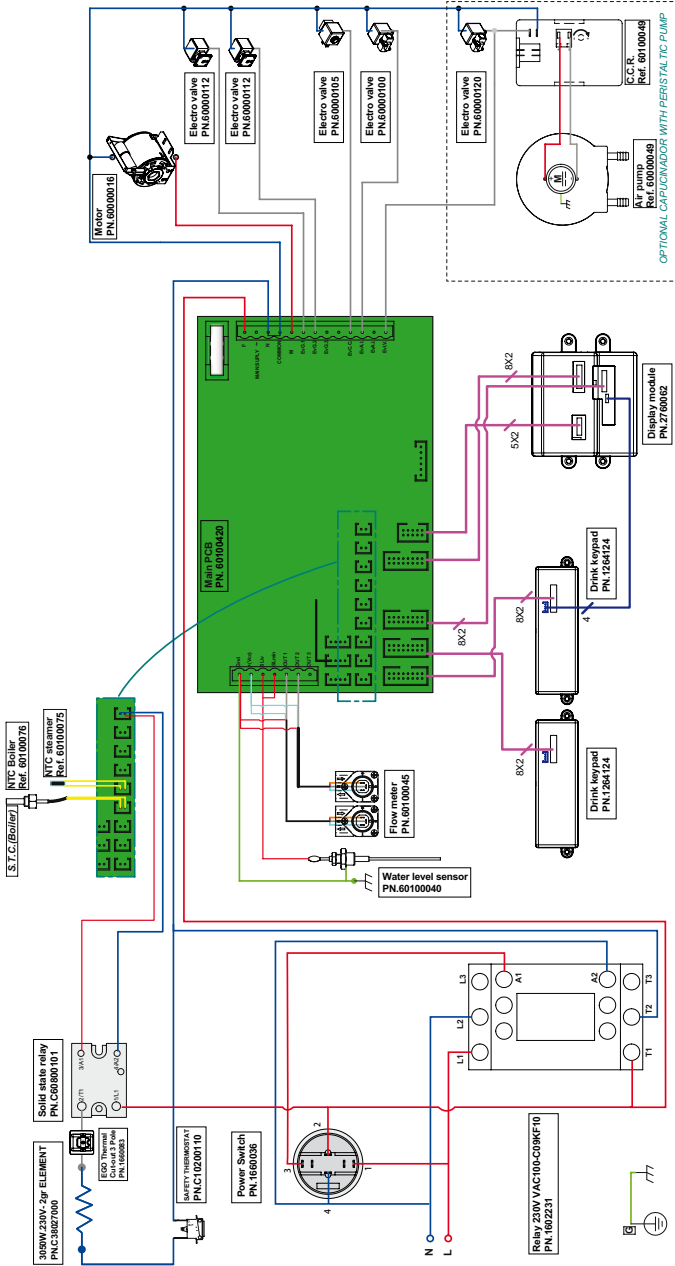

Display board and IO-Board outputs 2Gr 400V

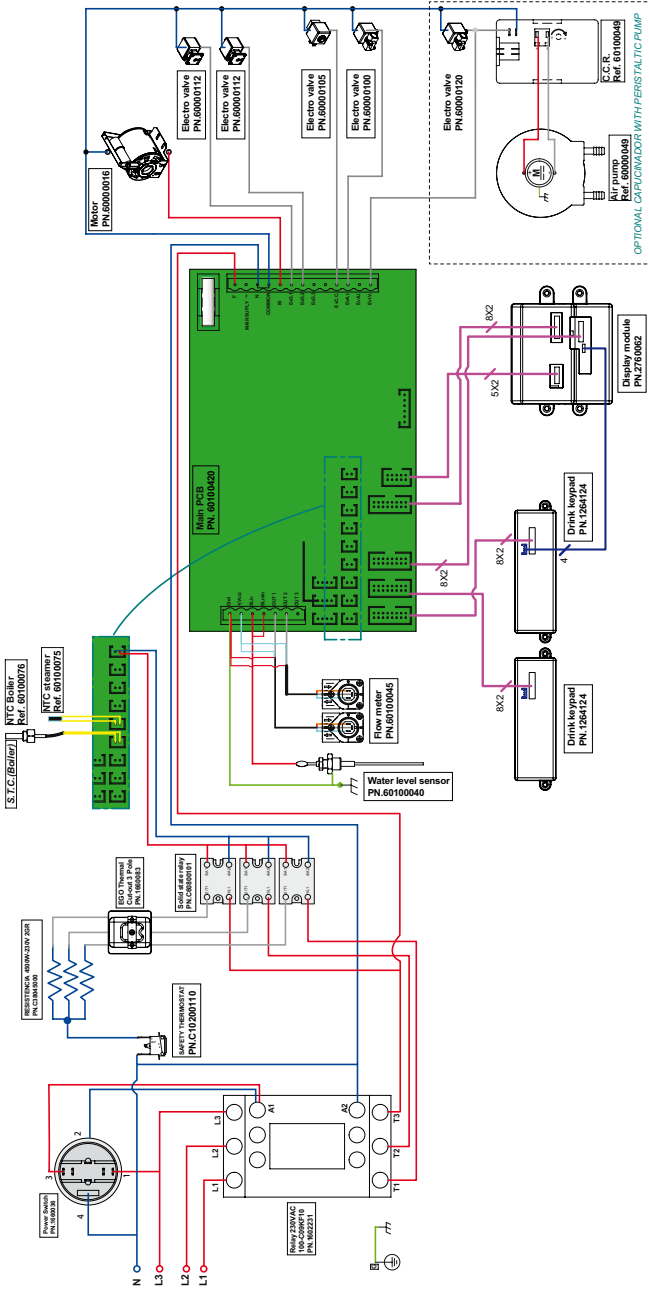

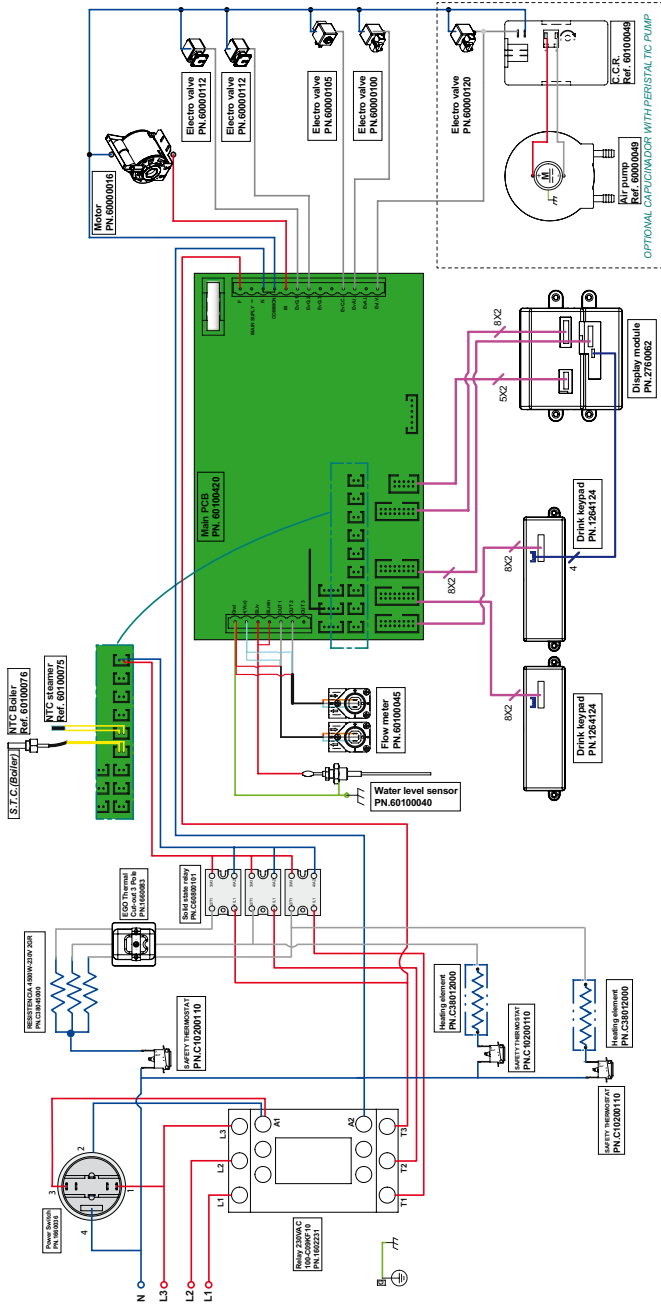

Display board and IO-Board outputs 2Gr Multi Boiler 400V

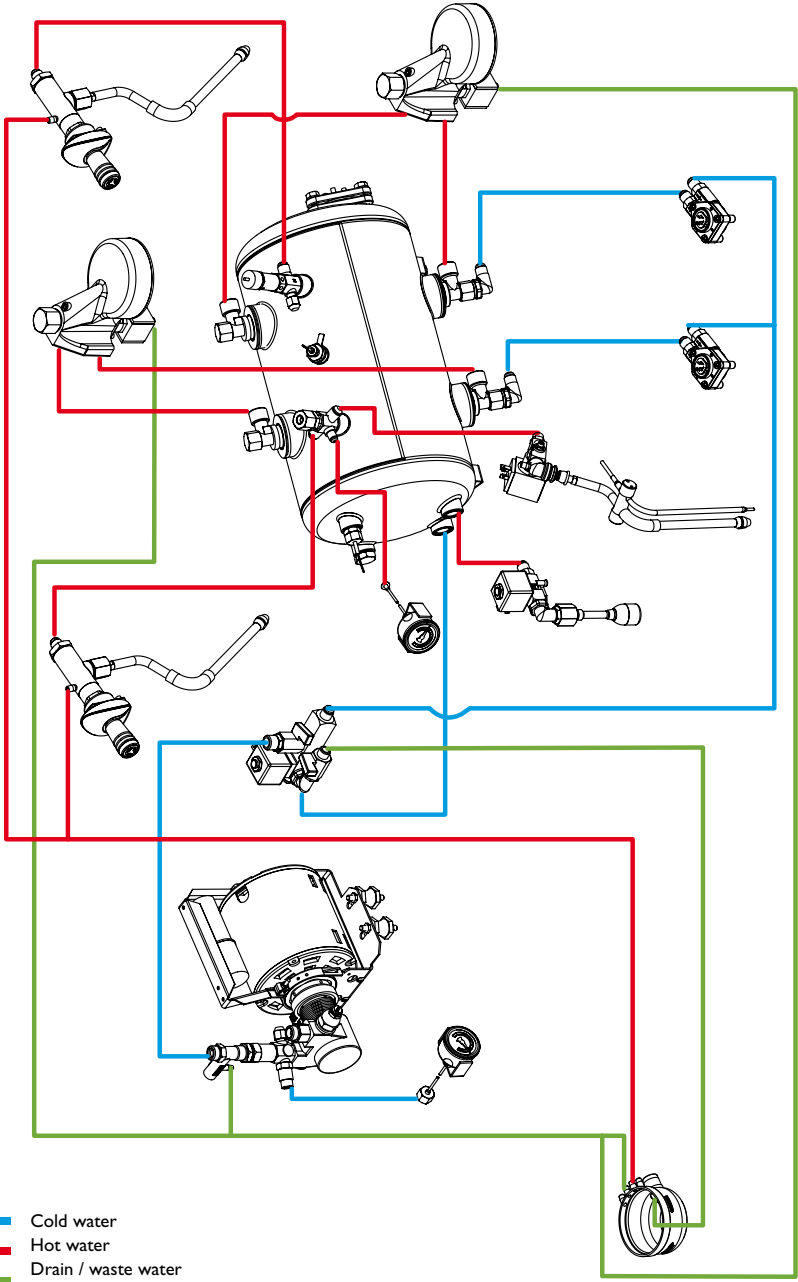

Machine with 2GR



-  Cold water
-  Hot water
-  Drain / waste water

Machine with IGR

Drawing

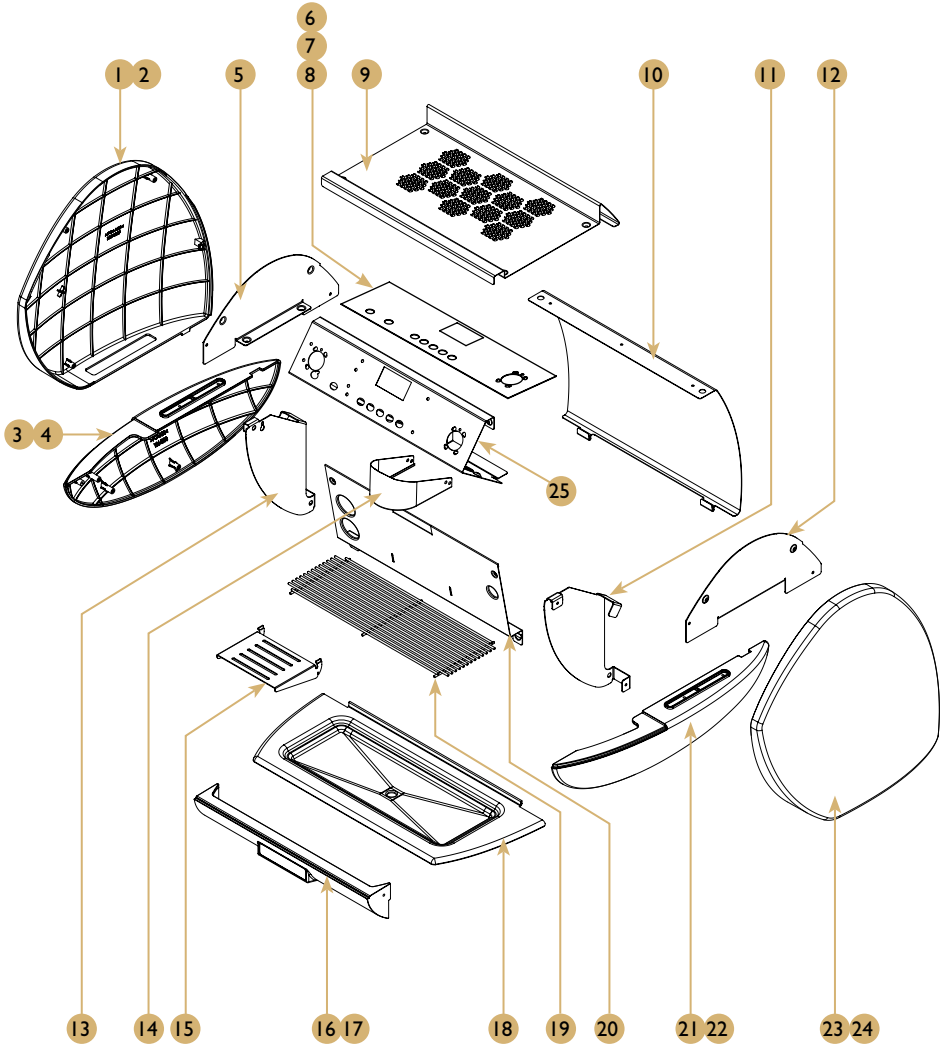

Machine with IGR

Spare parts list

POS.	PCS	Part No.	Description
1	1	1264089	Left panel upper white
2	1	1264162	Left panel upper black
3	1	1264090	Left panel lower white
4	1	1264163	Left panel lower black
5	1	260712	Left Upper Panel Cover
6	1	1264096	Display overlay IGr TS
7	1	1264119	Display overlay IGr TSTB
8	1	1264141	Display overlay IGr Standard
9	1	260719	Top Cup Tray IGR Carat
10	1	260718	Back Panel IGR Carat
11	1	260715	Right Lower Panel Cover
12	1	260714	Right Upper Panel Cover
13	1	260713	Left Lower Panel Cover
14	1	260720	Group Cover Support Carat
15	1	260687	Cup Holder Carat
16	1	1264104	Front Brand Panel
17	1	1264167	Front brand panel IGr black
18	1	260716	Drip Tray IGR Carat
19	1	260717	Grid Carat IGr
20	1	260710	Front Panel IGR Carat
21	1	1264092	Right panel lower white
22	1	1264165	Right panel lower black
23	1	1264091	Right panel upper white
24	1	1264164	Right panel upper black
25	1	260711	Display Panel Assy IGR Carat

Machine with 2GR

Drawing

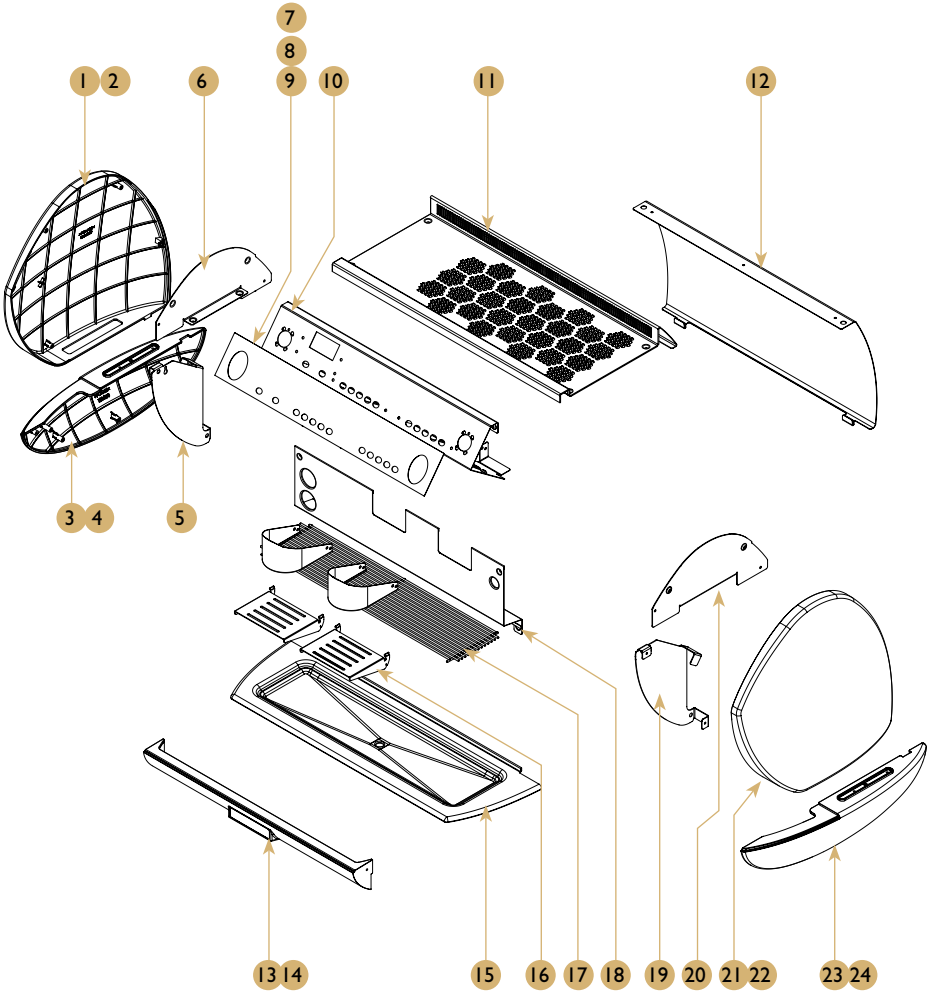

Machine with 2GR

Spare parts list

POS.	PCS	Part No.	Description
1	1	1264089	Left panel upper white
2	1	1264162	Left panel upper black
3	1	1264090	Left panel lower white
4	1	1264163	Left panel lower black
5	1	260713	Left Lower Panel Cover
6	1	260712	Left Upper Panel Cover
7	1	1264116	Display overlay 2Gr TS
8	1	1264120	Display overlay 2Gr TSTB
9	1	1264142	Display overlay 2Gr Standard
10	1	260728	Display Panel Assy 2Gr Carat
11	1	260730	Top Cup Tray 2Gr Carat
12	1	260699	Back Panel 2Gr Carat
13	1	1264115	Front brand panel 2Gr white
14	1	1264166	Front brand panel 2Gr black
15	1	260731	Drip Tray 2Gr Carat
16	2	260687	Cup Holder Carat
17	13	260700	Grid Carat 2Gr
18	1	260729	Front Panel 2Gr Carat
19	1	260715	Right Lower Panel Cover
20	1	260714	Right Upper Panel Cover
21	1	1264091	Right panel upper white
22	1	1264164	Right panel upper black
23	1	1264092	Right panel lower white
24	1	1264165	Right panel lower black

Rotary pump

Drawing

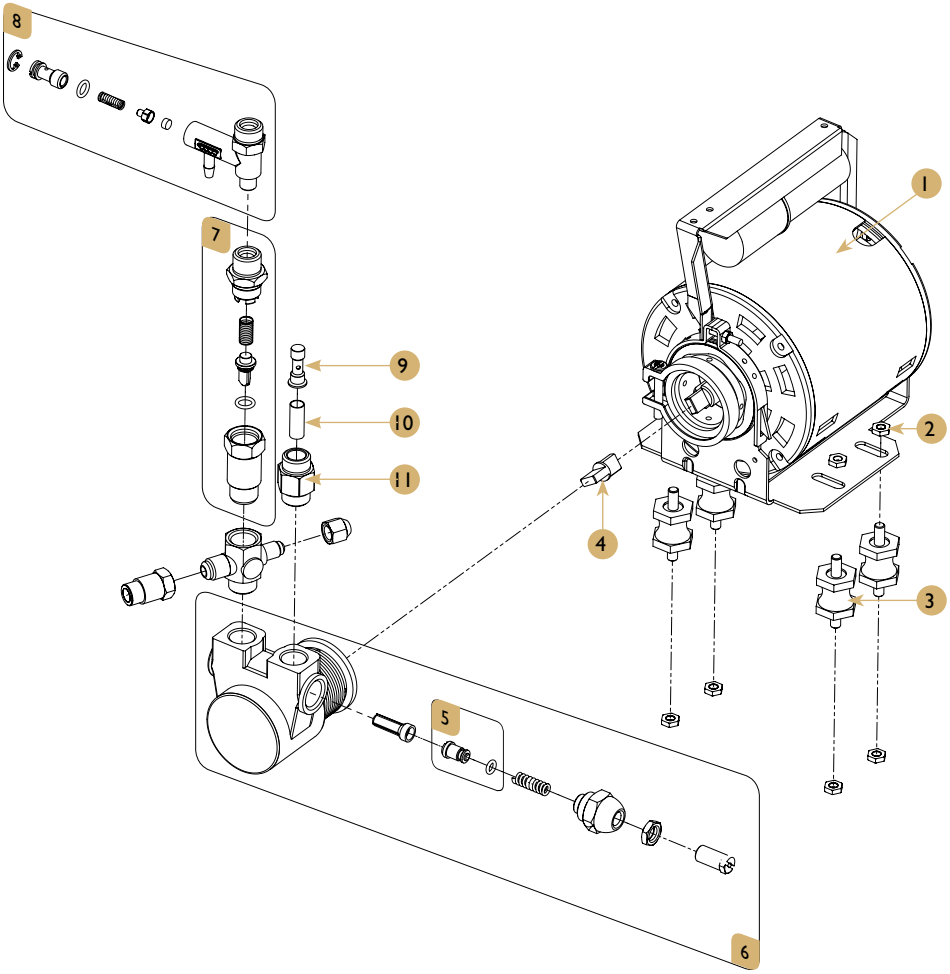

Rotary pump

Spare parts list

POS.	PCS	Part No.	Description
1	1	C60000016	MOTOR CREM 230V/50HZ
2	8	C25093420	HEXAGONAL NUT M-6 DIN-934
3	4	C50100000	SILENTBLOCK M-6
4	1	C30000019	CARDAN JOINT PUMP
5	1	C60000031	Piston Bypass Pump (Tec)
6	1	C60000030	Pump(Crem Special Treatment)
7	1	C65000010	Retention Valve 3/8*1/8 (Min-Mon-Ec)
8	1	C30400055	Pump Bypass Conдор
9	1	C30100100	Inlet Water Filter Holder
10	1	C70000009	Tubular Group Filter
11	1	C30000240	PUMP ADAPTOR 3/8 X 3/8

Boiler IGR

Drawing

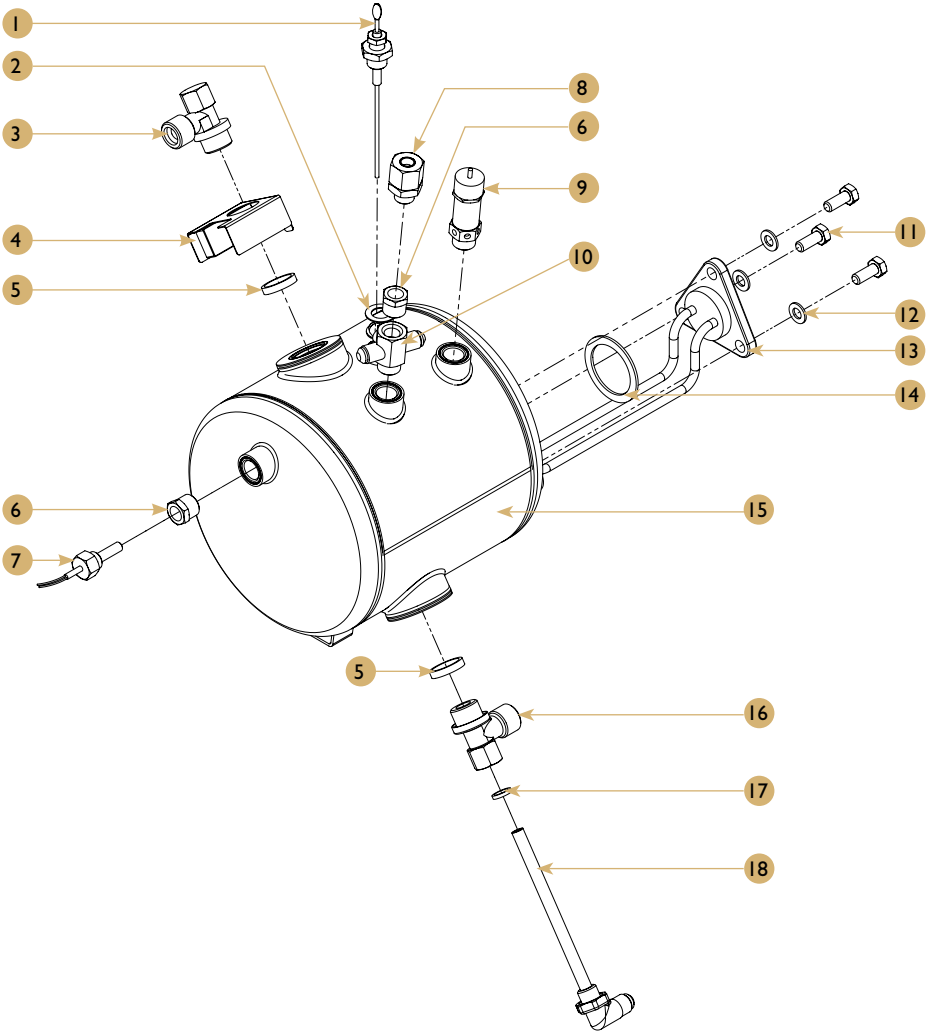

Boiler IGR

Spare parts list

POS.	PCS	Part No.	Description
1	1	C60100040	WATER LEVEL PROBE 1/4
2	1	C25000003	INOX GROUND WASHER
3	1	C30000200	THERMICS SUP.ADAPTOR 1/2 X 1/2
4	1	CESC00100	MAGNETS SET
5	2	C50010010	21.1*25.7* 1/2 TEFLON GASKET
6	2	C30000003	REDUCER MALE-FEMALE-3/8 - 1/4
7	1	C60100076	TEMP. PROBE + SUSP. STEAM PIPE ICD
8	1	C65000200	NON SUCTION VALVE
9	1	C65000100	3/8 SAFETY VALVE
10	1	C30000110	3 TRACKS ADAPTOR 1/4 * 1/4 * 1/8
11	3	C25093320	HEXAGONAL HEAD SCREW 8x20 DIN 933
12	3	C25012530	FLAT WASHER M-8 DIN-125
13	1	C38025001	2500W-230V- 6ltrs.COPPER ELEMENT
14	1	C50010030	40*52*2 ELEMENT TEFLON GASKET
15	1	C15100018	BOILER COPPER IGR 6L
16	1	C30000210	THERMICS INF.ADAPTOR-1/2X1/2X1/4
17	3	C50010050	3/8 BOILER'S CONNECTOR TEFLON GASKE
18	1	C30000220	CONE INJECTOR 1/4

Boiler 2GR

Drawing

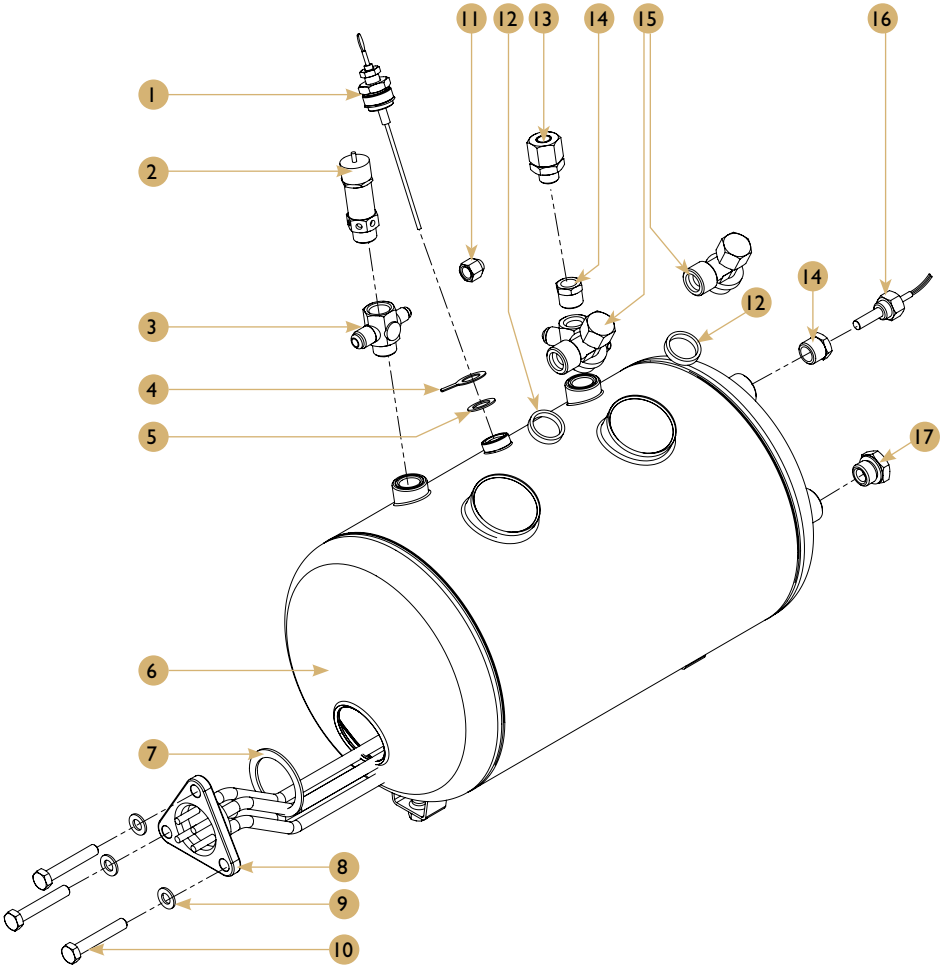

Boiler 2Gr

Spare parts list

POS.	PCS	Part No.	Description
1	1	C60100040	WATER LEVEL PROBE 1/4
2	1	C65000100	3/8 SAFETY VALVE
3	1	C30000100	2 TRACKS ADAPTOR- 1/4 x 1/8
4	1	C25000003	INOX GROUND WASHER
5	1	C25679812	M12 Washer
6	1	C15100020	BOILER 2GR 1 ILTS.
7	1	C50010030	40*52*2 ELEMENT TEFLON GASKET
8	1	C38027000	3050W.230V- 2gr ELEMENT
9	3	C25012530	FLAT WASHER M-8 DIN-125
10	3	C25093320	HEXAGONAL HEAD SCREEW 8x20 DIN 933
11	1	C30000315	BLING PLUG 1/8 FEMALE
12	4	C50010010	21.1*25.7* 1/2 TEFLON GASKET
13	1	C65000200	NON SUCTION VALVE
14	2	C30000003	REDUCER MALE-FEMALE-3/8 - 1/4
15	2	C30000200	THERMICS SUP.ADAPTOR 1/2 X 1/2
16	1	C60100076	TEMP. PROBE + SUSP. STEAM PIPE ICD
17	1	C30000290	PLUG M 3/8

Heat exchanger

Drawing

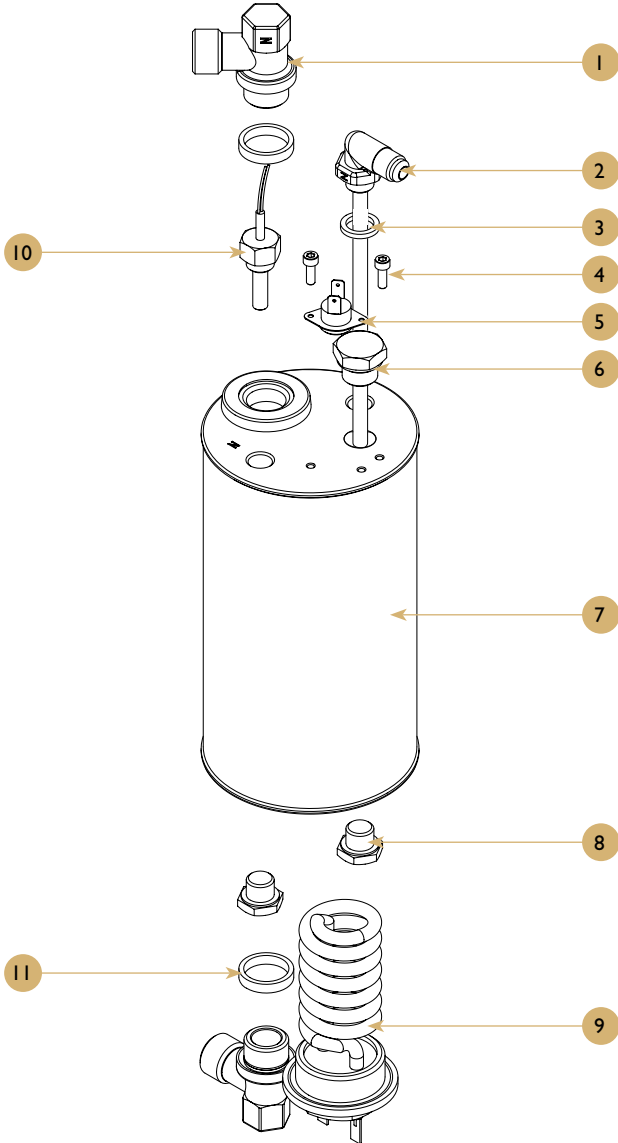

Heat exchanger

Spare parts list

POS.	PCS	Part No.	Description
1	2	C30000200	THERMICS SUP.ADAPTOR 1/2 X 1/2
2	1	C30000220	CONE INJECTOR 1/4
3	1	C50010020	13.2*18.2*2.5 1/4 TEFLON GASKET
4	2	C25091210	ALLEN SCREW 4x12 DIN-912
5	1	C10200110	OFFICE THERMOSTAT 16 A
6	1	C30000290	PLUG M 3/8
7	1	C15100010	OFFICE CAPPUCCINATOR BOILER
8	2	C30000300	BLIND PLUG 1/4 MALE
9	1	C38012000	1200W-230V OFFICE ELEMENT
10	1	C60100076	TEMP. PROBE + SUSP. STEAM PIPE ICD
11	2	C50010010	21.1*25.7* 1/2 TEFLON GASKET

Turbo steamer

Drawing

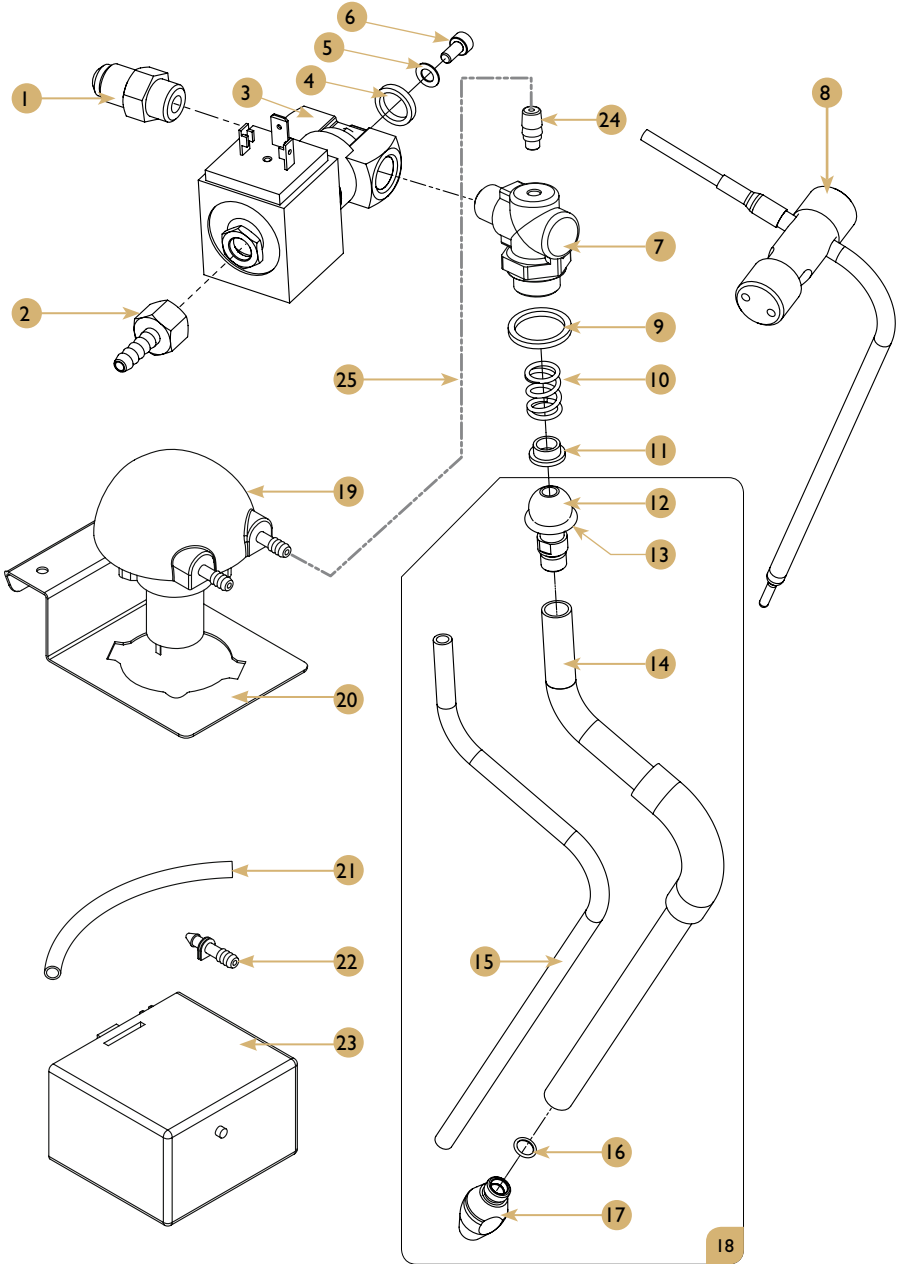

Turbo steamer

Spare parts list

POS.	PCS	Part No.	Description
1	1	C30000510	Conical Adaptor 1/4*1/4 Electron
2	1	C30700000	6Mm Barbfitting 1/8 F
3	1	C60000120	Valve Turbo Steamer
4	1	C50010050	3/8 Boiler's Connector Teflon Gaske
5	1	C25012510	Washer M-5 Din9021
6	1	C25091200	Allen Screw 4X8 Din-912
7	1	C30000235	Male Adapter 1/4*3/8*M-5 Water
8	1	C60100075	Steam Temperature Sensor
9	1	C50010080	Gasket Tap Steam/Water Teflon
10	1	C30370076	Spring Steam/Water Tap
11	1	C30370077	Gasket Tap Steam/Water Brass
12	1	C30370170	Rotate Connector For Steam Tube
13	1	C30370075	O-Ring For Steam Tap
14	1	1364018	Steam Tap Tube 10x1x220mm
15	1	C35021015	Tube Ptfе 4-6
16	1	C50010090	O-Ring 6X1
17	1	C30370180	Nozzle Steam Tap 4H M8.5 With Oring
18	1	C35010051	No Burn Steam Pipe High Group Mega
19	1	C60000049	Peristaltic Pump
20	1	C20010006	Peristaltic Pump Support
21	1	C35021011	Silicone tube for pump
22	2	C35021012	Tube connector for pump
23	1	C60100049	Adjustable Unit Trimmer
24	1	C30500005	Male Hose Adapter Elow
25	-	C35021000	Tube silicon 4-7

Steam wand

Drawing

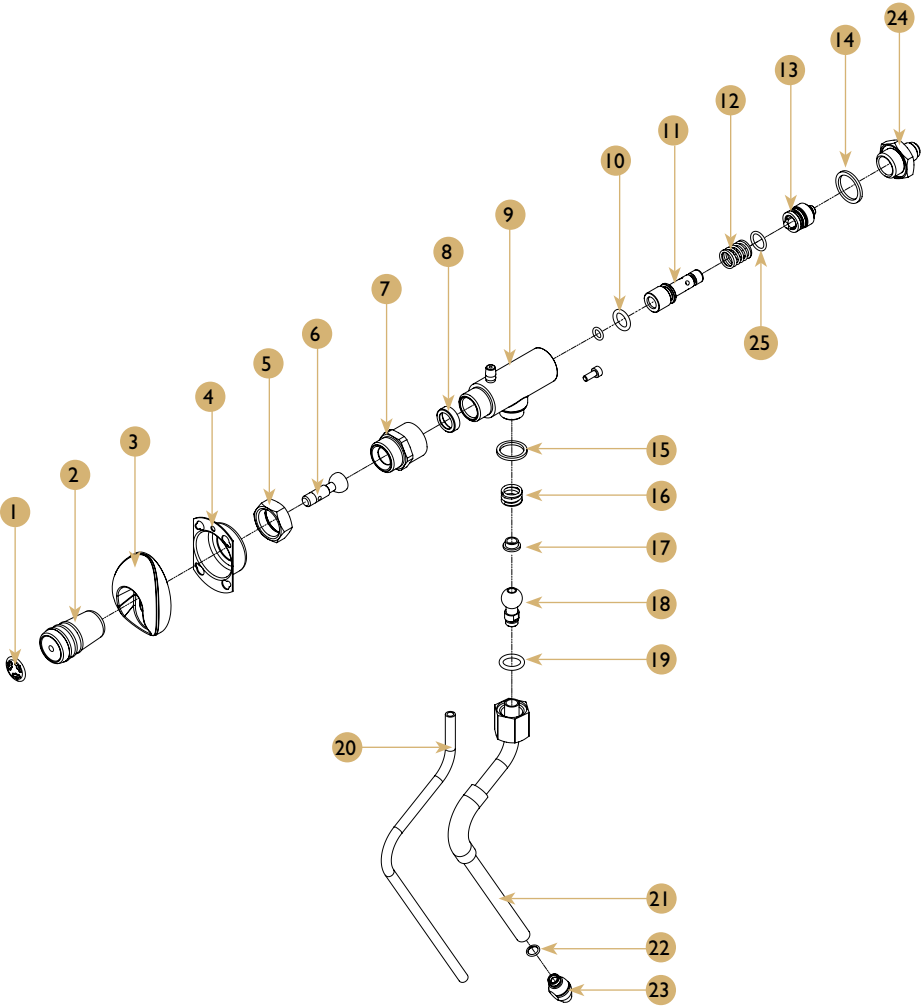

Steam wand

Spare parts list

POS.	PCS	Part No.	Description
1	1	1665068	Sticker Steam Knob OD18.8mm
2	1	C40000061	Steam Knob
3	1	C21003041	Tap Cover
4	1	C00000160	Metal Holder
5	1	C30370141	Nut G5/8 * H26
6	1	C30370161	Tap axle with nob
7	1	C30370165	Conector FemaleG1/2-Male G5/8
8	1	C30370164	Holder washer
9	1	C15000338	Tap Body and Steam Knob
10	1	C50000133	O-ring (10.77x2.62)
11	1	C30370163	Extension axle for tap
12	1	C55000070	Spring, 14X24x1,5-OA2
13	1	C30369150	Support guide
14	1	C50010070	Teflon gasket (19X24x2)
15	1	C50010080	Gasket Tap Steam/Water Teflon
16	1	C30370076	Spring Steam/Water Tap
17	2	C30370077	Gasket Tap Steam/Water Brass
18	1	C30370170	Rotate Connector for Steam Tube
19	2	C30370075	O-Ring for Steam Tap
20	1	C35021015	Tube PTFE 4-6
21	1	1364018	Steam Tap Tube 10x1x220mm
22	1	C50010090	O-ring 6X1
23	1	C30370180	Nozzle steam tap 4H M8.5 with Oring
24	1	C30370166	Connector 3/4M x G14M
25	1	C50000100	O-Ring 6.07x1.78

Hot water outlet

Drawing

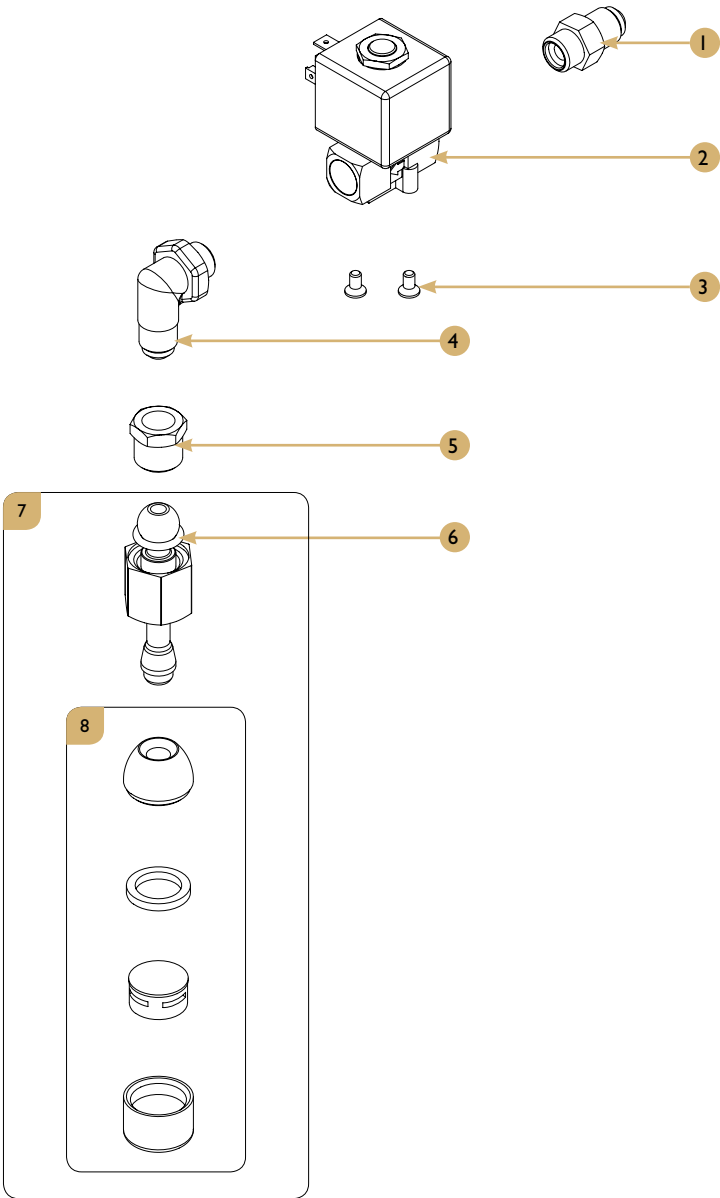

Hot water outlet

Spare parts list

POS.	PCS	Part No.	Description
1	1	C30000510	CONICAL ADAPTOR 1/4*1/4 ELECTRON
2	1	C60000100	1/4 x 1/4 ELECTROVALVE PARKER 220V
3	2	C25096510	ROSE SCREW PHILIPS 4*8 (DIN 965)
4	1	C30000215	CONICAL BEND ADAPTOR 1/4 X 1/4
5	1	C30000003	REDUCER MALE-FEMALE-3/8 - 1/4
6	1	C30370075	O-Ring for Steam Tap
7	1	C30370080	Hot Water Tap Classic
8	1	C30000050	Nozzle Water Tap Complete

Group head

Drawing

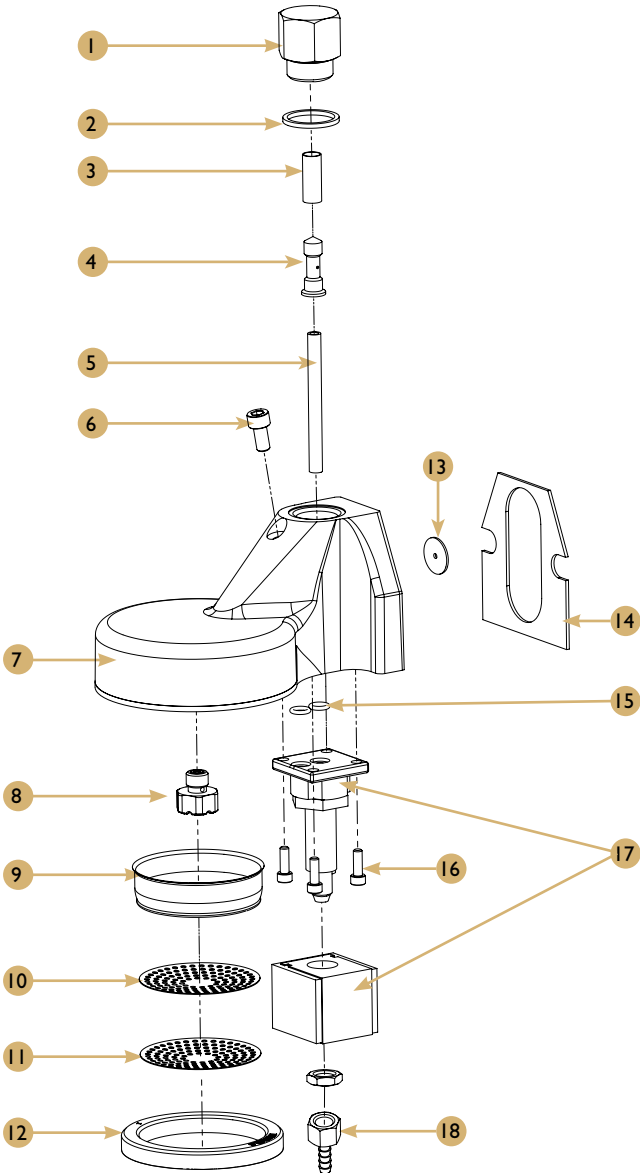

Group head

Spare parts list

POS.	PCS	Part No.	Description
1	1	C30200035	LONG PLUG 1/2 GROUP
2	1	C50010040	21.7*25.7*2 G/C-G TEFLON GASKET
3	1	C70000009	TUBULAR GROUP FILTER
4	1	C30200061	GROUP TEFLON INJECTOR Rev3
5	1	C30200026	TEFL WATER REDUC. HOLDER 4X6X65
6	1	C25091250	ALLEN SCREW 6*10 DIN-912 GROUP
7	1	C30200010	CREM BREWING GROUP BODY
8	1	C30200040	DIFFUSER
9	2	C75000010	SHOWER
10	1	C75000085	Filter 9mm
11	1	C75000083	Filter 8.5mm
12	1	C75000081	8mm GROUP HEAD GASKET
13	1	C50020020	2.5*18.2*2 TEFLON HOT WATER REDUCTO
14	1	C50000010	GREEN BODY FLAT GROUP JOINT
15	1	C50000100	O-Ring 6.07*1.78
16	4	C25091211	Allen Screw M4x16 DIN 912
17	1	C60000112	GRO HEAD ELECTROV. PARKER 220V
18	1	C30700000	6mm barbfitting 1/8f

Lower water system

Drawing

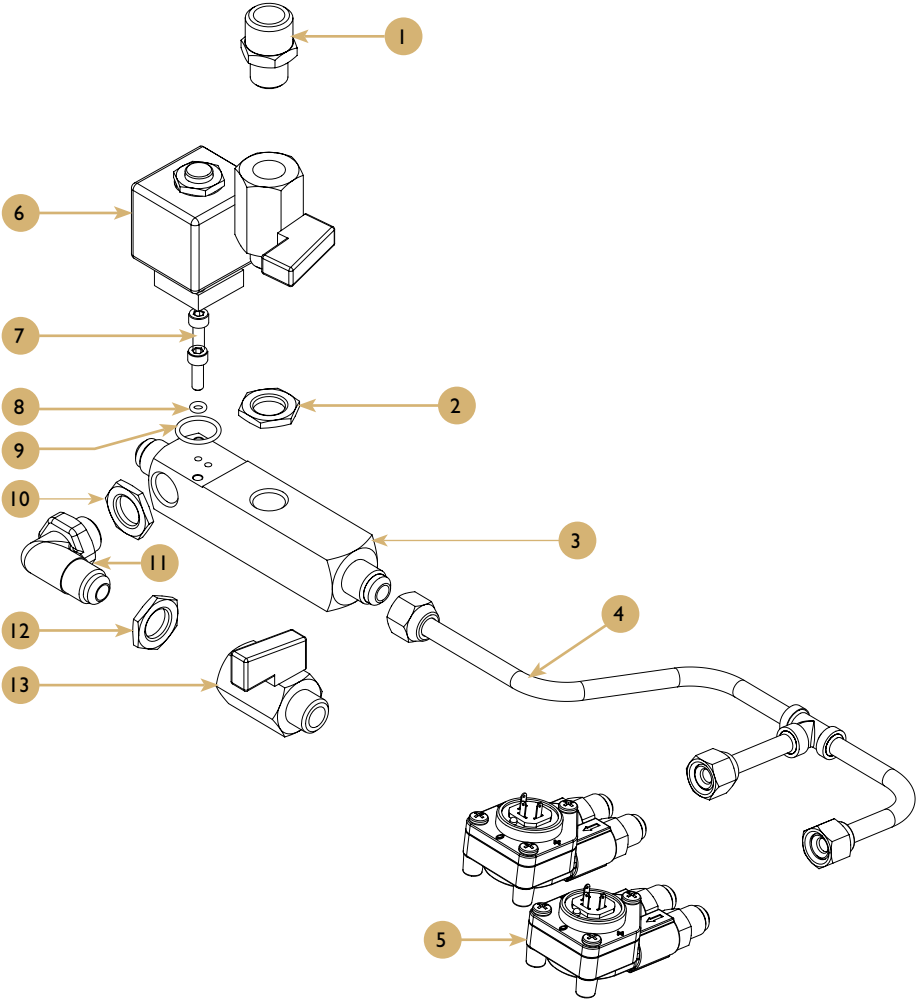

Lower water system

Spare parts list

POS.	PCS	Part No.	Description
1	1	C3000002	BUTTRESS 1/4-3/8 MINI
2	1	C30100010	HEXAGONAL NUT 1/4 PRESSOSTAT
3	1	C30100033	DISTRIBUTOR MC
4	1	I364029	Distributor Tube ø8mm Carat 2Gr
4	1	I364021	Copper Tube 8.0*100mm 1Gr
5	2	C60100045	FLOWMETER UL/NETW. BRASS TEF+LED
6	1	C60000105	50/60HZ 220V SOLENOID ELECTROVALVE
7	2	C25091210	ALLEN SCREW 4x12 DIN-912
8	1	C50000110	SMALL AUTOFILL SOLENOID GASKET
9	1	C50000105	LARGE AUTOFILL SOLENOID GASKET
10	1	C30100010	HEXAGONAL NUT 1/4 PRESSOSTAT
11	1	C30000215	CONICAL BEND ADAPTOR 1/4 X 1/4
12	1	C30100010	HEXAGONAL NUT 1/4 PRESSOSTAT
13	2	I860016	Tap drainage G1/4M-G1/4F Right

Porta-filter

Drawing

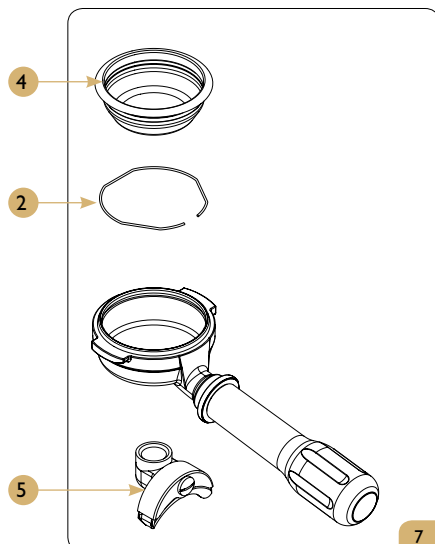
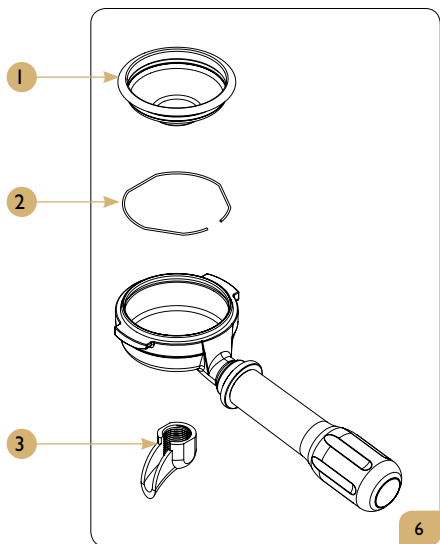

Spare parts list

POS.	PCS	Part No.	Description
1	1	C75000031	1 CUP FILTER (7GR)
2	2	C75000120	FILTER SPRING
3	1	C75000050	Spout 1Cup
4	1	C75000041	2 CUP FILTER (14GR)
5	1	C75000060	Spout 2Cups
6	1	C75001500	PORTAFILTER 1 CUP STD incl FILTER
7	1	C75002500	PORTAFILTER 2 CUPS STD Incl FILTER



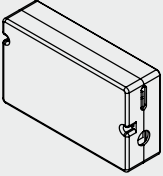
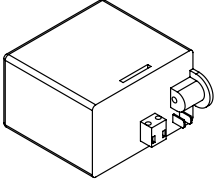
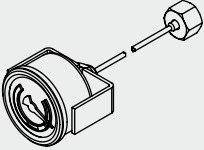
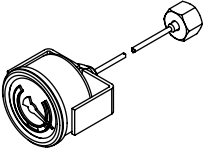
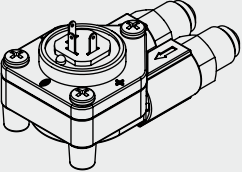
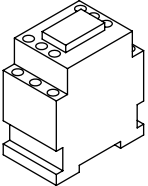

Machine components

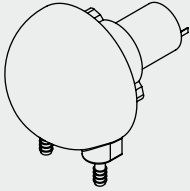
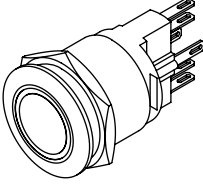
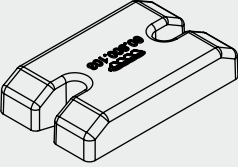
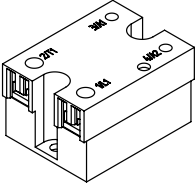
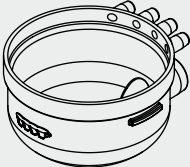
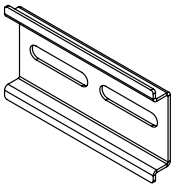
DRAWING	PART NO.	MODEL/NAME
	C60100420	Main control box
	C60100049	Centralita Trimer Regulable 230V
	C60000072	Manometro D40 0_16 BAR
	C60000052	Manometro D40 0_2.5 BAR
	C60100045	Flowmeter UL Red TEF Led
	I602231	Relay 230V VAC I00-C09KF10

Machine components

DRAWING	PART NO.	MODEL/NAME
	C6000049	Peristaltic Air Pump
	I660036	Power Switch Blue 22mm
	C60800103	Solid State Relay Cover
	C60800101	STATIC RELAY 4-32
	C70001000	DRAIN FILTER + HIGH GROUP
	I60546	DIN Connection 65MM<M>

Machine components

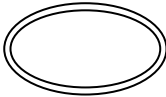
DRAWING	PART NO.	MODEL/NAME
	<p>I666031</p>	<p>Turbo steamer cable</p>
	<p>I666032</p>	<p>NTC extension cable</p>
	<p>I666039</p>	<p>Signal cable</p>
	<p>C16660028</p>	<p>Harness complete Carat 1Gr</p>
	<p>C16660029</p>	<p>Harness complete Carat 2Gr</p>
	<p>C60102020</p>	<p>O-ring flowmeter</p>

Machine components

Drawing

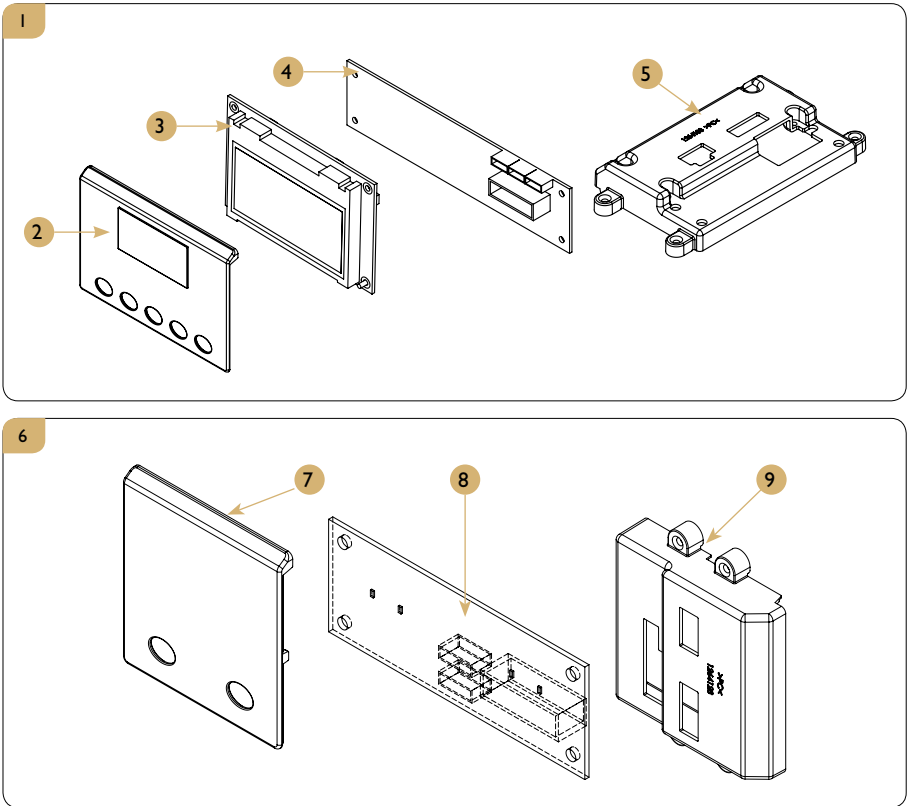

Spare parts list

POS.	PCS	Part No.	Description
1	1	2760058	Display PCB Assy Capa Carat 1Gr
2	1	1264139	Display PCB Box Upper 5Key 1Gr Capa
3	1	C60101060	Graphic Display Gicar
4	1	1660041	PCB Capacitive Type 5 Buttons
5	1	1264108	Display PCB Box Bottom Carat
6	1	2760059	PCB Box Assy 2 Buttons Capa Carat
7	1	1264129	Display PCB Box Upper 2 Buttons
8	1	1660042	PCB Capacitive Type 2 Buttons
9	1	1264128	Display PCB Box Bottom 2 Buttons

Machine components

Drawing

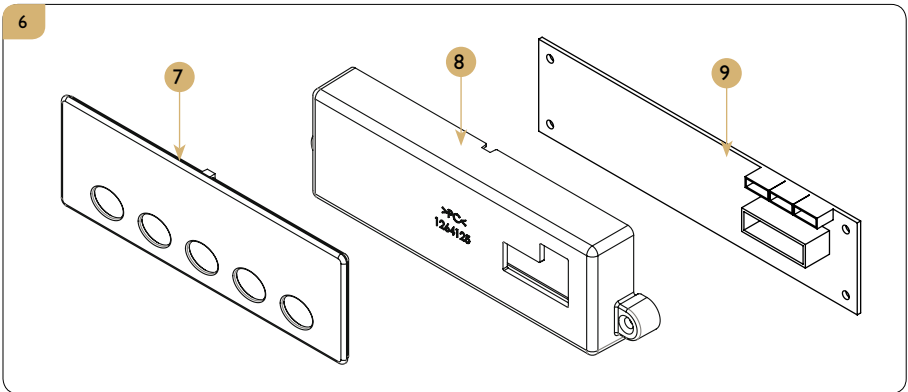
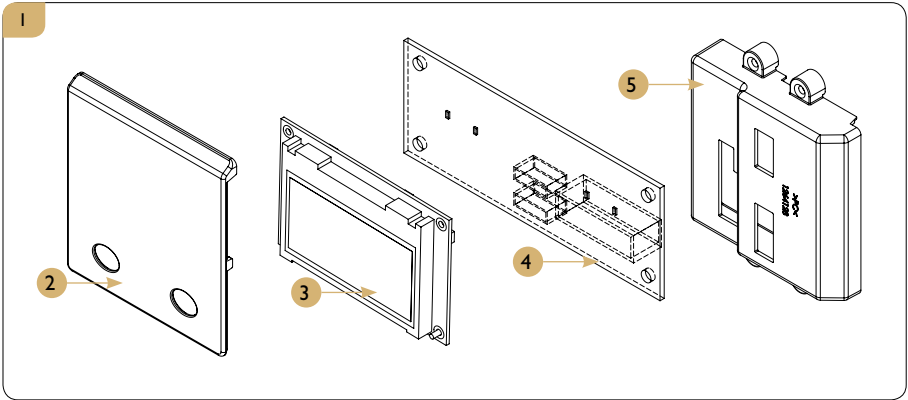

Spare parts list

POS.	PCS	Part No.	Description
1	1	2760060	Display Assy with 2 Button Carat TB
2	1	1264129	Display PCB Box Upper 2 Buttons
3	1	C60101060	Graphic Display Gicar
4	1	1660042	PCB Capacitive Type 2 Buttons
5	1	1264128	Display PCB Box Bottom 2 Buttons
6	1	2760061	Button Box Assy Carat TB
7	1	1264126	Button Box Upper
8	1	1264125	Button Box Bottom
9	1	1660041	PCB Capacitive Type 5 Buttons

Machine components

Drawing

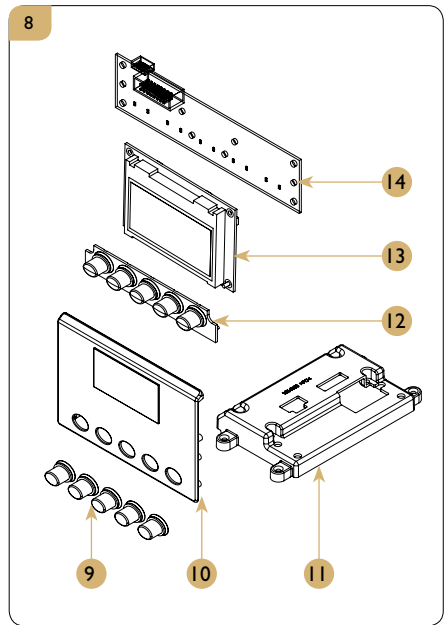
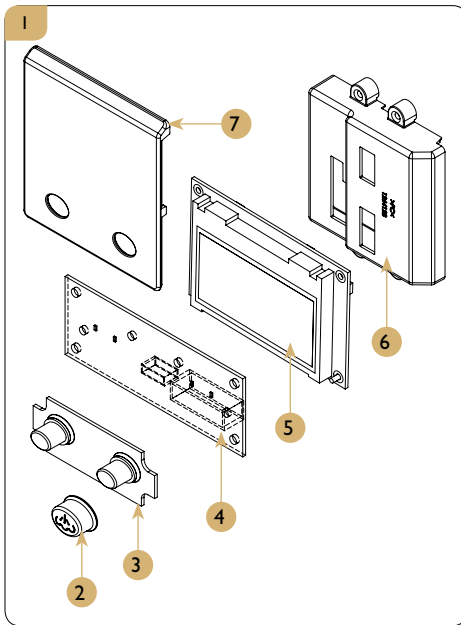

Spare parts list

POS.	PCS	Part No.	Description
1	1	2760062	Display PCB Assy with 2 Buttons
2	1	C*60101513	Metal button set cover water/steam
3	1	1264156	Conductive Control Button 2 Keys
4	1	1660040	PCB Mechanical Type 2 Buttons
5	1	C60101060	Graphic Display Gicar
6	1	1264128	Display PCB Box Bottom 2 Buttons
7	1	1264129	Display PCB Box Upper 2 Buttons
8	1	2760031	Display PCB Assembly Carat
9	1	C*60101512	METAL BUTTON SET COVER (x5)
10	1	1264107	Display PCB Box Upper Carat
11	1	1264108	Display PCB Box Bottom Carat
12	1	1264095	Conductive Control Button
13	1	C60101060	Graphic Display Gicar
14	1	1660039	PCB Mechanical Type 5 Buttons

Machine components

Drawing

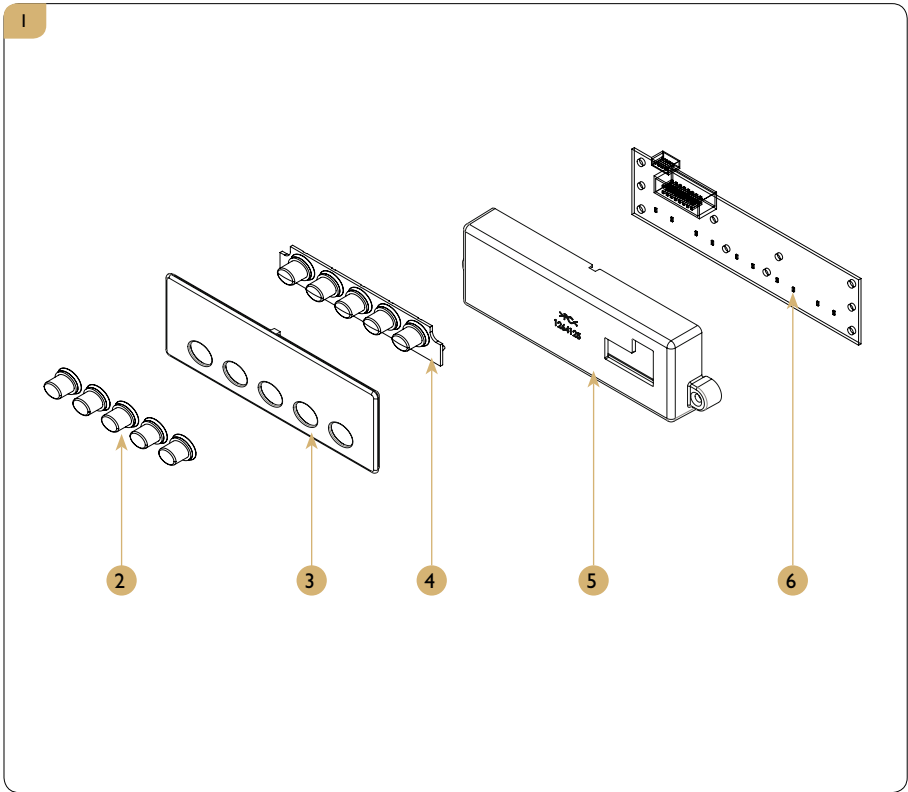

Spare parts list

POS.	PCS	Part No.	Description
1	1	1264124	Button Box Assy Carat
2	1	C*60101512	METAL BUTTON SET COVER (x5)
3	1	1264126	Button Box Upper
4	1	1264095	Conductive Control Button
5	1	1264125	Button Box Bottom
6	1	1660039	PCB Mechanical Type 5 Buttons

For the warranty to be valid the conditions for maintenance must have been followed according to our instructions, proper precaution has been made and warranty claim been issued without delay.

The affected equipment may not be used during awaiting service if there is any risk that the damage or defect would worsen.

The warranty will not cover consumption supplies such as glassware, normal maintenance such as cleaning of filters, contaminations in water, lime, incorrect voltages, pressure or adjustment of water amounts.

The warranty will not cover damages of defects caused by incorrect handling and operation of the appliance.

FOR SERVICE

Please contact your dealer

Your Dealer

