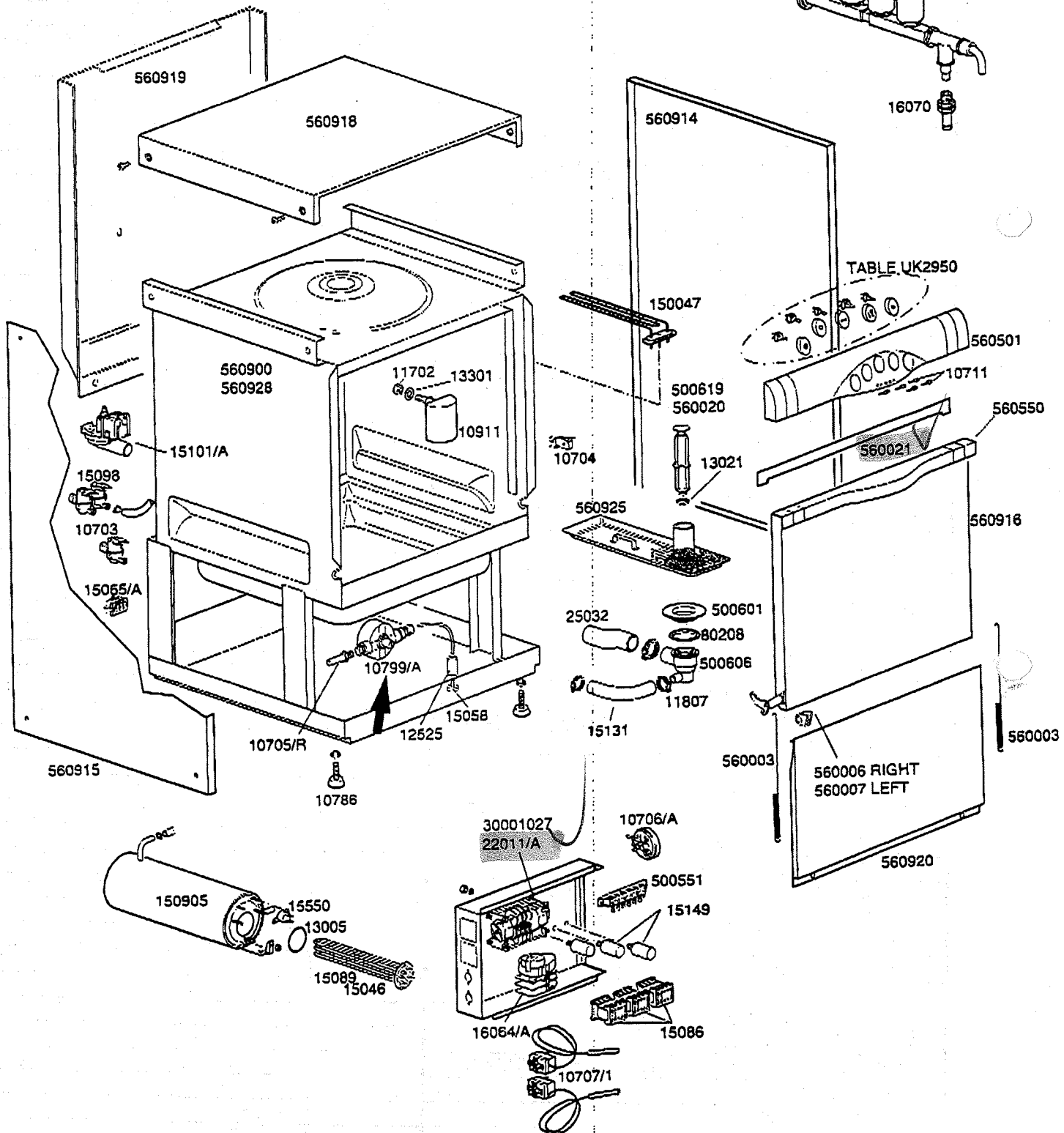



TABLE REV
UK2910 06

TEKNO 6

FROM SERIAL NR.99015438 ON



TEKNO D-DISHWASHER

TABLE
UK2910

CODE	DESCRIPTION	CODE	DESCRIPTION
10703	Single solenoid valve	15101/A	Drain pump with orientable spiral
10704	Door microswitch	11127	M6x20 stainless steel screw
10711	Small green pilot light	11168	M6x12 Stainless steel screw
10770	Insulator for microswitch	16064/A	Timer 18 min. water conditioning
10786	Black M10x25 d.40 foot	16067/A	OR Gasket for salt container plug
10911	Air tarp	16067/B	Salt container gasket
11702	M8 stainless steel nut	16067/C	Ring nut for salt container
11807	Stainless steel clamp 12-22	16067/D	Salt container plug
12525	Counterweight for small filter	22011/A	Timer 2/4 200Vac. 50Hz
13005	OR 151 gasket	15381	150VA 0/230V - 0/400-415-440V Trasn. ←
13021	DEM 40 gasket		
13301	14x8x1,5 gasket		
15046	Boiler heating element 3000W		
15058	Suction filter		
15086	Electromagnetic switch 230V 50-60Hz 4C		
15089	Boiler resistance 4500W		
15098	Double solenoid valve		
15131	Tube rony-flex 30-450		
15146	Interference suppressor filter F1		
15149	Interference suppressor filter F3		
15550	Contact safety thermostat		
16066	Water softener 4 elements		
16065	Salt container		
16070	Check valve		
16082	Funnel		
25032	Suction coupling		
80208	95x75x3 gasket		
150047	Tank resistance 2700W		
150905	Boiler		
500551	6 pole-terminal board FV122		
500601	Ferrule		
500606	Right side drainage trap		
500619	Overflow		
560003	Spring door		
560006	Right gasket for spring		
560007	Left gasket for spring		
560020	Overflow (Drain pump version - from March 1999)		
560021	Gasket for doorstop		
560501	Control panel		
560550	ABS grey handle		
560900	Stainless steel structure		
560914	Right side panel		
560915	Left side panel		
560916	Plastic handle support assembly		
560918	External front plastic cover		
560919	Back panel		
560920	Under door panel		
560925	Surface filter		
560928	Stainless steel structure CFD		
30001027	2-Time timer		
30001031	2 time timer 120°/180°230V 50Hz+TM-PS		
10705/R	Fitting for pipe d.8		
10706/A	Manostat 55-30		
10707/1	Thermostat 0-90° TR2 without shaft		
10709/A	3-Way rinser additive measurer		



TABLE
UK2930

REV
02

TEKNO 6

From serial Nr.01011009 on

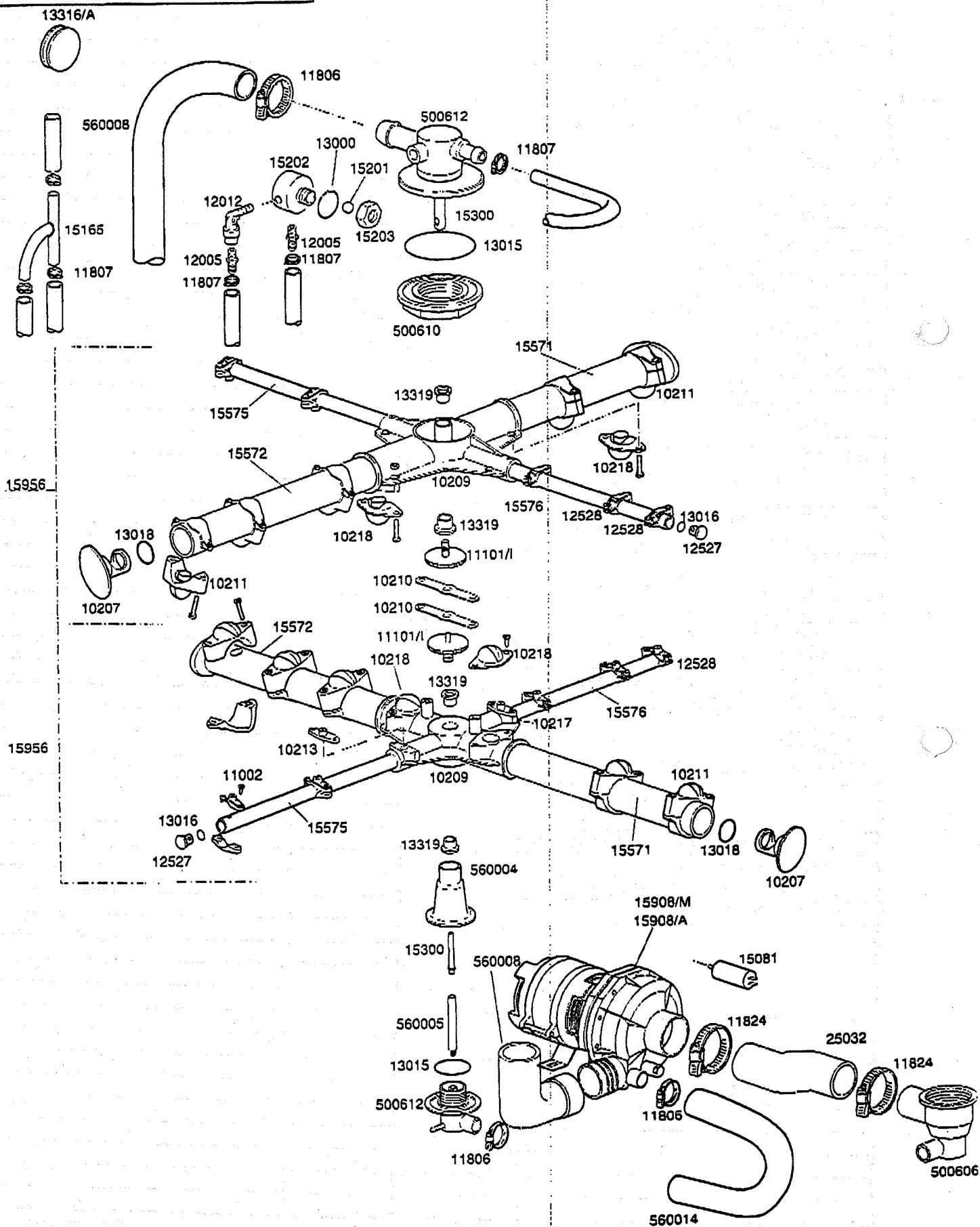



TABLE
UK2950

REV
00

SWITCHES TEKNO 6

SERIES TEKNO 6

Switches

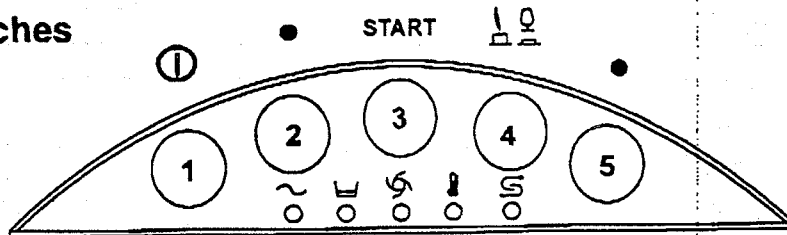

- 1 Cod. 560527
- 2 Cod. 560523
- 3 Cod. 560529
- 4 Cod. 560530
- 5 Cod. 560526

Control

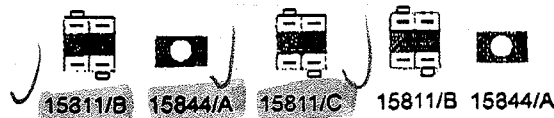

SERIES TEKNO 6 DEPURATION

Switches

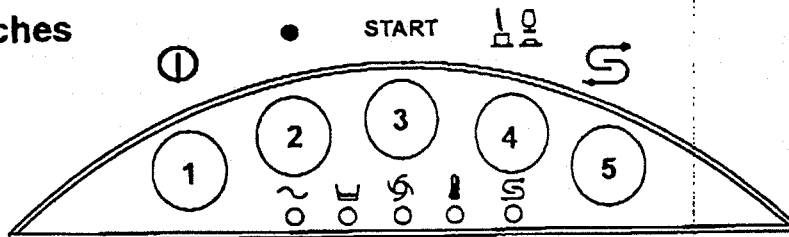

- 1 Cod. 560527
- 2 Cod. 560523
- 3 Cod. 560529
- 4 Cod. 560530
- 5 Cod. 560531

Control

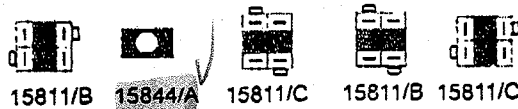

SERIES TEKNO 6 DRAIN PUMP

Switches

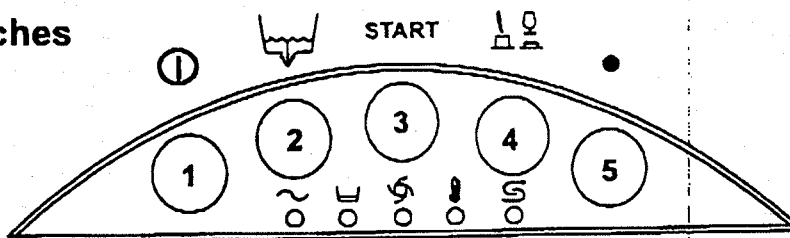

- 1 Cod. 560527
- 2 Cod. 560528
- 3 Cod. 560529
- 4 Cod. 560530
- 5 Cod. 560526

Control



SERIES TEKNO 6 REGENERATION-DRAIN PUMP

Switches

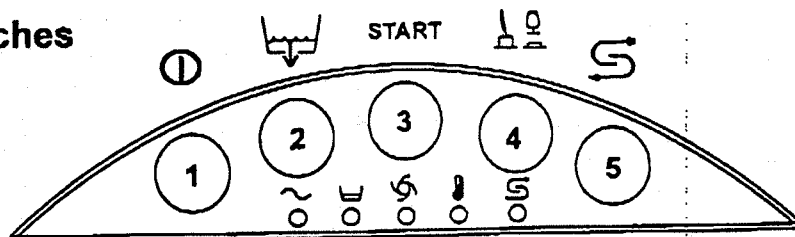

- 1 Cod. 560527
- 2 Cod. 560528
- 3 Cod. 560529
- 4 Cod. 560530
- 5 Cod. 560531

Control



