

	*	**	***
G30-28+30mbar	533091400	533091000	533030100
G31- 37mbar	533091400	533091000	533014700
G30- 50mbar	533091400	533091000	533014700
G20- 20mbar	533091500	533091200	533015200
G25- 25mbar	533091500	533091200	533015200
G20- 20mbar	533091500	533091200	533015200
G25- 20mbar	533091500	533091200	533030300
G25- 25mbar	533091500	533091200	533014900
G25- NL	533091500	533091200	533014900

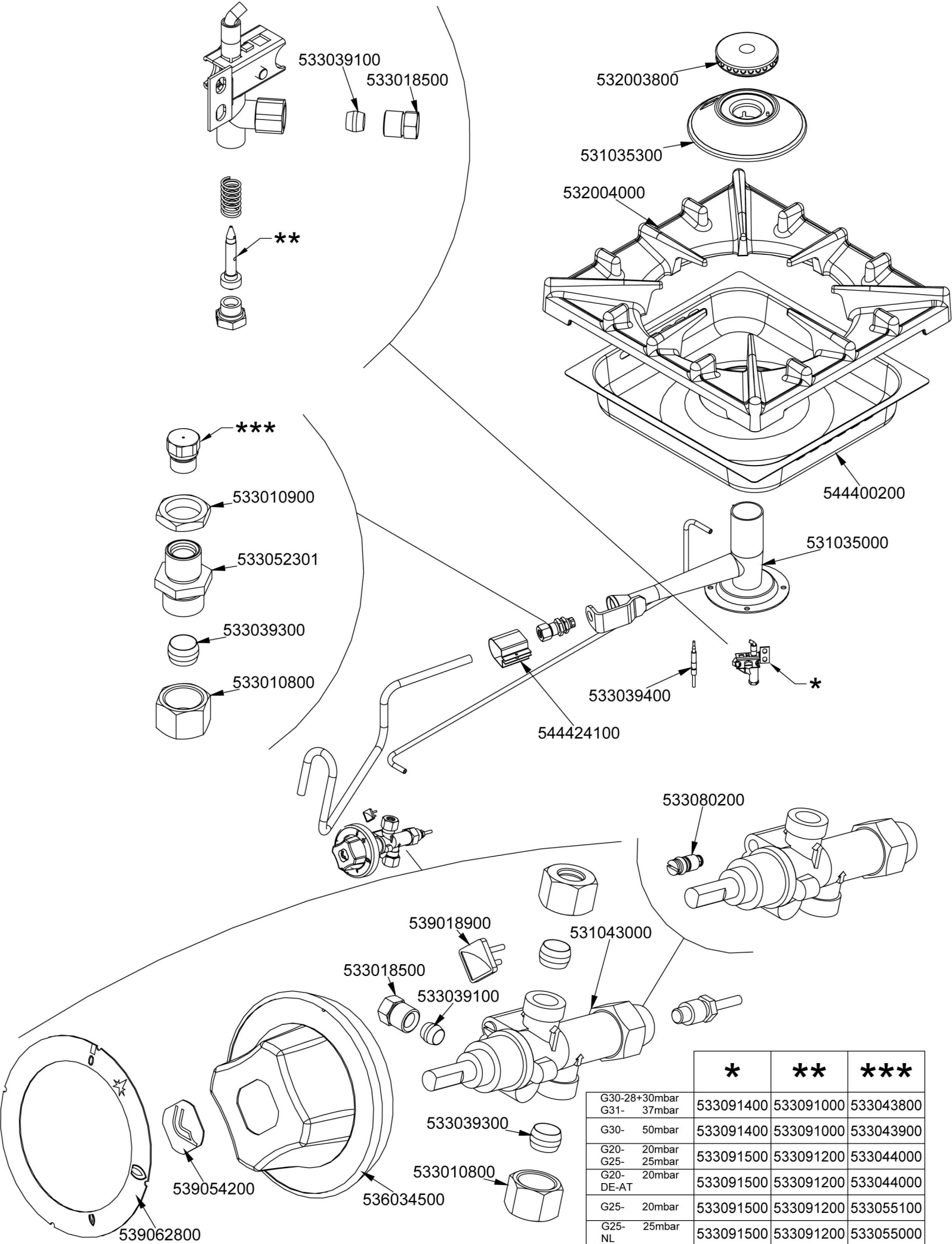

	*	**	***
G30-28+30mbar	533091400	533091000	533043800
G31- 37mbar	533091400	533091000	533043900
G30- 50mbar	533091500	533091200	533044000
G20- 20mbar	533091500	533091200	533044000
G25- 25mbar	533091500	533091200	533055100
G20- 20mbar DE-AT	533091500	533091200	533055000
G25- 20mbar	533091500	533091200	533055000
G25- 25mbar NL	533091500	533091200	533055000

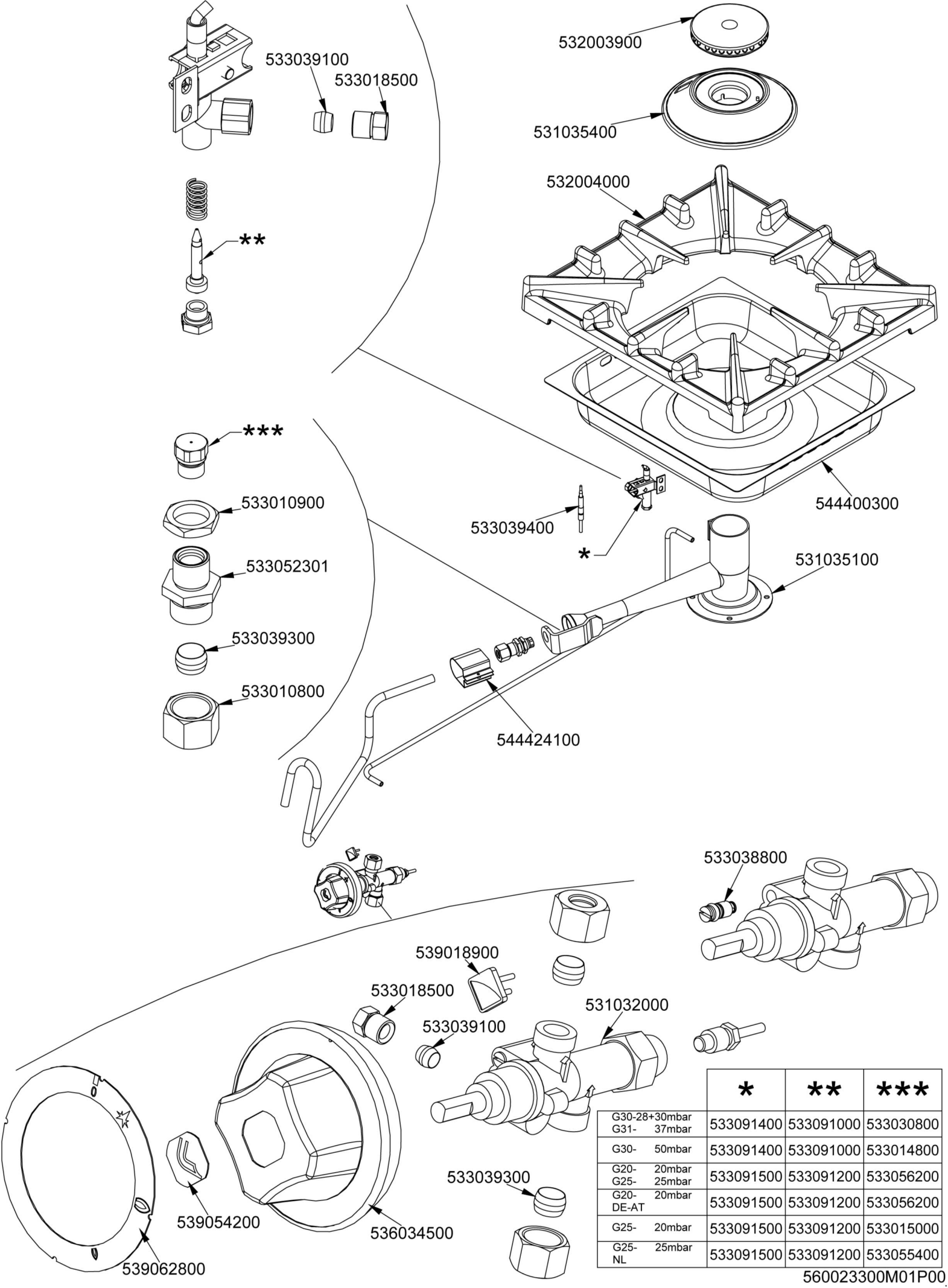

	*	**	***
G30-28+30mbar G31- 37mbar	533091400	533091000	533030800
G30- 50mbar	533091400	533091000	533014800
G20- 20mbar G25- 25mbar	533091500	533091200	533056200
G20- 20mbar DE-AT	533091500	533091200	533056200
G25- 20mbar	533091500	533091200	533015000
G25- 25mbar NL	533091500	533091200	533055400

Page	Pos	Code	Description
001		532004100	FLUE GRID L=370 90LINE (RAF
001		541117200	UPPER PLATE PC-98G
001		544446900	LHD SIDE FOR 90T APPLIANCES
001		541119300	FRONT PANEL PC-98G
001		544446800	
001		533010500	LEG M10*25 D.40
002		533009200	REDUCTION GRATE FOR 65-70LINES+FO
002		532003700	BURNER COVER RING §060
002		531035200	SMALL BURNER BODY 90 LINE
002		533010900	NUT M14*1 H.4
002		533052301	JOINT FOR NOZZLE HOLDER
002		533039300	BICONE §10
002		533010800	TUBE NUT D.10 M16*1,5
002		532004000	1 FLAME GRILL 396X366 (90
002		544400100	BURNER DRIP PAN 2/3
002		531034900	SMALL BURNER VENTURI 90 LINE
002		544424100	AIR ADJUSTMENT BUSHING*BURNER PC90
002		533039100	BICONE §6
002		533018500	FITTING FOR BICONE D.6 M10*1
002		533045700	THERMOCOUPLE M9*1 500
002		539018900	INDEX FOR KNOB W/RED SIGN
002		531042900	B.PASS §60 SAFETY COCK PC/CF 90
002		533069100	BY PASS COCK §60 20S
002		539062800	RED STICKING DISK 72
002		539054200	STAMP Ø20,5 CR. "L" LOTUS R.
002		536034500	KNOB §77 4P. §08*6,5
002		533091400	P.NOZZLE S100 UG.§20 PC90 LPG-FLUS
002		533091500	PILOT NOZZLE S.100 §30 PC90 NAT.GAS
002		533091000	NOZZLE 0.100 §20
002		533091200	PILOT NOZZLE 0100 Ø35 PIL.PC
002		533030100	NOZZLE §95 CH12*14 G-FP
002		533014700	NOZZLE §85 CH12*14 F-FQ5
002		533015200	NOZZLE §145 CH12*14 F-FP/CP6
002		533030300	NOZZLE §160 CH12*14 M-FPG
002		533014900	NOZZLE §150 CH12*14 F-FQ5 L-FQ6
003		533039100	BICONE §6
003		533018500	FITTING FOR BICONE D.6 M10*1
003		532003800	BURNER COVER RING §082
003		531035300	MEDIUM BURNER BODY 90 LINE
003		532004000	1 FLAME GRILL 396X366 (90
003		544400200	BURNER DRIP PAN 2/3
003		533010900	NUT M14*1 H.4
003		531035000	MEDIUM BURNER VENTURI 90 LINE
003		533052301	JOINT FOR NOZZLE HOLDER
003		533039300	BICONE §10
003		533010800	TUBE NUT D.10 M16*1,5
003		533039400	THERMOCOUPLE M9*1*850
003		544424100	AIR ADJUSTMENT BUSHING*BURNER PC90
003		533080200	BY PASS COCK §65 20S-21S
003		539018900	INDEX FOR KNOB W/RED SIGN
003		531043000	GAS COCK 21S P.V. BY-PASS §065

Page	Pos	Code	Description
003		539054200	STAMP Ø20,5 CR."L" LOTUS R.
003		536034500	KNOB §77 4P. §08*6,5
003		539062800	RED STICKING DISK 72
003		533091400	P.NOZZLE S100 UG.§20 PC90 LPG-FLUS
003		533091500	PILOT NOZZLE S.100 §30 PC90 NAT.GAS
003		533091000	NOZZLE 0.100 §20
003		533091200	PILOT NOZZLE 0100 Ø35 PIL.PC
003		533043800	NOZZLE §130 CH12*14 G-CW4
003		533043900	NOZZLE §115 CH12*14 F-CW4
003		533044000	NOZZLE §195 CH12*14 M-CW4
003		533055100	NOZZLE §215 CH12*14 L-CW4
003		533055000	NOZZLE §205 CH12*14 G25 CW4
004		533039100	BICONE §6
004		533018500	FITTING FOR BICONE D.6 M10*1
004		532003900	BURNER COVER RING §100
004		531035400	BIG BURNER BODY 90 LINE
004		532004000	1 FLAME GRILL 396X366 (90
004		533010900	NUT M14*1 H.4
004		533039400	THERMOCOUPLE M9*1*850
004		544400300	BURNER DRIP PAN 2/3
004		533052301	JOINT FOR NOZZLE HOLDER
004		531035100	BIG BURNER VENTURI 90 LINE
004		533039300	BICONE §10
004		533010800	TUBE NUT D.10 M16*1,5
004		544424100	AIR ADJUSTMENT BUSHING*BURNER PC90
004		533038800	75 BY-PASS FOR 21S TAP
004		531032000	GAS COCK P.V.BY-PASS Ø075
004		539018900	INDEX FOR KNOB W/RED SIGN
004		536034500	KNOB §77 4P. §08*6,5
004		539054200	STAMP Ø20,5 CR."L" LOTUS R.
004		539062800	RED STICKING DISK 72
004		533091400	P.NOZZLE S100 UG.§20 PC90 LPG-FLUS
004		533091500	PILOT NOZZLE S.100 §30 PC90 NAT.GAS
004		533091000	NOZZLE 0.100 §20
004		533091200	PILOT NOZZLE 0100 Ø35 PIL.PC
004		533030800	NOZZLE §155 CH12X14 M-CW
004		533014800	NOZZLE §135 CH12*14,0
004		533056200	NOZZLE §230 CH12*14
004		533015000	NOZZLE D.I 260 G110 (TOWN GAS
004		533055400	NOZZLE §245 CH12*14