

LAVASTOVIGLIE INDUSTRIALI
INDUSTRIAL DISHWASHER
LAVE-VAISSELLE INDUSTRIELS
INDUSTRIEGESCHIRRSPÜLER
LAVAVAJILLAS INDUSTRIALES

N45



MANUALE DI RICAMBI
SPARE PARTS

CATALOGUES PIÉCES
ERSATZTEILEKATALOG
CATÁLOGO DE REPUESTOS

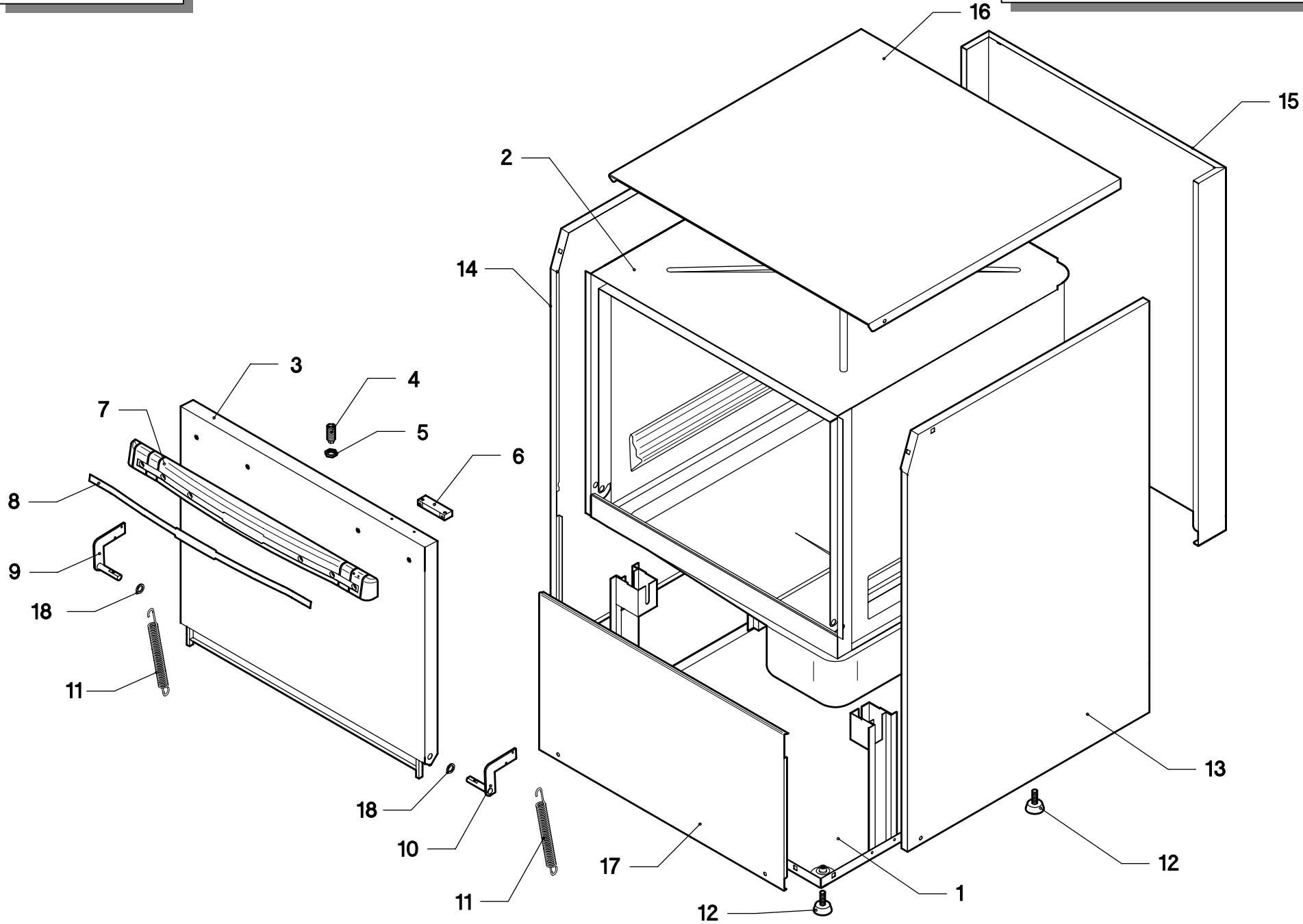

<i>Pos.</i>	<i>COD.</i>	<i>COD.</i>	<i>Q.tà</i>	<i>DESCRIZIONE</i>	<i>DENOMINATION</i>	<i>DESCRIPTION</i>	<i>BEZEICHNUNG</i>	<i>DESCRIPCIÓN</i>
1	900268		1	BASAMENTO	SOCLE	BASE	UNTERSTRUKTUR	BASE
2	901705		1	VASCA	CUVE	TANK	TANK	PILETA
3	905082		1	PORTA	PORTE	DOOR	TÜR	PUERTA
4	906121		1	SCROCCHETTO	CLIQUET FERMETURE PORTE	DOOR CATCH	SCHNAPPVERSCHLUSS	SCROCCHETO
5	902023		1	DADO SCROCCHETTO	ECROU DE CLIQUET	NUT CATCH	KLIKENMUTTER	TUERCA
6	903651		1	CUSTODIA CON MAGNETE	PROTECTION MAGNETO	COVER MAGNET	MAGNETSCHUTZ	ESTUCHE CON IMÁN
7	903933		1	MANIGLIA	MANILLE	HANDLE	KLINKE	MANILLA
8	906730		1	PROFILO MANIGLIA	LISTEAU MANILLE	HANDLETRIM	KLINKE PROFIL	PERFIL MANILLA
9	901249		1	CERNIERA SX	CHARNIÈRE GAUCHE	LEFT HINGLE	LNK SCHARNIER	BISAGRA IZQUIERDA
10	901248		1	CERNIERA DX	CHARNIÈRE DROITE	RIGHT HINGLE	RCT SCHARNIER	BISAGRA DERECHA
11	908041		2	MOLLA	RESSORT	SPRING	SCHEIBE	RESORTE
12	904990		4	PIEDINO	PIED	RUBBER LEG	EINSTELLBARERSOCKE	PIÉ
13	904592		1	PANNELLO LATERALE DX	PANNEAU DROITE	RIGHT PANEL	RECHTE VERKLEIDUNG	PANEL DERECHO LATERAL
14	904593		1	PANNELLO LATERALE SX	PANNEAU GAUCHE	LEFT PANEL	LINKE VERKLEIDUNG	PANEL IZQUIERDO LATERAL
15	904597		1	PANNELLO POSTERIORE	PANNEAU POSTERIEUR	BACK PANEL	HINTERE VERKLEIDUNG	PANEL POSTERIOR
16	904589		1	PANNELLO SUPERIORE	PANNEAU SUPERIEUR	UPPER SIDE PANEL	OBERE VERKLEIDUNG	PANEL SUPERIOR
17	904595		1	PANNELLO INFERIORE	PANNEAU INFERIEUR	LOWER PANEL	UNTERE VERKLEIDUNG	PANEL INFERIOR
18	908146		2	GUARNIZIONE	JOINT	GASKET	DICHTUNG	GUARNICIÓN

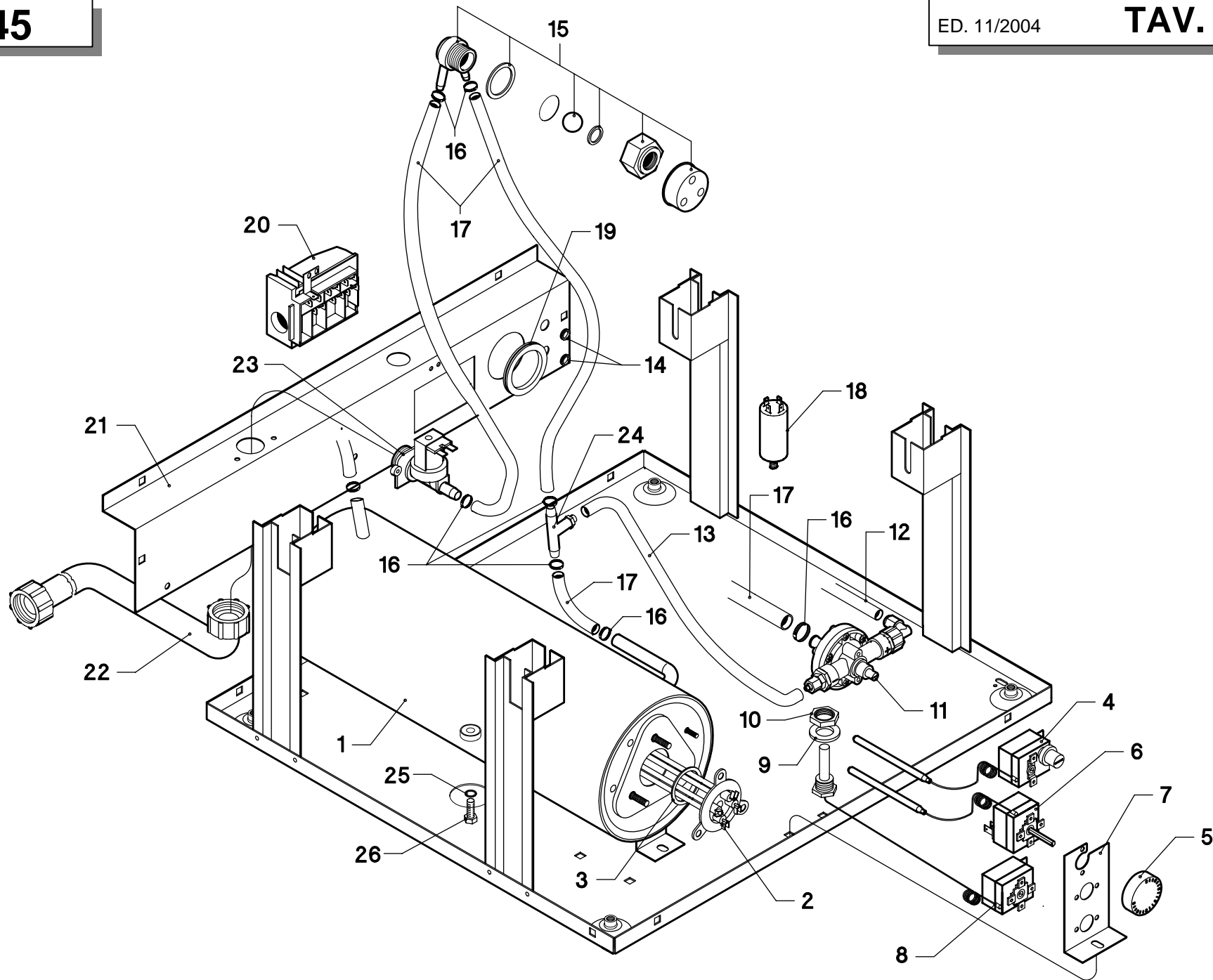

Pos.	COD.	COD.	Q.tà	DESCRIZIONE	DENOMINATION	DESCRIPTION	BEZEICHNUNG	DESCRIPCIÓN
1	900486		1	BOILER 4,5KW	CHAUFFE EAU	BOILER	HEISSWASSERSPEICHER	BOILER
2	905560		1	RESISTENZA 4,5KW	RESISTANCE	HEATINGELEMENT	HEIZKÖRPER	RESISTENCIA
3	907981		1	O-RING	O-RING	O-RING	O-RING	O-RING
4	907125		1	TERMOSTATO DI SICUREZZA	THERMOSTAT	THERMOSTAT	THERMOSTAT	TERMÓSTATO DE SEGURIDAD
5	903982		1	MANOPOLA	BOUTON	KNOB	KNOPF	EMPUÑADURA
6	TR0440		1	TERMOSTATO REG. 0° - 90°	THERMOSTAT	THERMOSTAT	THERMOSTAT	TERMÓSTATO
7	906367		1	SUPPORTO TERMOSTATI	SUPPORT THERMOSTAT	THERMOSTAT SUPPORT	THERMOSTATHALTER	SOPORTE TERMÓSTATO
8	907124		1	TERMOSTATO VASCA	THERMOSTAT	THERMOSTAT	THERMOSTAT	TERMÓSTATO PILETA
9	904991		1	GUARNIZIONE	JOINT	GASKET	DICHTUNG	GUARNICIÓN
10	902104		1	GHIERA 3/8" GAS	VIROLE	LOCK-NUT	NUT-MUTTER	DADO DE AJUSTE
11	902018		1	DOSATORE	DOSEUR	RINSE AID DISPENSER	DOSIERSATZ	DOSADOR
12	907278		1	TUBO 4X6 CRYSTAL TRASPARENTE	TUYAU CRISTAL	CRYSTAL PIPE	KRISTALLROHR	TUBO CRISTAL
13	907279		1	TUBO SILICONE 4 x 7	TUYAU DE SILICONE	SILICONE PIPE	SILIKONROHR	TUBO DE SILICONA
14	904723		2	PASSACAVO	CHAUMARD	FAIRLEAD	KABELDURCHGANG	AISLADOR
15	TR2433		1	VALVOLA ANTIRIFLUSSO	VALVE	VALVE	VENTIL	VALVULA
16	902440		5	FASCETTA 13 ÷ 20	COLLIER	CLAMP	SHELLE	ABRAZADERA
17	907295		4	TUBO GOMMA 12 x 19,5	TUYAU EN CAOUTCHOUC	RUBBER HOSE	GUMMISCHLAUCH	TUBO GOMA
18	901740		1	CONDENSATORE 12,5µF	CONDENSEUR	CONDENSER	KONDENSATEUR	CONDENSADOR
19	904721		1	PASSACAVO	CHAUMARD	FAIRLEAD	KABELDURCHGANG	AISLADOR
20	904150		1	MORSETTIERA	BORNES	TERMINAL BOARD	KLEMMLEISTE	TABLEROS DE BORNES
21	903447		1	SUPPORTO ELETTROVALVOLA	PALIER SOUPAPE ELECTRIQUE	BEARING ELECTRIC VALVE	TRÄGE ELEKTROVENTIL	SOPORTO VALVULA ELECTRICA
22	907344		1	TUBO DI CARICO	TUYAU D'ENTREE DE L'EAU	INLETPipe	WASSERZUFÜHRROHR	TUBO
23	902390		1	ELETTROVALVOLA 1 VIA	SOUPAPE ELECTRIQUE	ELECTRICVALVE	ELEKTROVENTIL	VALVULA ELECTRICA
24	905408		1	RACCORDO A "T"	RACCORD	PIPEFITTING	ANSCHLUSSE	EMPALME
25	904430		1	O-RING	O-RING	O-RING	O-RING	O-RING
26	907820		1	VITE T.E. M8x12	VIS	SCREW	SCHRAUBE	TORNILLO

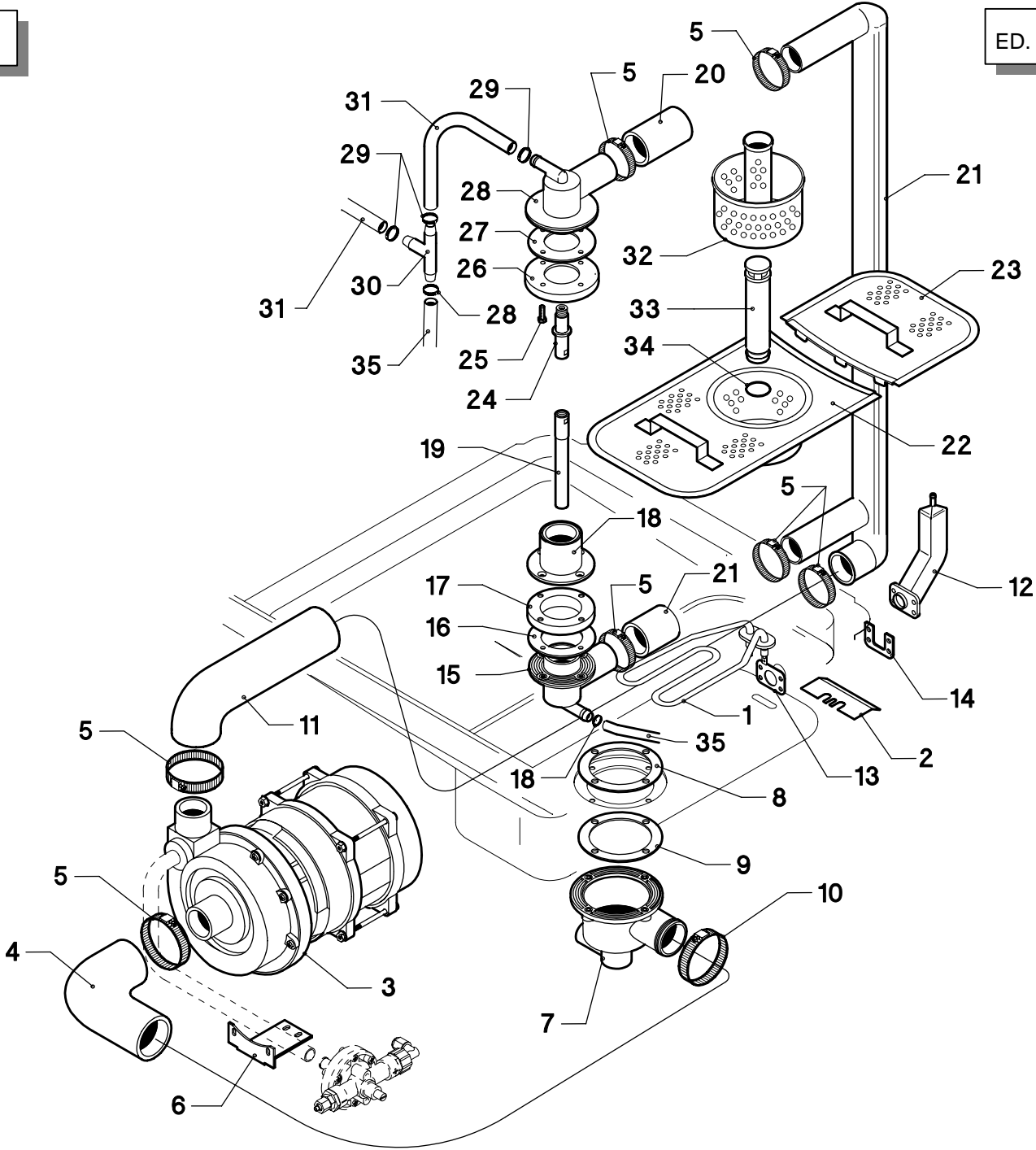

Pos.	COD.	COD.	Q.tà	DESCRIZIONE	DENOMINATION	DESCRIPTION	BEZEICHNUNG	DESCRIPCIÓN
1	905858		1	RESISTENZA 2000W	RESISTANCE	HEATINGELEMENT	HEIZKÖRPER	RESISTENCIA
2	904957		1	PROTEZIONE RESISTENZA	PROTECTION RESISTANCE	HEATINGELEMENT PROTECTION	HEIZKÖRPER SCHUTZ	PROTECCION RESISTENCIA
3	902293		1	POMPA 0,75 HP	POMPE	PUMP	PUMPE	BOMBA
4	908155		1	MANICOTTO ASPIRAZIONE	MANCHON D'ASPIRATION	INTAKE PIPE FITTING	ANSAUGANSCHLUSSE	PALANCA DE ASPIRACIÓN
5	902441		7	FASCETTA 38 ÷ 50	COLLIER	CLAMP	SHELLE	ABRAZADERA
6	906355		1	SUPPORTO POMPA	SUPPORT POMPE	PUMP SUPPORT	PUMPE TERUNG	SOPORTE BOMBA
7	905255		1	POZZETTO	PUISARD	SUMP	SCHACHT	POZUELO
8	905256		1	FLANGIA	VIS	SCREW	SCHRAUBE	SOPORTE
9	905257		1	GUARNIZIONE	JOINT	GASKET	DICHTUNG	GUARNICIÓN
10	902460		1	FASCETTA 26 ÷ 38	COLLIER	CLAMP	SHELLE	ABRAZADERA
11	908156		1	MANICOTTO MANDATA	TUYAU DE DÉCHARGÉ	OUTLETPipe	ABLAUF SCHLAUCH	TUBO DESAGOTE
12	907254		1	TRAPPOLA ARIA	RESERVOIR AIR	AIR TRAP	LUFTFALLE	TRAMPA DEL AIRE
13	903261		1	GUARNIZIONE	JOINT	GASKET	DICHTUNG	GUARNICIÓN
14	907926		1	PIASTRINA TRAPPOLA	PLAQUE PIEGE	TRAP PLATE	PLATTE MIT FANGSTELLE	CHAPA TRAMPA
15	905456		1	MOZZO LAVAGGIO/RISCIACQUO	MOYEU DE LAVAGE/RINÇAGE	WASHING/RINSE HUB	SPÜLUNG/NASCHSPÜLUNG NABE	BUJE DE LAVADO/ENJUAGUE
16	908141		1	GUARNIZIONE	JOINT	GASKET	DICHTUNG	GUARNICIÓN
17	902183		1	DISTANZIALE	ENTRETOISE	SPACER	ENTFERNUNGSSTÜCK	DISTANCIADOR
18	905388		1	RACCORDO INFER. LAVAGGIO	RACCORD DE LAVAGE INFER.	WASHING INFER. PIPE FITTING	UNTERANSCHLUSS WASCHEN	EMPALME INFER. DE LAVADO
19	908143		1	PERNO RISCIACQUO INFERIORE	TOURILLON DE RINÇAGE INFER.	INFERIOR RINSE PIN	UNTERS PÜLLSTIFT	PERNO ENJUAGUE INFERIOR
20	903756		2	TUBO GIUNZIONE	TUYAU	PIPE	SCHLAUCH	TUBO
21	903744		1	TUBO MANDATA SUPERIORE	TUYAU DE REFOUL. SUPERIEUR	UPPER OUTLET PIPE	OBERAUSLASSROHR	TUBO DE MANDO SUPERIOR
22	906700		1	FILTRO ANTERIORE	FILTRE ANTÉRIEUR	FRONT FILTER	VORDERER FILTER	FILTRO DELANTERO
23	906701		1	FILTRO POSTERIORE	FILTRE POSTERIEUR	BACK FILTER	HINTERE FILTER	FILTRO POSTERIOR
24	904799		1	PERNO RISCIACQUO	TOURILLON DE RINÇAGE	RINSE PIN	SPÜLLSTIFT	PERNO ENJUAGUE
25	907869		4	VITE M5x12	VIS	SCREW	SCHRAUBE	TORNILLO
26	908124		1	FLANGIA	FLASQUE	FLANGE	FLANSCH	SOPORTE
27	908141		1	GUARNIZIONE	JOINT	GASKET	DICHTUNG	GUARNICIÓN
28	905449		1	MOZZO SUPERIORE SX	MOYEU SUPERIEUR SX	UPPER HUB SX	OBERNABE SX	BUJE SUPERIOR SX
29	902440		4	FASCETTA 13 ÷ 20	COLLIER	CLAMP	SHELLE	ABRAZADERA
30	905382		1	RACCORDO A "T"	RACCORD	PIPEFITTING	ANSCHLUSSE	EMPALME
31	907295		2	TUBO GOMMA 12 x 19,5	TUYAU EN CAOUTCHOUC	RUBBER HOSE	GUMMISCHLAUCH	TUBO GOMA
32	904469		1	FILTRO	FILTRE	FILTER	FILTER	FILTRO
33	907303		1	TROPPO PIENO	NIVEAU	OVER FLOW	VEBERLAUF	DAMISIADO LLENO
34	904404		1	O-RING	O-RING	O-RING	O-RING	O-RING
35	907295		1	TUBO GOMMA 12 x 19,5	TUYAU EN CAOUTCHOUC	RUBBER HOSE	GUMMISCHLAUCH	TUBO GOMA

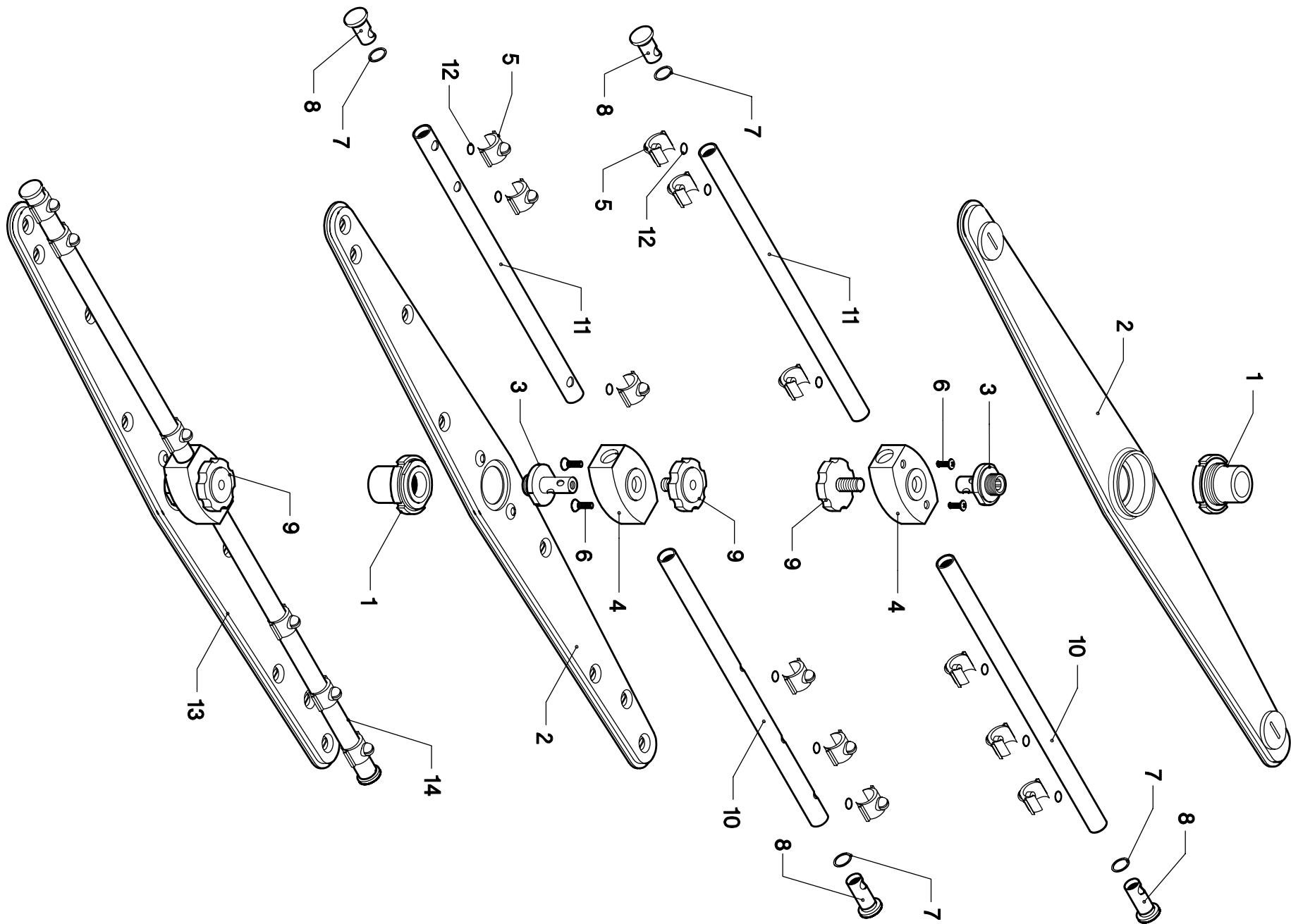

N45

ED. 11/2004

TAV. 4

<i>Pos.</i>	<i>COD.</i>	<i>COD.</i>	<i>Q.tà</i>	<i>DESCRIZIONE</i>	<i>DENOMINATION</i>	<i>DESCRIPTION</i>	<i>BEZEICHNUNG</i>	<i>DESCRIPCIÓN</i>
1	904277		2	MOZZO + GHIERA	MOYEU + VIROLE	HUB + RING - NUT	NABE + KLEMMUTTER	BUJE + ABRAZADERA
2	902908		2	GIRANTE LAVAGGIO	BRAS DE LAVAGE	WASH ARM	SPÜLLARM	RODETE LAVADO
3	904760		2	PERNO GIRANTE RISC.	TOURILLON DE RINÇAGE	RINSE PIN	SPÜLLSTIFT	PERNO RODETE ENJUAGUE
4	904292		2	MOZZO GIRANTE RISC.	MOYEU	HUB	NABE	BUJE RODETE ENJUAGUE
5	902816		12	GETTO RISCIAQUO	JET DE RINÇAGE	RINSING JET	SPÜLLDUSE	CHORRO ENJUAGUE
6	907651		4	VITE TPS M 4x8	VIS	SCREW	SCHRAUBE	TORNILLO
7	904321		4	O - RING	O - RING	O - RING	O - RING	O-RING
8	906450		4	TAPPO PER BRACCIO RISC.	BOUCHON BRAS DE RINÇAGE	PLUG FOR RINSE ARM	VERSCHLUSS SPÜLLAUF.	TAPÓN PARA BRAZO ENJUAGUE
9	902880		2	GHIERA BLOCCAGGIO	FRETTE DE BLOCAGE	RING -NUT	KLEMMUTTER	ABRAZADERA BLOQUEO
10	954804		2	BRACCIO RISCIAQUO DX	BRAS DE RINÇAGE DROITE	RIGHT RINSE ARM	RECHTE SPÜLLAUFRAD	BRAZO ENJUAGUE DERECHO
11	954805		2	BRACCIO RISCIAQUO SX	BRAS DE RINÇAGE GAUCHE	LEFT RINSE ARM	LINKE SPÜLLAUFRAD	BRAZO ENJUAGUE IZQUIERDO
12	904388		12	O - RING	O - RING	O - RING	O - RING	O-RING
13	903106		2	GIRANTE LAVAGGIO COMP.	BRAS DE LAVAGE	WASH ARM	SPÜLLARM	RODETE LAVADO COMPL.
14	903016		2	GIRANTE RISCIAQUO COMP.	BRAS DE RINÇAGE.	SWILLARM	SPÜLLSTIFT	RODETE ENJUAGUE COMP.

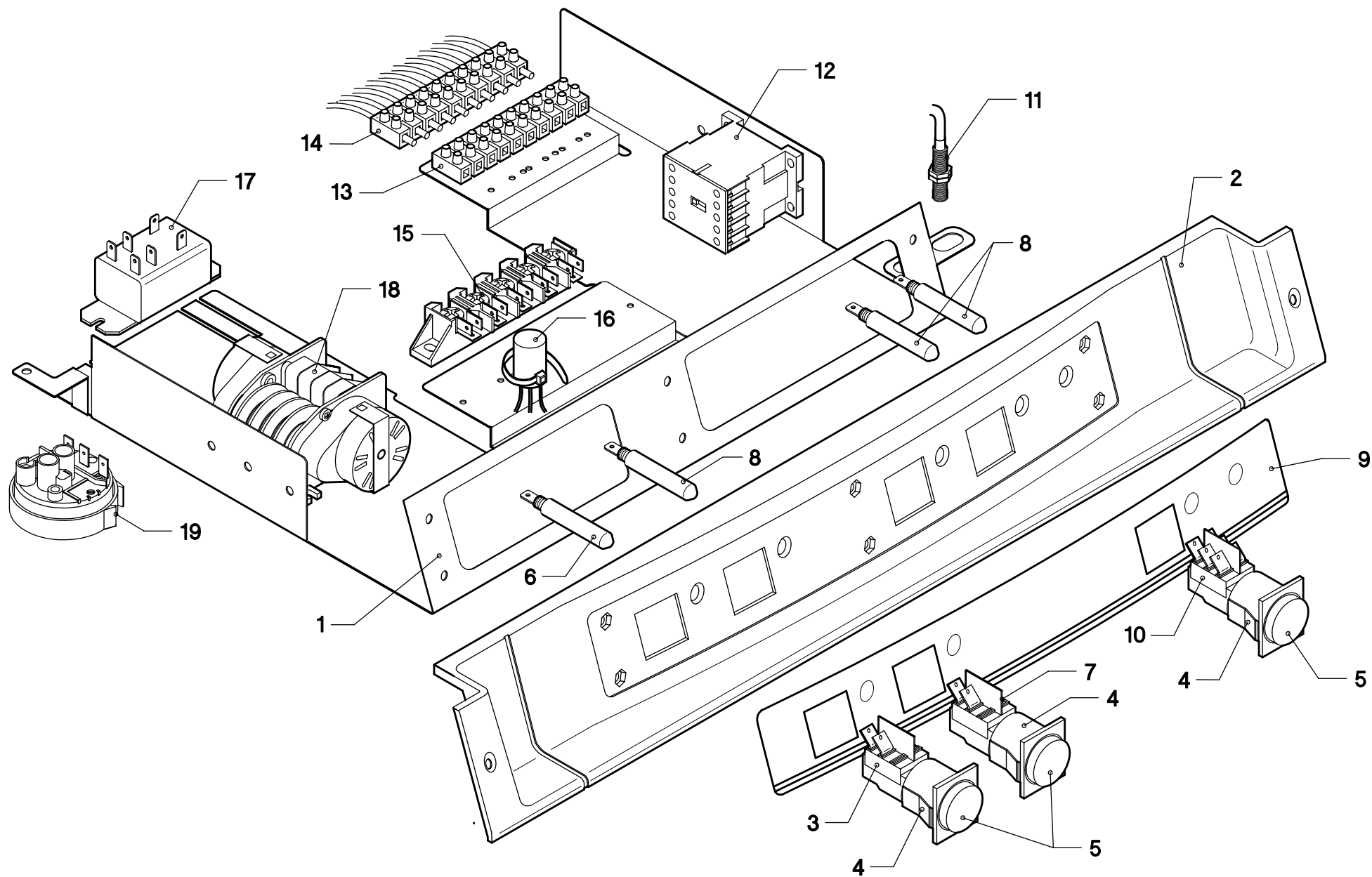

Pos.	COD.	COD.	Q.tà	DESCRIZIONE	DENOMINATION	DESCRIPTION	BEZEICHNUNG	DESCRIPCIÓN
1	955318		1	PIASTRA PORTACOMPONENTI	PLAQUE COMPOSANTS	COMPONENT PLATE	PLATTE ZUSAMMENSETZEND	PLACA COMPONENTES
2	903984		1	TARGA	PLAQUETTE	PLATE	SCHILD	PLACA
3	905318		1	INTERRUTTORE LINEA	INTERRUPTEUR DE LIGNE	LINE SWITCH	DRUCKKNOPFVORB.	INTERRUPTOR
4	905307		3	SUPPORTO TASTO	SUPPORT BOUTON	SUPPORT KEY	TASTEHALTER	SOPORTE TECLA
5	905305		3	TASTO TONDO GIALLO	BOUTON JAUNE	YELLOW PUSH-BUTTON	GELBE DRUCKTASTE	BOTÓN AMARILLO
6	903633		1	LAMPADA SPIA VERDE	LAMPE	LAMP	KONTROLLAMPE	LÁMPARA
7	905312		1	PULSANTE 2 FASTON	BOUTON	PUSH-BUTTON	DRUCKTASTE	BOTÓN
8	903645		3	LAMPADA SPIA ARANCIO	LAMPE	LAMP	KONTROLLAMPE	LÁMPARA
9	907059		1	TARGA	PLAQUETTE	PLATE	SCHILD	PLACA
10	905314		1	INTERRUT. SELETT. TEMPI	INTERRUPT.SELECT.TEMPS	TIME SELECTORSWITCH	WAHLSCHALTER	INTER. SELECCIONADOR TIEMPO
11	TR0309		1	REED MAGNETICO	REED	REED	REED	REED MAGNÉTICO
12	907095		1	TELERUTTORE	TELERUPTEUR	CONTACTOR	SCHUTZ	TELERRUPTOR
13	904170		1	MORSETTIERE 10 POLI	BORNES	TERMINALBOARD	KLEMMLEISTE	TABLEROS DE BORNES
14	904200		1	MORSETTIERE 10 POLI	BORNES	TERMINALBOARD	KLEMMLEISTE	TABLEROS DE BORNES
15	904150		1	MORSETTIERE	BORNES	TERMINALBOARD	KLEMMLEISTE	TABLEROS DE BORNES
16	902107		1	FILTRI ANTIDISTURBO TRIFASE	FILTRE ANTIDERANGEMENT	NOISE FILTER	ENTSTORFILTER	FILTROS DE RUIDOSIDAD
17	905486		1	RELE'	RELAIS	RELAY	RELAIS	RELE'
18	907182		1	TYMER CICLO	TYMER CYCLE	CYCLE TYMER	ZYCLUSZEITUHR	TYMER CICLO
19	905275		1	PRESSOSTATO 35/90	PRESSOSTAT	PRESSURE SWITCH	DRUCHWAECHTE	PRESOSTATO