



ISO 9001
BUREAU VERITAS
Certification



ISO 14001
BUREAU VERITAS
Certification



Applus®
LGAI
Organismo
Notificado
0370

AENOR
Organismo
Notificado
0099

FUNDADA EN 1878
MASBAGA
GRANDES COCINAS

EURAST

mac-fin

TOLERANCIAS GENERALES: ±0.5 mm

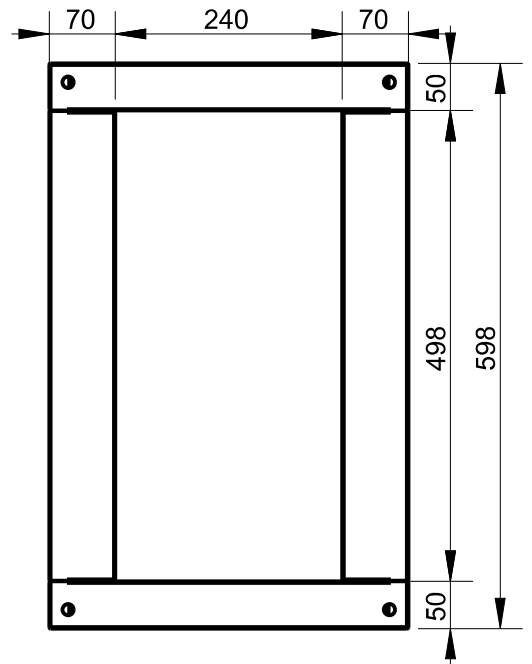
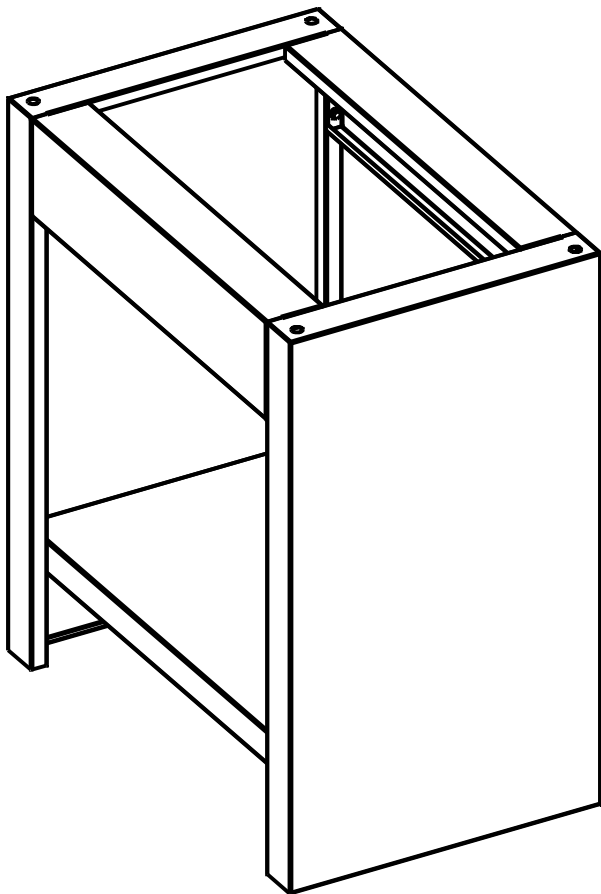
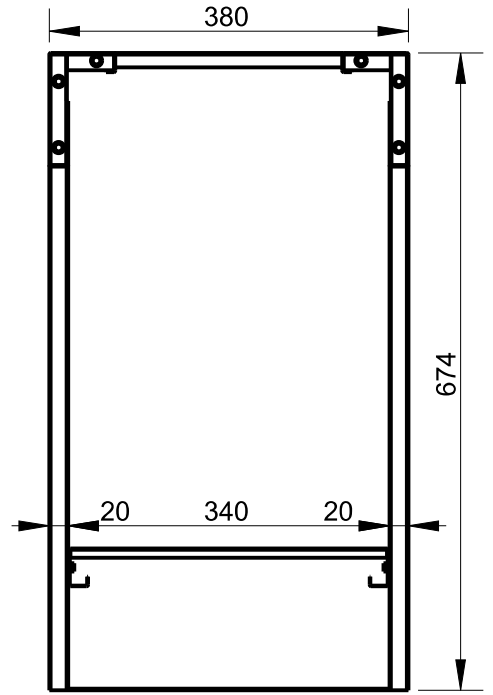
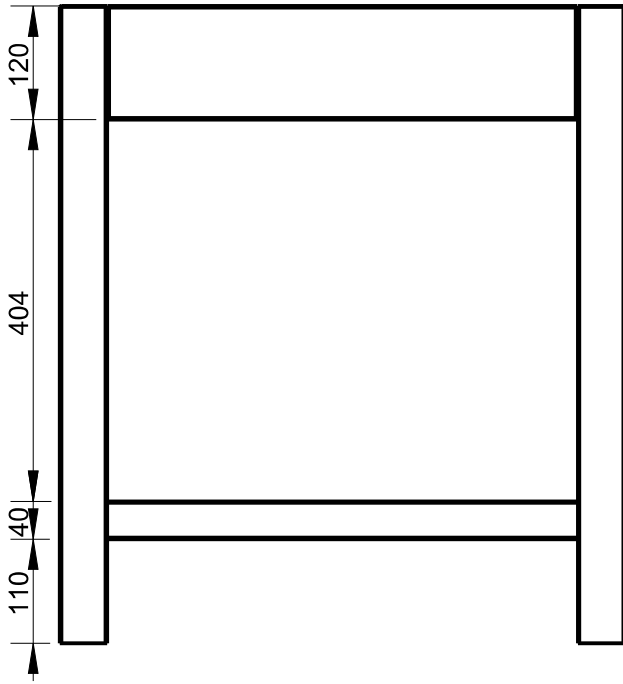

FAMILIA: BAR 2009

FECHA: 10/05/10

MODELO: 4490

PESO(Kg): 8.299

DENOMINACION:
MESA SOPORTE BAR L.600

ESCALA:
1/8

MATERIAL:
INOX

CODIGO:
4490



Applus®
LGA1
Organismo
Notificado
0370

AENOR
Organismo
Notificado
0099



TOLERANCIAS GENERALES: ±0.5 mm

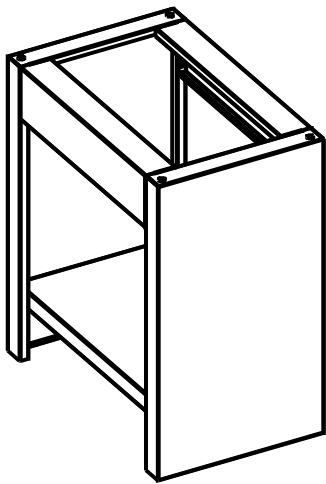

QT	COD	DESCRIPCION
2	449008	LATERAL SOPORTE BAR
1	449035	ESTANTE SOPORTE BAR 600
2	449065	FRISO SOPORTE BAR 600
16	C1062003	TORNILLO M-5X15 DIN933 ZN
16	C1260053	ARANDELA M-5 DIN-125 ZN

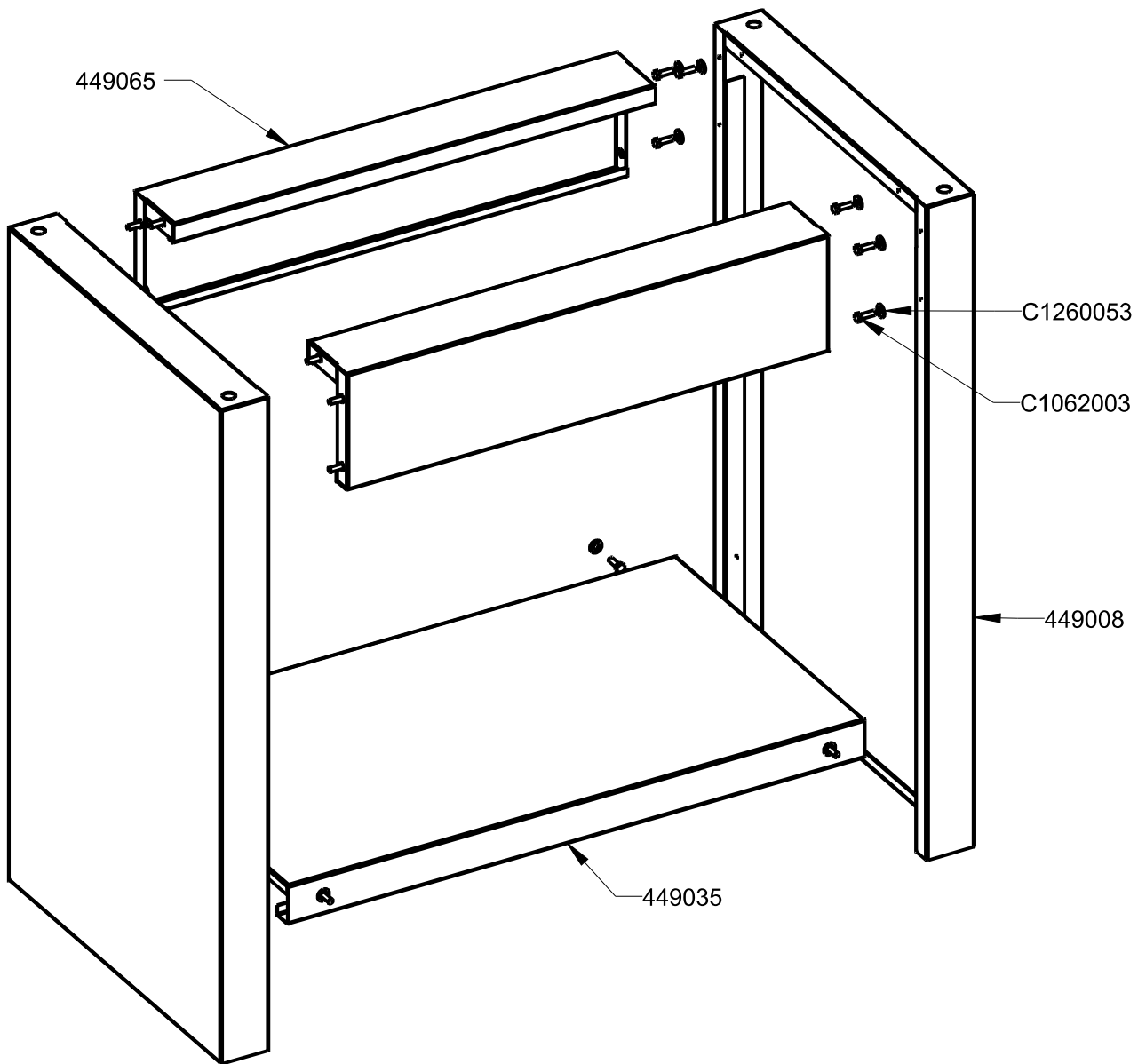

FAMILIA: BAR 2009

FECHA: 10/05/10

MODELO: 4490

PESO(Kg): 8.299

DENOMINACION:
MESA SOPORTE BAR L.600

ESCALA:
1/6

MATERIAL:
INOX

CODIGO:
4490



Applus[®]
LGA1
Organismo
Notificado
0370

AENOR
Organismo
Notificado
0099



TOLERANCIAS GENERALES: ±0.5 mm

QT	COD	DESCRIPCION	FAB.	MATERIAL	DATA	PESO
1	4490	MESA SOPORTE BAR L.600	SÍ	INOX	10/05/10	8.299
2	449008	LATERAL SOPORTE BAR	SÍ	INOFER 0.8	10/05/10	2.471
1	449035	ESTANTE SOPORTE BAR 600	SÍ	INOFER 0.8	10/05/10	1.781
2	449065	FRISO SOPORTE BAR 600	SÍ	INOFER 0.8	10/05/10	0.788
16	C1062003	TORNILLO M-5X15 DIN933 ZN	NO	FE ZN	03/02/09	0.003
16	C1260053	ARANDELA M-5 DIN-125 ZN	NO	FE ZN	11/05/10	0.001



FAMILIA: BAR 2009

FECHA: 10/05/10

MODELO: 4490

PESO(Kg): 8.299

DENOMINACION:
MESA SOPORTE BAR L.600

ESCALA:
1/8

MATERIAL:
INOX

CODIGO:
4490