



## **Kühlung Tiefkühl-Deckenaggregat**

Artikel-Nr.  
666026 (SVK1170)

---

### **Explosionszeichnung / Ersatzteile**

---

Bitte bei Ersatzteilbestellung immer Artikelnummer und  
Seriennummer mit angeben!



SV1

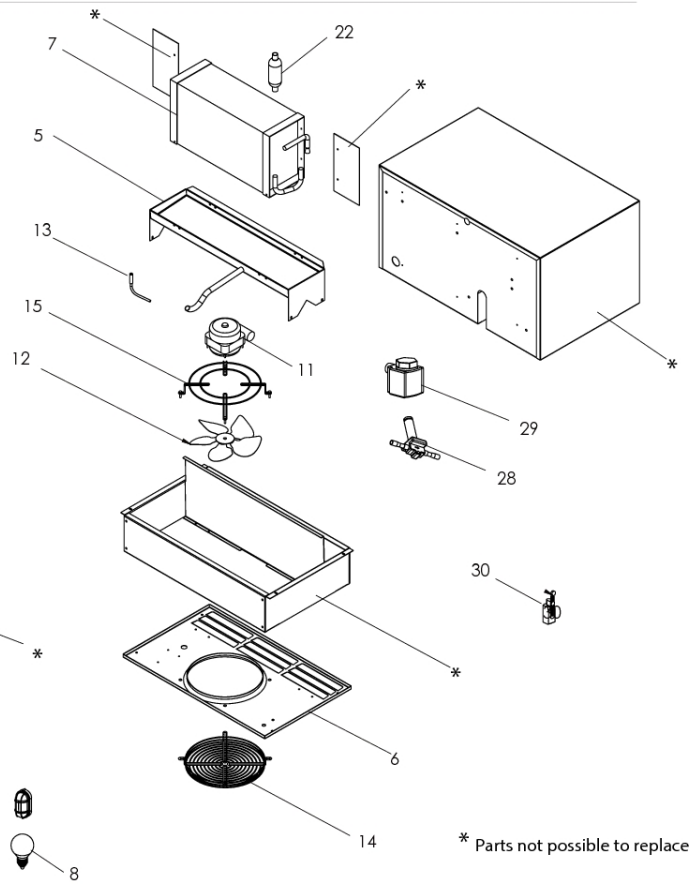
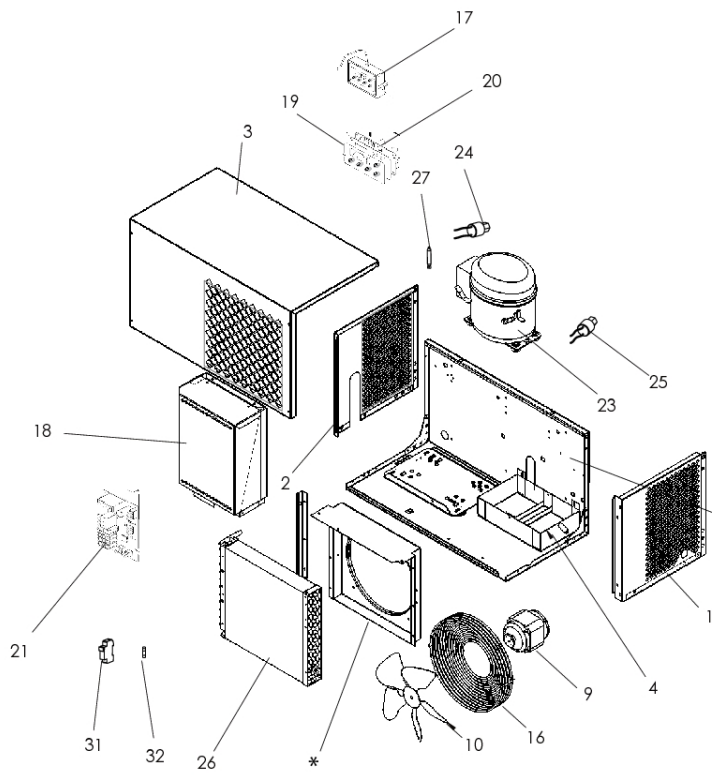

\* Parts not possible to replace

## SVK1170A2202\_B

Pos.	Code	Description	Qta	UM	Note
1	2600021K	CONDENSER RIGHT SIDE	1		
2	2600022K	CONDENSER LEFT SIDE	1		
3	2600023K	FRONTAL PANEL	1		
4	2125056	CONDENSATE TRAY	1		
5	2125064	EVAPORATOR DRAIN TRAY	1		
6	2125091K	EVAPORATOR CONVEYER	1		
7	3EVP151	EVAPORATOR	1		
8	3LMP047	LAMP	1		
9	3MVN021	FAN MOTOR	1		
10	3VNT048	CONDENSER FAN BLADE	1		
11	3MVN023	FAN MOTOR	1		
12	3VNT046	EVAPORATOR FAN BLADE	1		
13	3SNS085	TEMPERATURE PROBE	2		
14	3GRI028	FAN GRILLE	1		
15	2GRI029	FAN MOUNTING BRACKET	1		SPARE PART NOT AVAILABLE. REPLACED BY 3GRI029
16	3GRI046	FAN GRILLE	1		
17	3PRM1311	REMOTE PANEL	1		
18	3QECSBN0298	ELECTRIC PANEL	1		
19	3PNP066	CONTROL PANEL FOIL	1		
20	3TST046	ELECTRONIC KEYBOARD	1		
21	3SCH173	CONTROL PANEL	1		
22	3ACL050	LIQUID SEPARATOR	1		
23	3CMP359	COMPRESSOR	1		
24	3PRS033	LOW PRESSURE SWITCH	1		
25	3PRS025	HIGH PRESSURE SWITCH	1		
26	3CND176	CONDENSER	1		
27	3FLT093	FILTER	1		

## SVK1170A2202\_B

Pos.	Code	Description	Qta	UM	Note
28	3VLS001	SOLENOID VALVE	1		
29	3CVS001	SOLENOID COIL	1		
30	3MCT014	DOOR MICROSWITCH	1		
31	3BSF050	FUSE HOLDER	1		
32	3FSB167	FUSE	1		
33	3VRP074	PRESSURE REGULATING VALVE	1		