

GN3/1

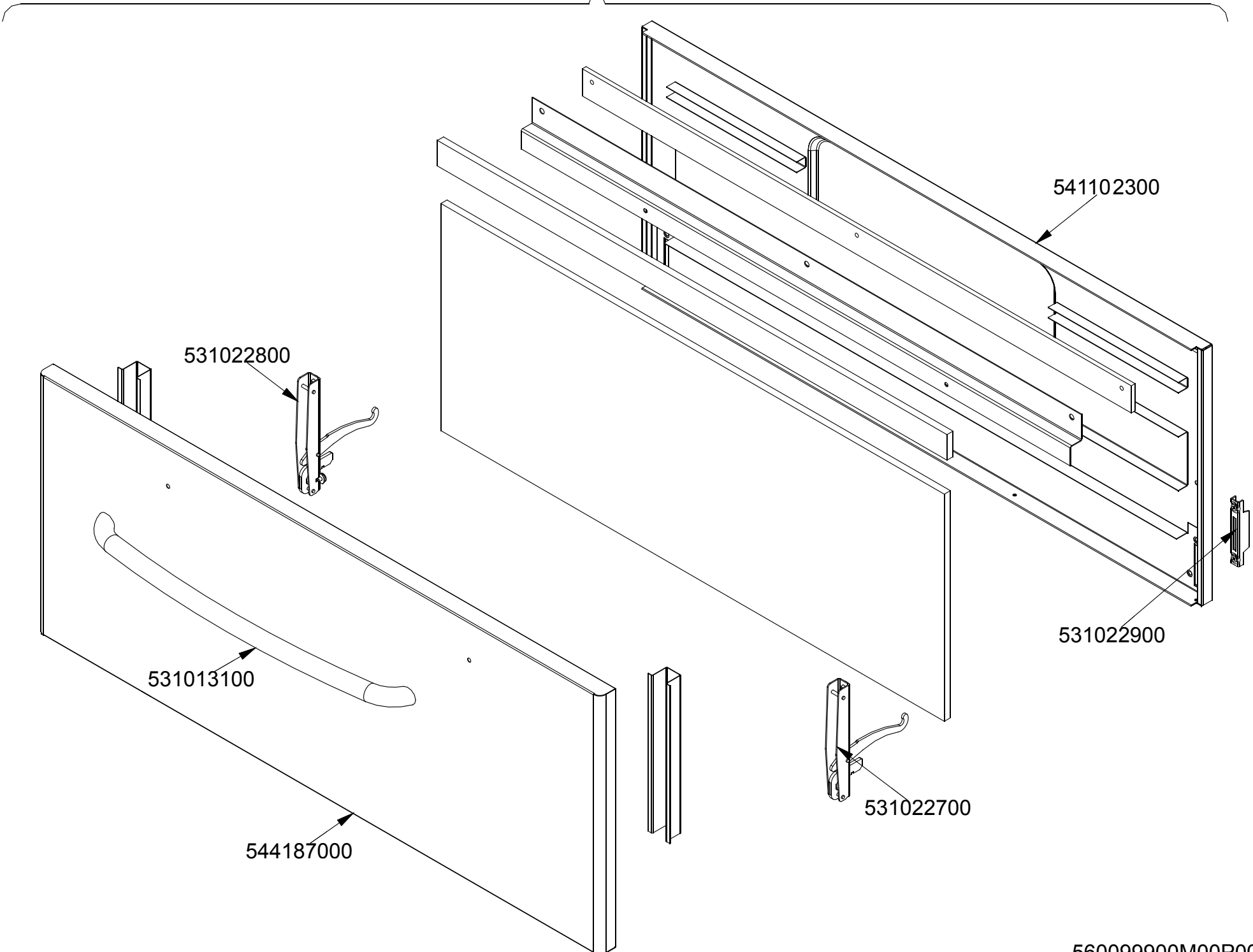

560099900M00P00

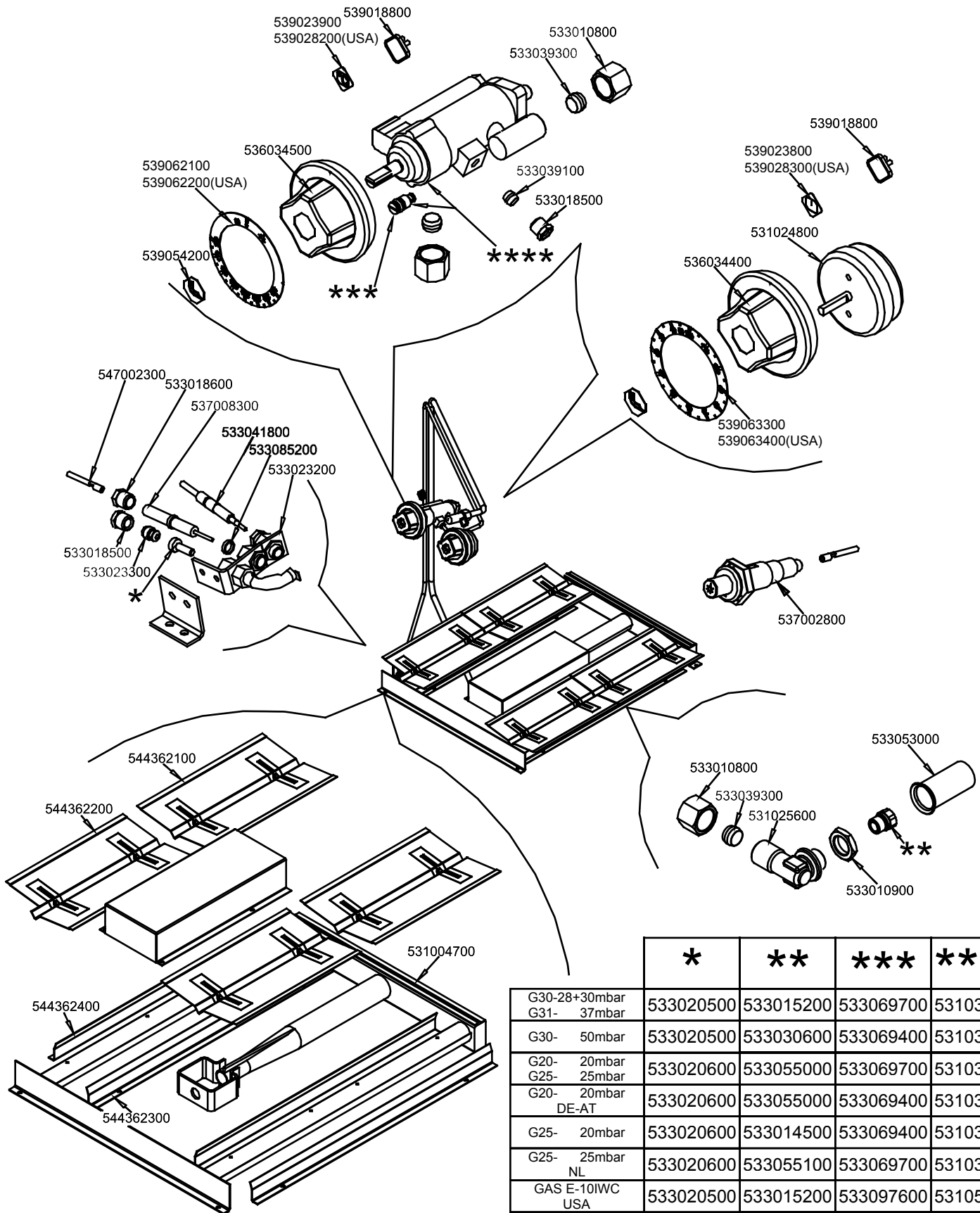

	*	**	***	****
G30-28+30mbar G31- 37mbar	533020500	533015200	533069700	531031600
G30- 50mbar	533020500	533030600	533069400	531033800
G20- 20mbar G25- 25mbar	533020600	533055000	533069700	531031600
G20- 20mbar DE-AT	533020600	533055000	533069400	531033800
G25- 20mbar	533020600	533014500	533069400	531033800
G25- 25mbar NL	533020600	533055100	533069700	531031600
GAS E-10IWC USA	533020500	533015200	533097600	531052500
GAS A-4IWC USA	533020600	533056300	533097600	531052500
G31- 2.49kPa AUS	533020500	533015200	533069700	531031600
G20- 1kPa AUS	533020700	533056300	533069700	531031600

533033800

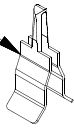

536010801



531030500  
531062300(USA-AUS)

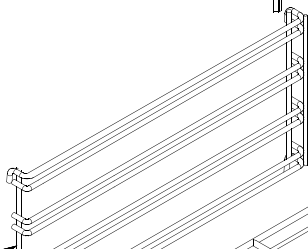

531030200  
531062000(USA-AUS)

544171700

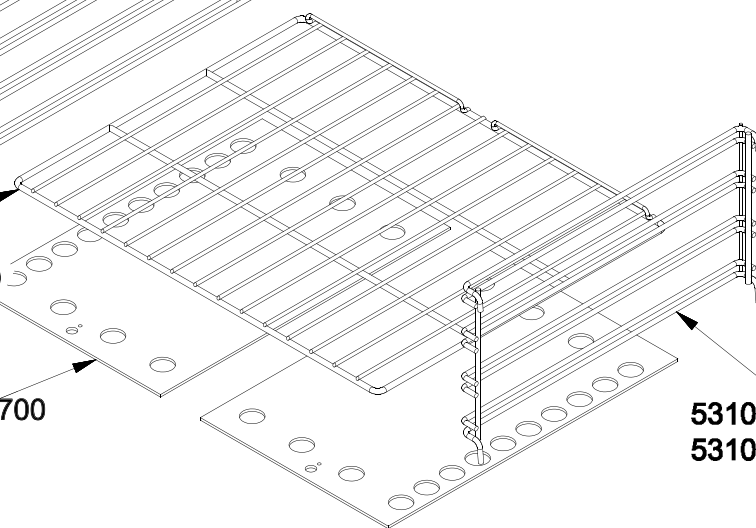

531030400  
531062200(USA-AUS)

560012300M02P00



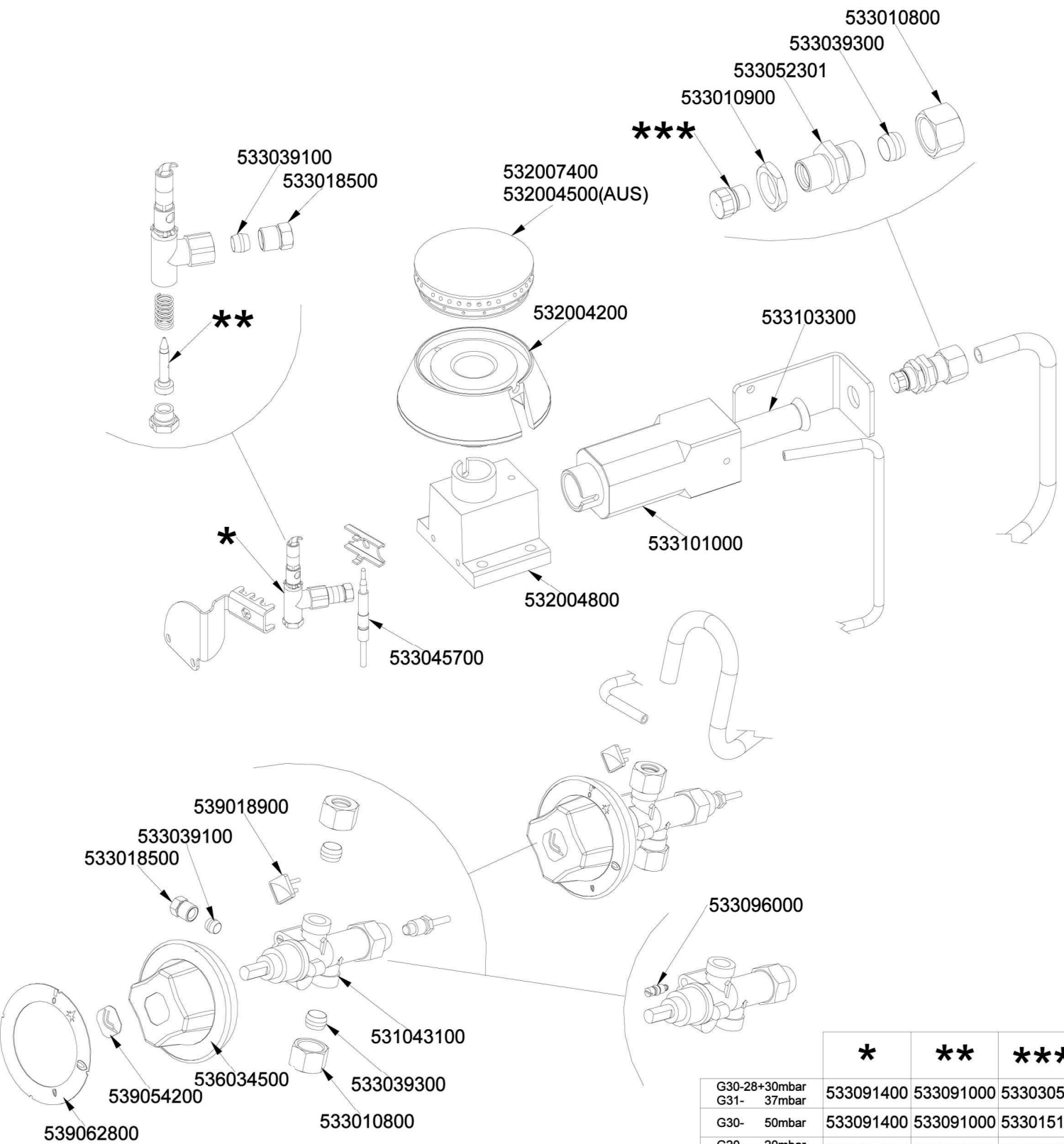

	*	**	***
G30-28+30mbar G31- 37mbar	533091400	533091000	533030500
G30- 50mbar	533091400	533091000	533015100
G20- 20mbar G25- 25mbar	533091500	533091200	533015200
G20- 20mbar DE-AT	533091500	533091200	533015200
G25- 20mbar	533091500	533091200	533030800
G25- 25mbar NL	533091500	533091200	533014900
G31- 2,49kPa AUS	533091400	533091000	533019300
G20- 1kPa AUS	533161200	533091300	533030300

560038500M02P00

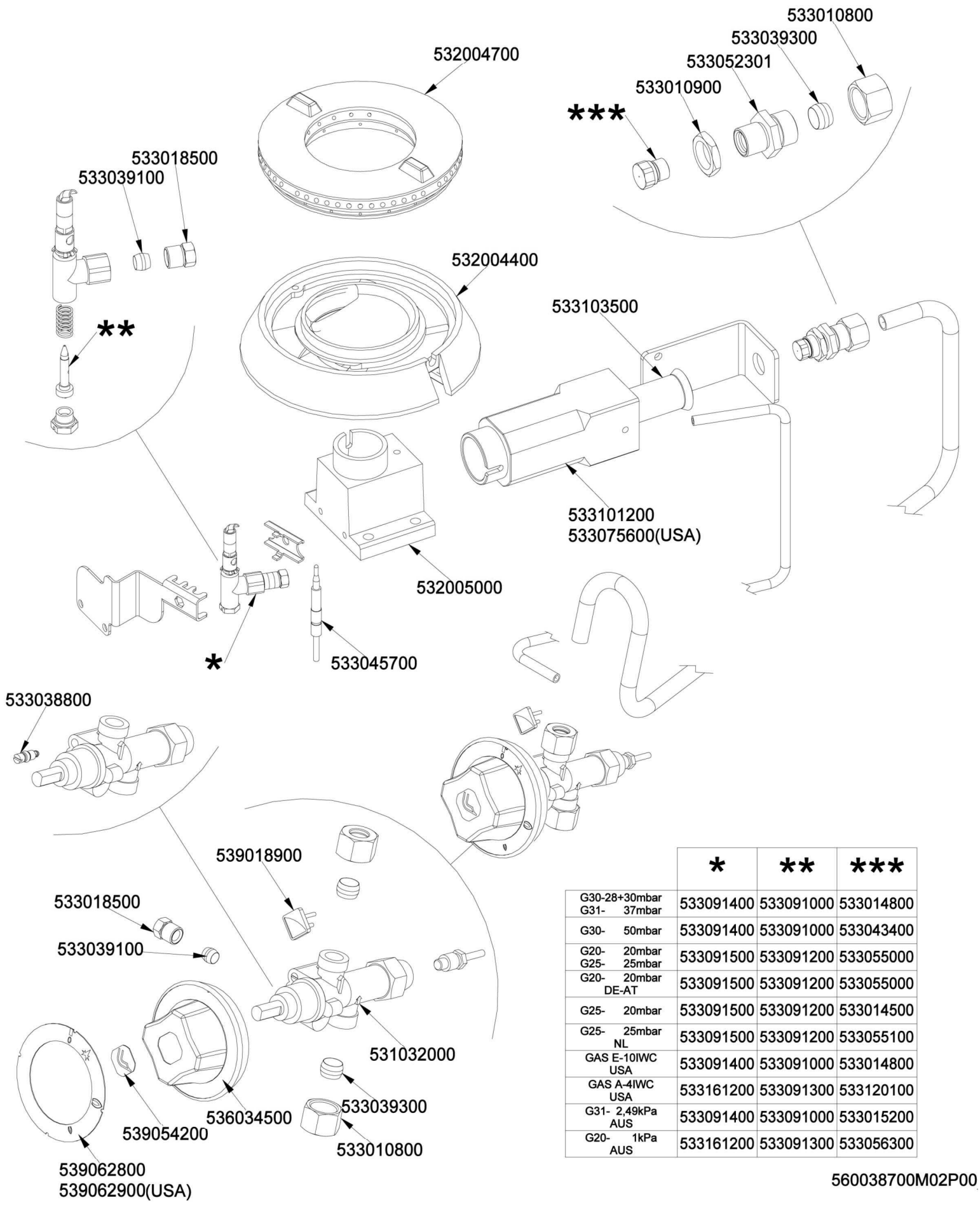

	<b>*</b>	<b>**</b>	<b>***</b>
G30-28+30mbar G31- 37mbar	533091400	533091000	533014800
G30- 50mbar	533091400	533091000	533043400
G20- 20mbar G25- 25mbar	533091500	533091200	533055000
G20- 20mbar DE-AT	533091500	533091200	533055000
G25- 20mbar	533091500	533091200	533014500
G25- 25mbar NL	533091500	533091200	533055100
GAS E-10IWC USA	533091400	533091000	533014800
GAS A-4IWC USA	533161200	533091300	533120100
G31- 2,49kPa AUS	533091400	533091000	533015200
G20- 1kPa AUS	533161200	533091300	533056300

560038700M02P00

Page	Pos	Code	Description
001		532004100	FLUE GRID L=370 90LINE (RAF
001		531047000	2 BURNER GRID FOR PC-700
001		541134400	LOW SPACER 78 1 GRID
001		544333900	BURNER CONTAINER 1/1GN R 304
001		544333800	BURNER CONTAINER 1/1GN R 304
001		544383200	UPPER PLATE PC-78GP CF4-78GP/GPE
001		544173300	LEFT SIDE PANEL RANGE S.70
001		541119600	FRONT PANEL CF4-98G
001		544173200	RIGHT SIDE PANEL RANGE S.70
001		536005200	INOX LEG 2" 120-180 M10
002		541102300	GAS OVEN INNER DOOR GN 3/1 S.70
002		531022800	LEFT OVEN DOOR HINGE S.70
002		531022900	HINGE DOOR WHEEL HOLDER S.70
002		531013100	OVEN DOOR HANDLE OF 70/90-LINE
002		531022700	RIGHT OVEN DOOR HINGE 70LINE
002		544187000	OVEN DOOR GN 3/1 S.70
003		539018800	BLANK INDEX FOR KNOB
003		539023900	SIGN PLATE FOR OVEN TEMPERATURE
003		539028200	SIGN PLATE FOR OVEN TEMPERATURE
003		533010800	TUBE NUT D.10 M16*1,5
003		533039300	BICONE §10
003		539023800	LABEL FOR OVEN TIMER
003		539028300	SIGN PLATE FOR OVEN TIMER
003		531024800	TIMER 120'- 360°
003		536034400	KNOB §77 4P. §06*4,6 C/M
003		533039100	BICONE §6
003		533018500	FITTING FOR BICONE D.6 M10*1
003		536034500	KNOB §77 4P. §08*6,5
003		539062100	ADESIVE DISK FOR GAS OVEN S70
003		539062200	ADESIVE DISK FOR GAS OVEN S70 USA
003		539054200	STAMP O20,5 CR."L" LOTUS R.
003		547002300	HIGH-VOLTAGE CABLE §2 L=1900
003		533018600	PLUG FITTING
003		537008300	ROUND PLUG §2,4- LONG ELECTRODE
003		533041800	THERMOCOUPLE 1500 M9*1
003		533085200	SPACER FOR PILOT PLUG
003		533023200	TARGET PILOT + NIPPLE TC BRAC.90°
003		539063300	ADESIVE DISK FOR TYMER GREY
003		539063400	ADESIVE DISK FOR TYMER GREY USA
003		533023300	BICONE §6 ("TARGET" PILOT
003		537002800	PIEZOELECTRIC IGNITION M18 WITH NUT
003		533053000	AIR ADJUSTMENT BUSHING §18
003		531025600	ELBOW 90° NOZZLE-HOLDER §10 PIPE
003		533010900	NUT M14*1 H.4
003		544362100	UPPER BURNER DEFLECTOR FOR OVEN 70
003		544362200	UPPER PILOT DEFLECTOR FOR OVEN 70
003		531004700	BURNER FOR OVEN GN 2/1 S.70
003		544362400	SIDE PILOT DEFLECTOR FOR OVEN 70
003		544362300	SIDE BURNER DEFLECTOR FOR OVEN 70
003		533020500	NOZZLE 0.140 §19
003		533020600	NOZZLE 0.140 §27



Page	Pos	Code	Description
003		533020700	NOZZLE 0.140 §35
003		533015200	NOZZLE §145 CH12*14 F-FP/CP6
003		533030600	NOZZLE §125 CH12*14
003		533055000	NOZZLE §205 CH12*14 G25 CW4
003		533014500	NOZZLE §225 CH12*14 OVEN GN 2/1
003		533055100	NOZZLE §215 CH12*14 L-CW4
003		533056300	NOZZLE §240 CH12*14
003		533069700	BY PASS COCK §075 25ST
003		533069400	BY PASS COCK §065 25ST
003		533097600	BY PASS COCK §090 25ST
003		531031600	HORIZON.THERMOSTATIC TAP BY-PASS 75
003		531033800	HORIZON.THERMOSTATIC TAP BYPASS §65
003		531052500	GAS COCK 25ST BY PASS D090 HORIZ.P
004		533033800	LOCK SPRING FOR BULB §6
004		536010801	OVEN GASKET GN 2/1 (1308
004		531030500	LHD SUPPORT GRID FOR OVEN OF 70LINE
004		531062300	LHD SUPPORT GRID FOR OVEN OF 70LINE
004		531030200	OVEN GRID GN 2/1 FOR 70 LINE
004		531062000	OVEN GRID GN 2/1 FOR 70 LINE
004		544171700	BOTTOM FOR GAS OVEN GN2/1 700LINE
004		531030400	RHD SUPPORT GRID FOR OVEN OF 70LINE
004		531062200	RHD SUPPORT GRID FOR OVEN OF 70LINE
005		532004600	BURNER COVER RING R D104
005		533039100	BICONE §6
005		533018500	FITTING FOR BICONE D.6 M10*1
005		532004300	MIDDLE BURNER BODY 70LINE P.
005		533010900	NUT M14*1 H.4
005		533052301	JOINT FOR NOZZLE HOLDER
005		533039300	BICONE §10
005		533010800	TUBE NUT D.10 M16*1,5
005		533045700	THERMOCOUPLE M9*1 500
005		533039400	THERMOCOUPLE M9*1*850
005		532004900	ELBOW FITTING OF BURNER VENTURI R
005		533069100	BY PASS COCK §60 20S
005		533101100	BURNER VENTURI R
005		533075500	BURNER VENTURI 5,5KW S70 USA
005		533103400	AIR ADJUSTMENT BUSHING D20 EST.H57
005		539018900	INDEX FOR KNOB W/RED SIGN
005		531042900	B.PASS §60 SAFETY COCK PC/CF 90
005		539054200	STAMP Ø20,5 CR."L" LOTUS R.
005		539062800	RED STICKING DISK 72
005		539062900	RED STICKING DISK 72 USA
005		533091400	P.NOZZLE S100 UG.§20 PC90 LPG-FLUS
005		533091500	PILOT NOZZLE S.100 §30 PC90 NAT.GAS
005		533091000	NOZZLE 0.100 §20
005		533091200	PILOT NOZZLE 0100 Ø35 PIL.PC
005		533091300	PILOT NOZZLE 0100 Ø40 PIL.PC
005		533043900	NOZZLE §115 CH12*14 F-CW4
005		533019300	NOZZLE §100 G-FQ5 F-CW
005		533031000	NOZZLE §175 CH12X14
005		533043500	NOZZLE §190 CH12*14 G25 PC4R

Page	Pos	Code	Description
005		533019400	NOZZLE §180 CH12*14 L-FQ5
005		533043200	NOZZLE §110 G30 (LPG) CH12X14
005		533043100	NOZZLE §185 G25 CH12X14
006		533010800	TUBE NUT D.10 M16*1,5
006		533039300	BICONE §10
006		533052301	JOINT FOR NOZZLE HOLDER
006		533010900	NUT M14*1 H.4
006		533039100	BICONE §6
006		532007400	BURNER COVER RING Ø073 4 Z
006		533018500	FITTING FOR BICONE D.6 M10*1
006		532004500	BURNER COVER RING SR D73
006		532004200	SMALL BURNER BODY 70LINE P.
006		533103300	AIR ADJUSTMENT BUSHING D16 EST.H57
006		533101000	BURNER VENTURI SR
006		532004800	ELBOW FITTING OF BURNER VENTURI SR
006		533045700	THERMOCOUPLE M9*1 500
006		539018900	INDEX FOR KNOB W/RED SIGN
006		533096000	§50 BY-PASS COCK 20S-21S
006		531043100	B.PASS §50 SAFETY COCK PC/CF 70
006		539054200	STAMP Ø20,5 CR."L" LOTUS R.
006		536034500	KNOB §77 4P. §08*6,5
006		539062800	RED STICKING DISK 72
006		533091400	P.NOZZLE S100 UG.§20 PC90 LPG-FLUS
006		533091500	PILOT NOZZLE S.100 §30 PC90 NAT.GAS
006		533091000	NOZZLE 0.100 §20
006		533091200	PILOT NOZZLE 0100 Ø35 PIL.PC
006		533091300	PILOT NOZZLE 0100 Ø40 PIL.PC
006		533030500	NOZZLE §90 CH12X14 G30/CE
006		533015100	NOZZLE §80 CH12*14 F-FP/CP6
006		533015200	NOZZLE §145 CH12*14 F-FP/CP6
006		533030800	NOZZLE §155 CH12X14 M-CW
006		533014900	NOZZLE §150 CH12*14 F-FQ5 L-FQ6
006		533019300	NOZZLE §100 G-FQ5 F-CW
006		533030300	NOZZLE §160 CH12*14 M-FPG
007		533010800	TUBE NUT D.10 M16*1,5
007		533039300	BICONE §10
007		533052301	JOINT FOR NOZZLE HOLDER
007		532004700	BURNER COVER RING UR D128
007		533010900	NUT M14*1 H.4
007		533018500	FITTING FOR BICONE D.6 M10*1
007		533039100	BICONE §6
007		532004400	BIG BURNER BODY 70LINE P.
007		533103500	AIR ADJUSTMENT BUSHING D22 EST.H57
007		533101200	BURNER VENTURI UR
007		533075600	BURNER VENTURI 7,5KW S70 USA
007		532005000	ELBOW FITTING OF BURNER VENTURI UR
007		533045700	THERMOCOUPLE M9*1 500
007		533038800	75 BY-PASS FOR 21S TAP
007		539018900	INDEX FOR KNOB W/RED SIGN
007		531032000	GAS COCK P.V.BY-PASS Ø075
007		536034500	KNOB §77 4P. §08*6,5

Page	Pos	Code	Description
007		539054200	STAMP Ø20,5 CR."L" LOTUS R.
007		539062800	RED STICKING DISK 72
007		539062900	RED STICKING DISK 72 USA
007		533091400	P.NOZZLE S100 UG.§20 PC90 LPG-FLUS
007		533091500	PILOT NOZZLE S.100 §30 PC90 NAT.GAS
007		533091000	NOZZLE 0.100 §20
007		533091200	PILOT NOZZLE 0100 Ø35 PIL.PC
007		533091300	PILOT NOZZLE 0100 Ø40 PIL.PC
007		533014800	NOZZLE §135 CH12*14,0
007		533043400	NOZZLE §117 CH12*14 G-PC4 UR
007		533055000	NOZZLE §205 CH12*14 G25 CW4
007		533014500	NOZZLE §225 CH12*14 OVEN GN 2/1
007		533055100	NOZZLE §215 CH12*14 L-CW4
007		533120100	NOZZLE §210 CH12*14,0
007		533015200	NOZZLE §145 CH12*14 F-FP/CP6
007		533056300	NOZZLE §240 CH12*14