

SUPERLOTUS 70 TOP

GAS / GAS / GAS / GAZ

FTT...-74G FTT...-76G FTT...-76G FTT...-78G

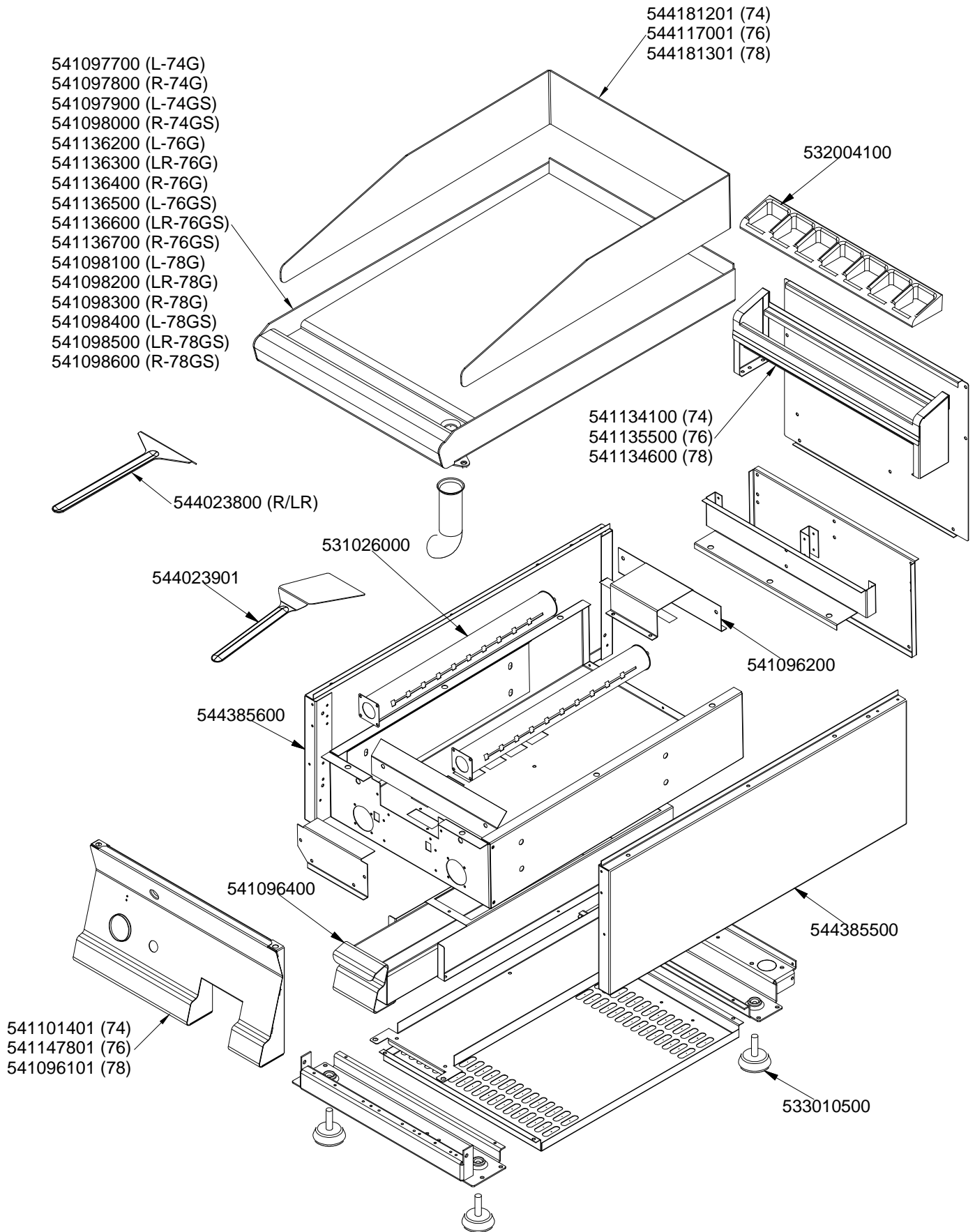

560039300M00P00

Page	Pos	Code	Description
001		541097900	UPPER PLATE FTL-74G
001		544181201	SPLASH GUARD FT-74
001		532004100	FLUE GRID L=370 70LINE (RAF)
001		541134100	LOW SPACER 74 1 GRID
001		531026000	BURNER FT-4/6/8G BM-4G
001		544023901	SPATTLE FOR FRY-TOP
001		541096200	BURNER SUPPORT FT-74G FT-78G
001		544385600	LEFT SIDE OF 70T LINE
001		541096400	DRIP TRAY FT S.70
001		544385500	RIGHT SIDE OF 70T LINE
001		533010500	LEG M10*25 D.40
001		541101401	CONTROL PANEL S70/90 FT-74G FT-94G