

539018900

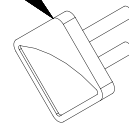

537013300

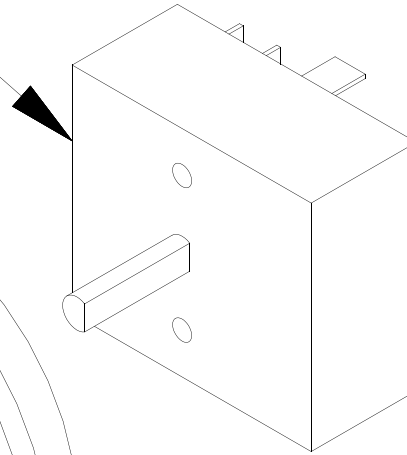

536034400

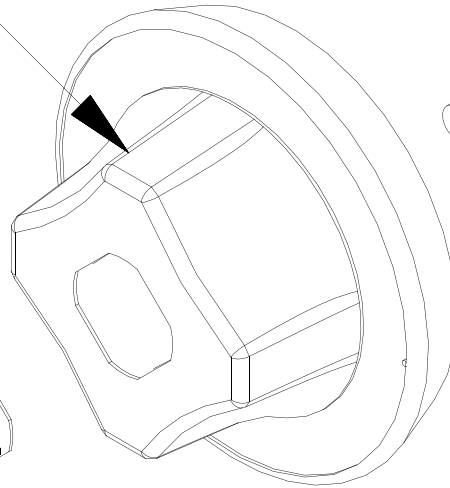

539054200

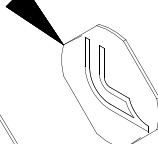

539060300

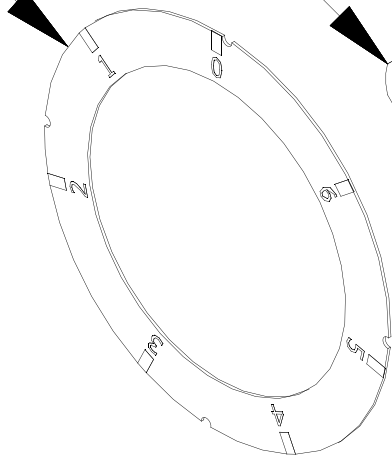

537014200

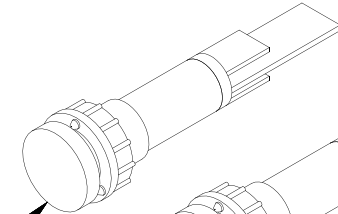

537014100

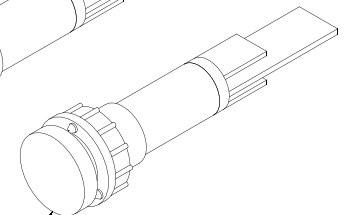

560110400M00P00

539018900

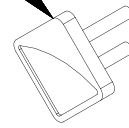

537013300

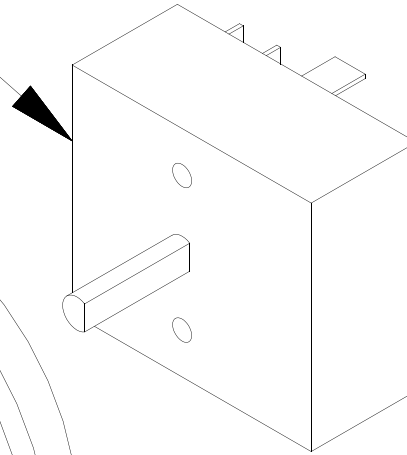

536034400

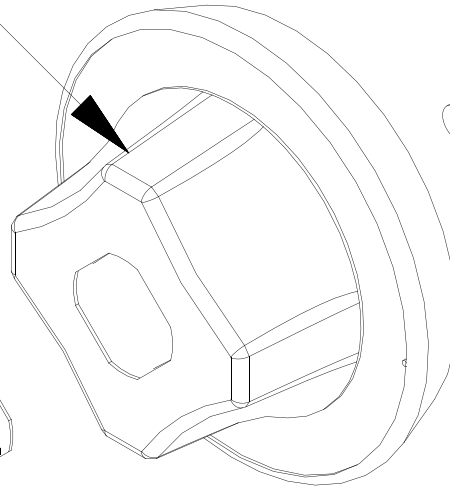

539054200

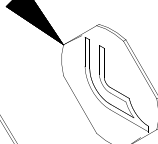

539060300

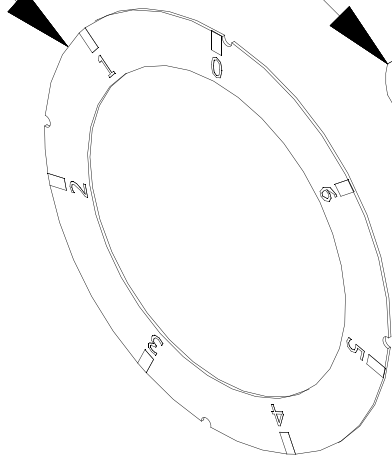

537014200

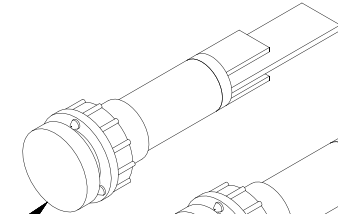

537014100

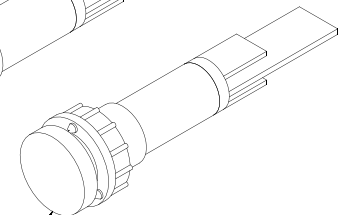

560110400M00P00

Page	Pos	Code	Description
001		541293700	COMPLETE HEAT.ELEMENT CWK74ET 4080W
001		536038700	GUARNIZIONE RESISTENZA CWK
001		533148700	IMPUGNATURA CWK
001		541134000	NEUTRAL LOW SPACER 74
001		544739600	
001		531042800	SEMISPHERE FILTER
001		541283401	ASS.PIANO S70 CWK-74ET
001		533010100	3/4 D. 18 PIPE UNION
001		533010200	BICONE 18S
001		531000100	DRAIN COCK 3/4"
001		544173500	LEFT SIDE PANEL S.70
001		533009600	DRAIN COCK HANDLE
001		536000300	FIXED GRIP D.15*25*M6
001		537027400	TERMINAL BLOCK THREEPHASE 40A
001		537010100	REMOTE CONTROL SWITCH 20A 230V
001		541139100	CONTROL PANEL S70/90 BMT-74/94E CP
001		544120300	DRAIN PIPE 22 FOR COCK 3/4"G
001		544173400	RIGHT SIDE PANEL S.70
001		536005200	INOX LEG 2" 120-180 M10
002		539018900	INDEX FOR KNOB W/RED SIGN
002		537013300	CURRENT REGULATOR FOR ELEC. PLATE
002		536034400	KNOB §77 4P. §06*4,6 C/M
002		539054200	STAMP Ø20,5 CR."L" LOTUS R.
002		539060300	RED ADESIVE DISK FOR PCC/PCI-E
002		537014200	GREEN WARNING LIGHT 250V
002		537014100	WHITE WARNING LIGHT 250V