

IPERLOTUS 90 TOP
ELETTRICO / ELECTRIC / ELEKTRO / ELECTRIQUE

FTCT-94ET FTCT-98ET

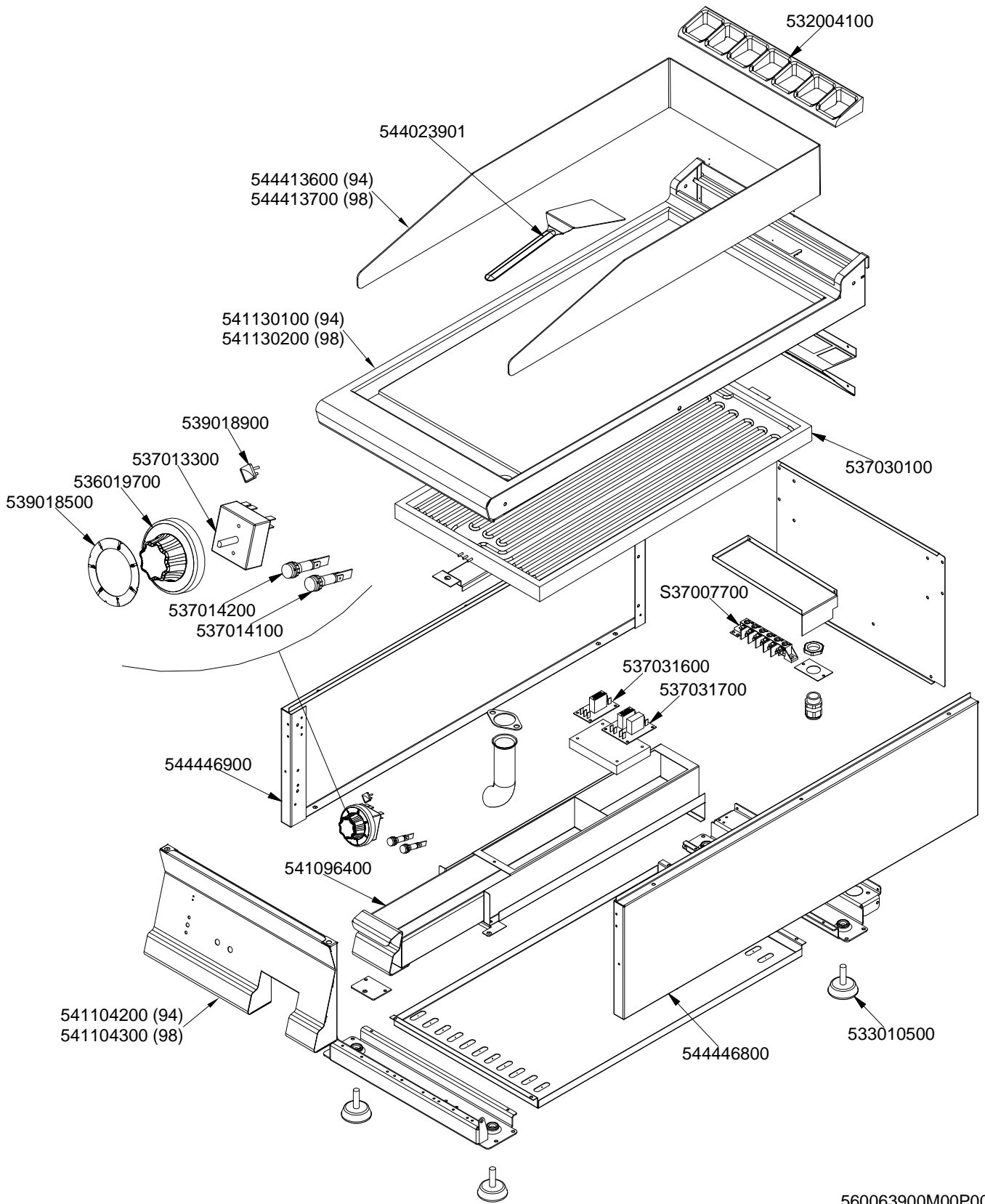

560063900M00P00.

Page	Pos	Code	Description
001		541104200	CONTROL PANEL FT-74E
001		544413600	SPLASH GUARD FT-94
001		541130100	UPPER PLATE FTC-94E WITH GLASS
001		544446800	
001		533010500	LEG M10*25 D.40
001		532004100	FLUE GRID L=370 70LINE (RAF)
001		544023901	SPATTLE FOR FRY-TOP
001		S37007700	
001		537030100	EL. CERAMIC PLATE 3500 FTC 90
001		544446900	
001		539018500	ADHESIVE GRADUATED DISC FOR KNOB
001		536019700	BLACK KNOB §70 PIN §6*5
001		537013300	CURRENT REGULATOR FOR ELEC. PLATE
001		539018900	INDEX FOR KNOB
001		537014200	GREEN WARNING LIGHT 250V
001		537014100	WHITE WARNING LIGHT 250V
001		537031700	ELECTRO BOARD 2 RELAI
001		537031600	ELECTRO BOARD 1 RELAI
001		541096400	DRIP TRAY FT S.70