

**Kühlung  
Schockfroster**

Artikel-Nr. 671004 (BF051DF)

---

**Explosionszeichnung / Ersatzteile**

---

Bitte bei Ersatzteilbestellung immer Seriennummer mit angeben!

**031 · 051 · 081 · 121 · 161**

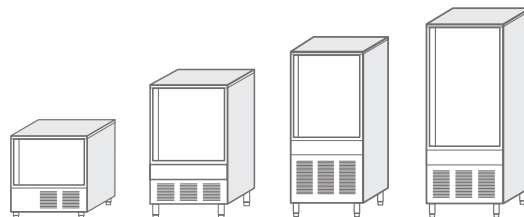

**IT**

**ABBATTITORI RAPIDI**  
per gastronomia, pasticceria, gelateria

**GB**

**BLAST CHILLER FREEZERS**  
for gastronomy, pastry, ice-cream

**DE**

**SCHNELLABKÜHLER SCHOCKFR.**  
für Gastronomy, Gebäck, Speiseeis

**FR**

**CELLULES REFROIDISSEMENT**  
pour gastronomie, pâtisserie, glacerie

**ES**

**ABATIDORES**  
para gastronomia, pasteleria, heladeria

**PT**

**EXPLUDA FREEZER**  
para o gastronomia, pastelaria, geleira

**GR**

**ΤΣΙΛΙ ΦΥΣΗΜΑΤΟΣ**  
για τη γαστρονομία, ζύμη, παγωτό

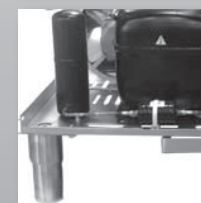
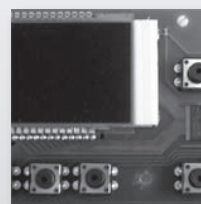

**ESC03071Z**

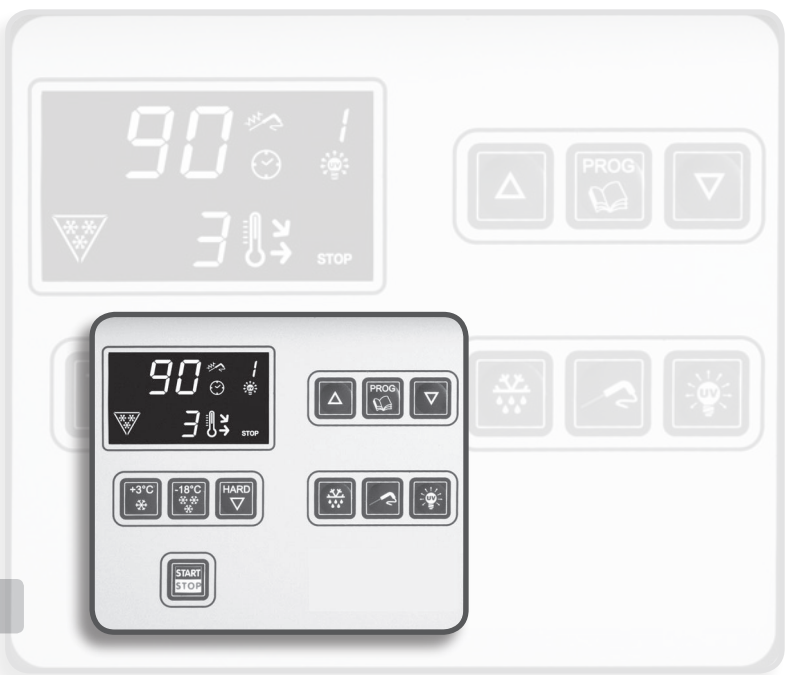
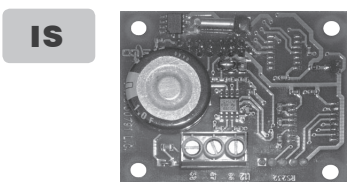
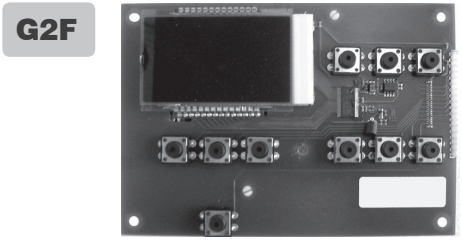

**MAS1**

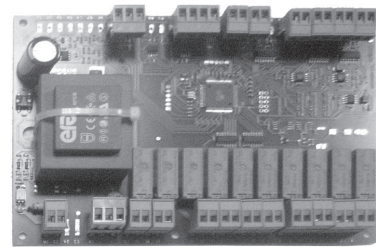

**G1P**

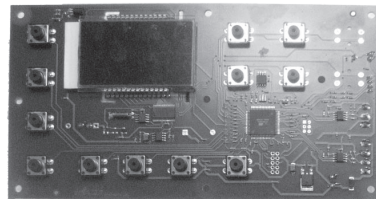

**G2P**



**G6P**



**CRS F/P+ST**

**CRS F/P**

**CRI**

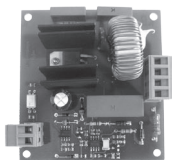

**G5**



**CK**

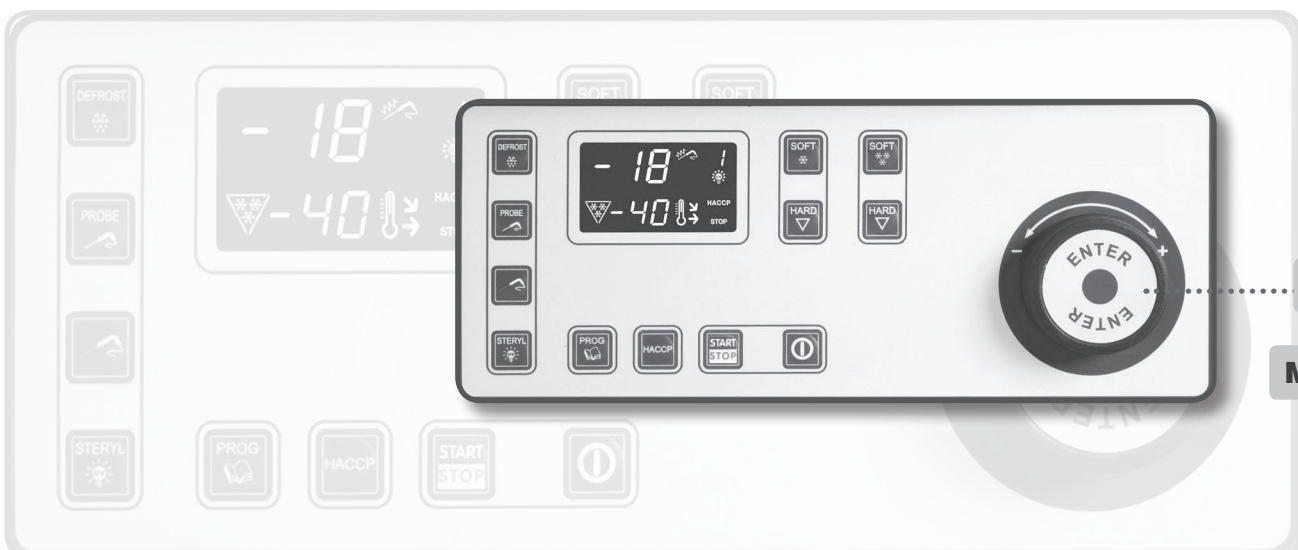

**ME**

**MAS2**

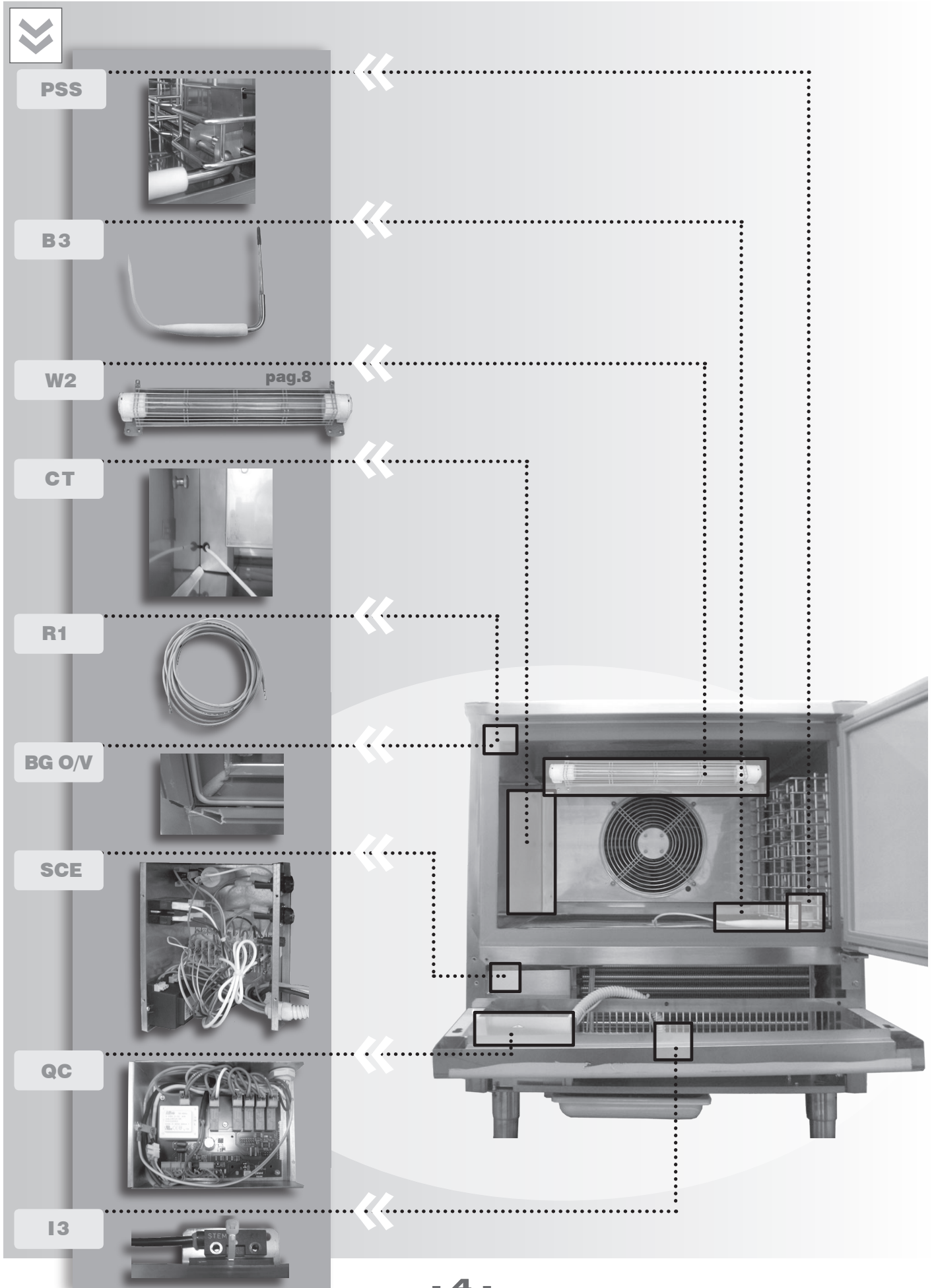



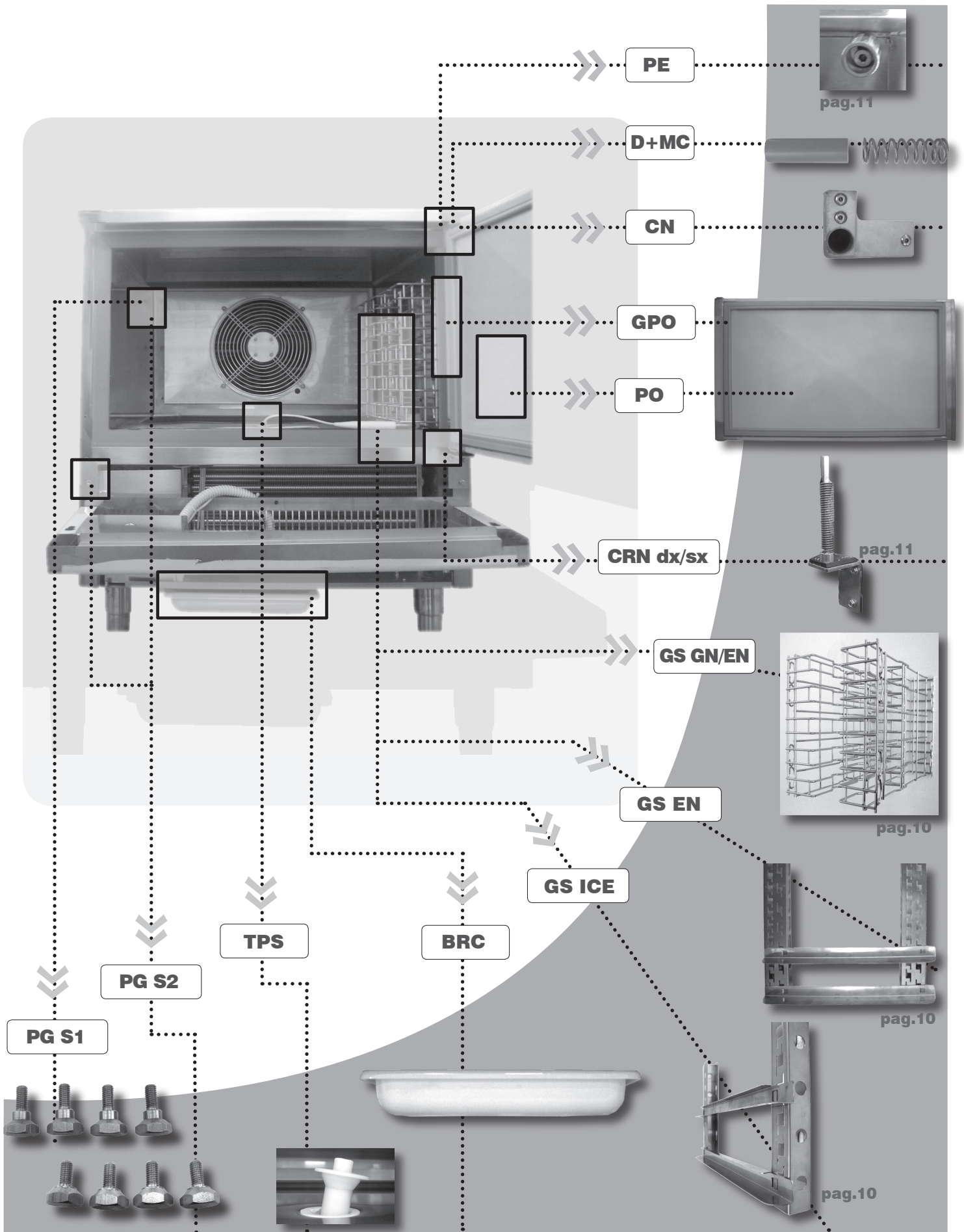

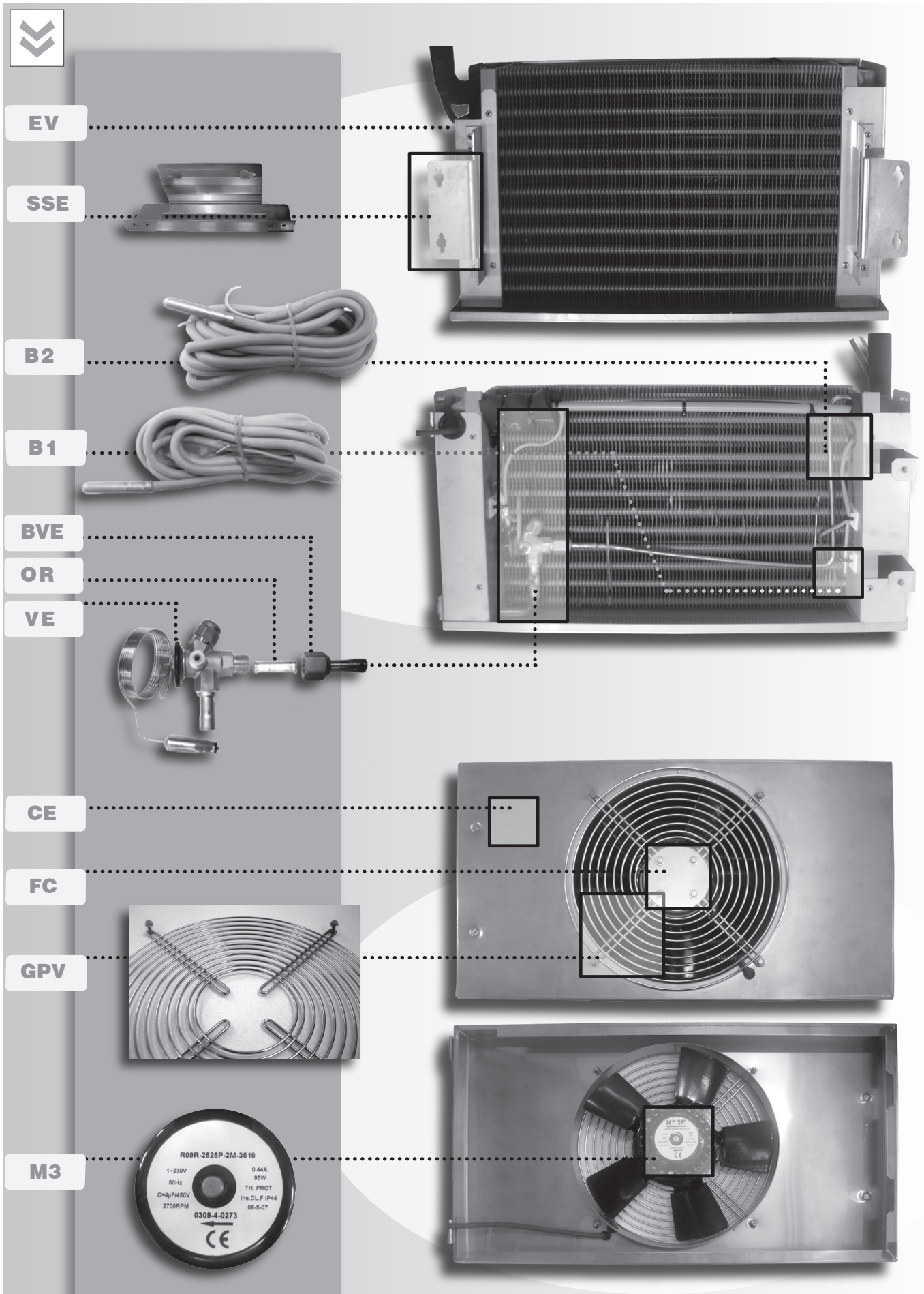

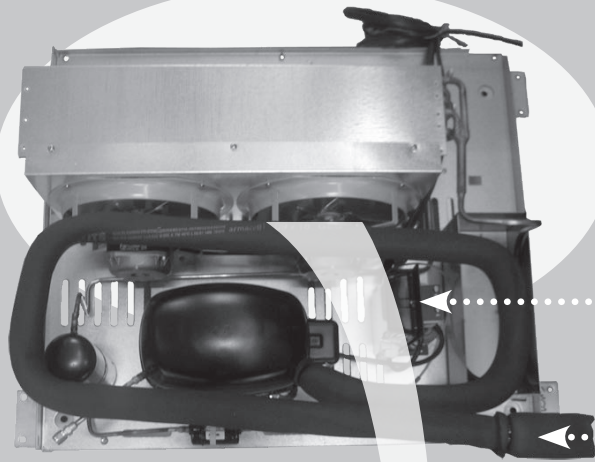

**BOX/m1**

**TS**

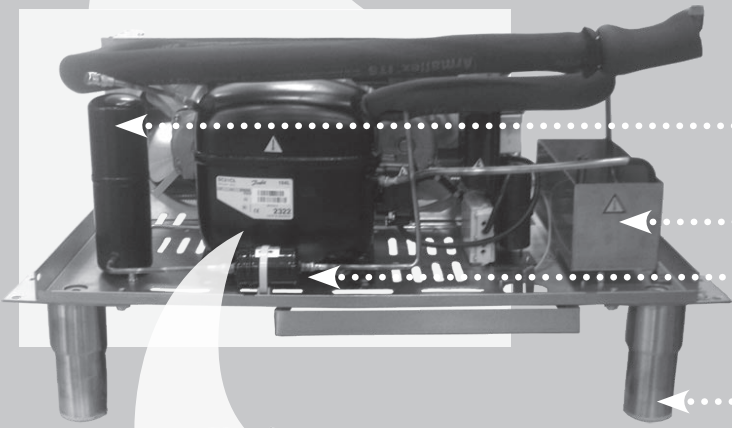

**RL**

**VC**

**F**

pag.10

**PI/PR**



**M1**



**M2**

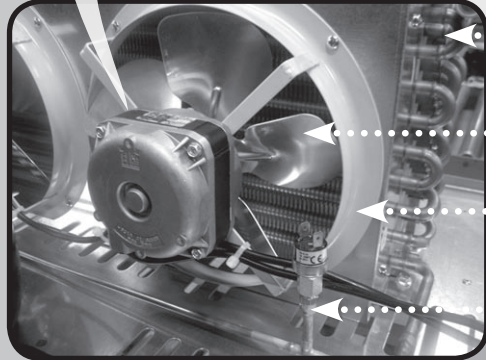

**CO**

**M2 V**

**AV**

**P**



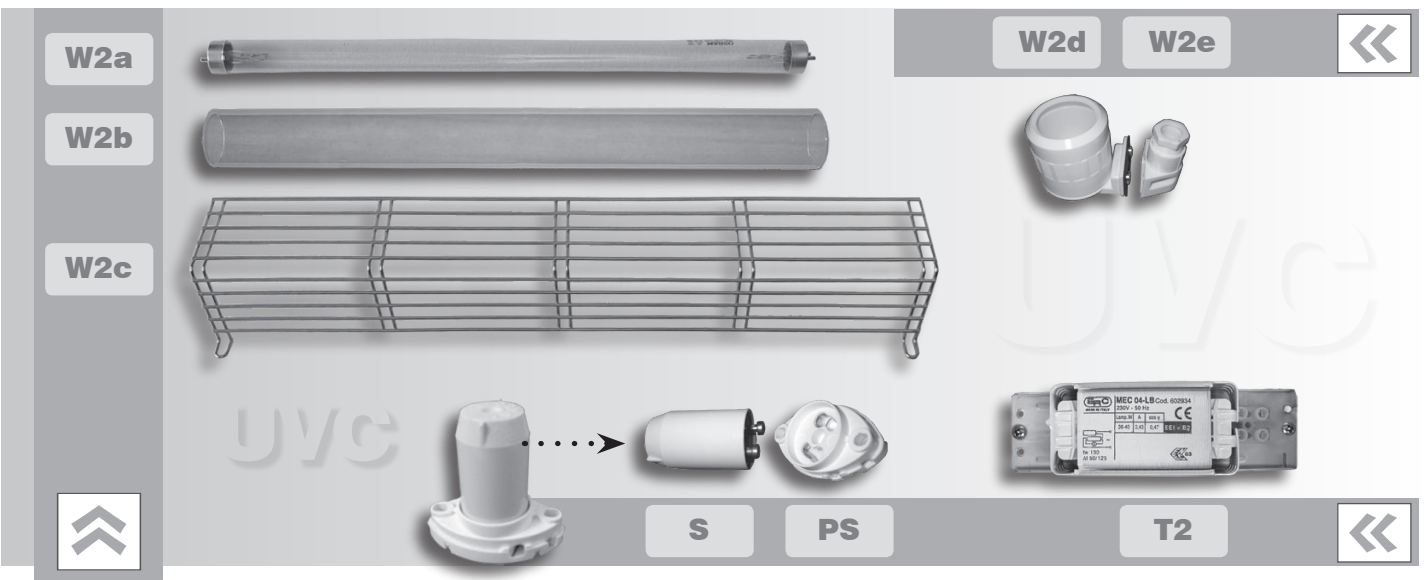
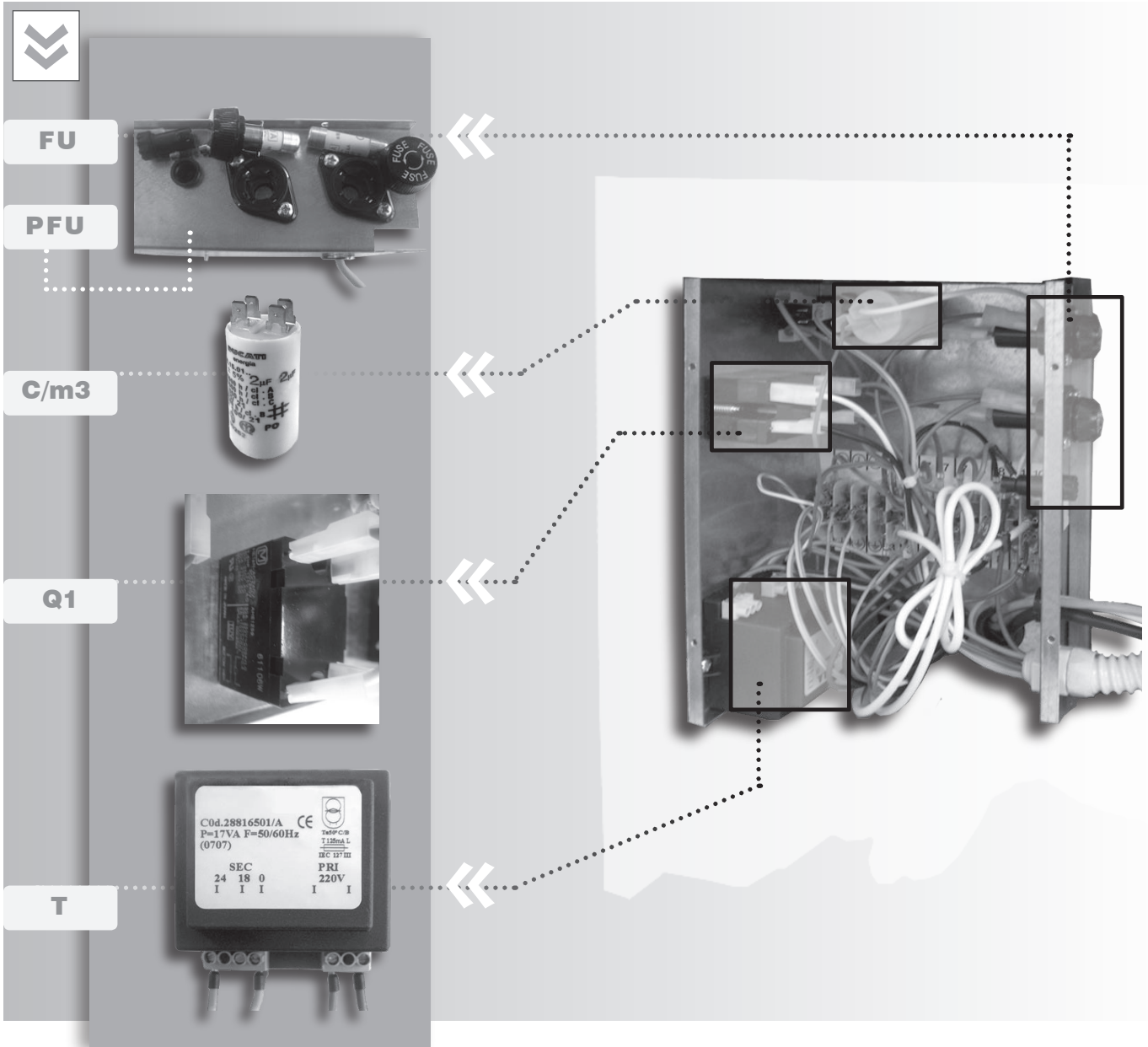

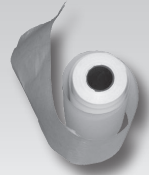
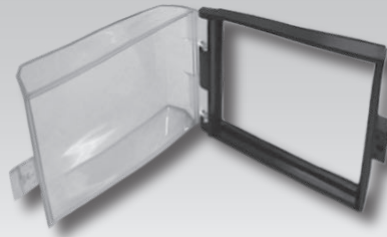

**ST**

**CST**

**SST**

**RC**

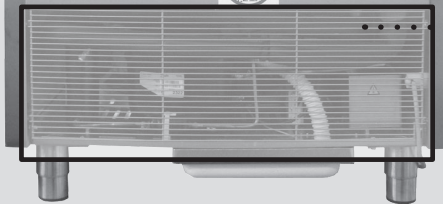

**GPP**



**TS1**

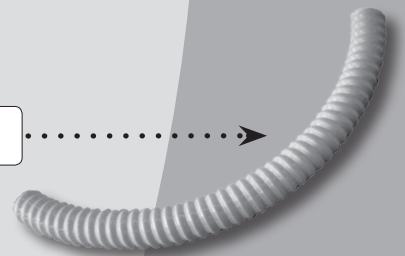

**FTO**

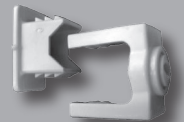

**TS2**



**SB1**

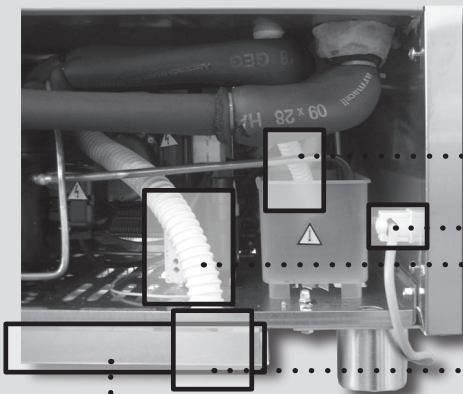

**SB**

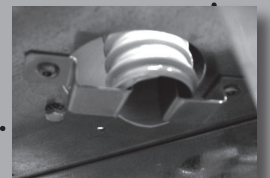
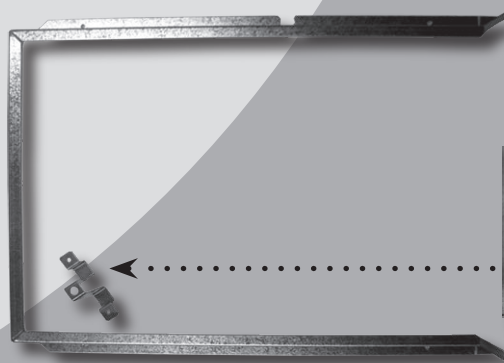



**GS GN/EN**

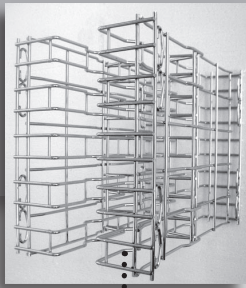

**GS 1/2/3/4**

**GS EN**

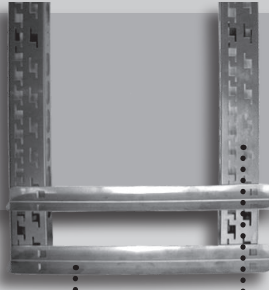

**GL P 1/2/3/4 dx/sx**

**GS ICE**

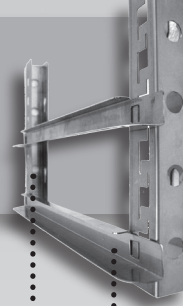

**GC I 1/2/3/4 dx/sx**

**GS PG 1/2/3/4/5/6/7/8 dx/sx**



**PI1**

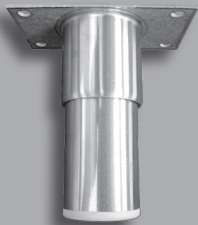

**PI2**



**PI3**



**PI4**



**PI5**



**PI6**



**PI7**



**PRS1**

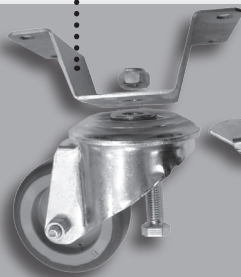

**PRS2**

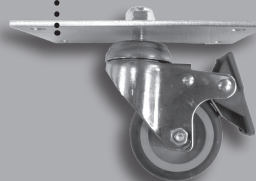

**PR1/2**

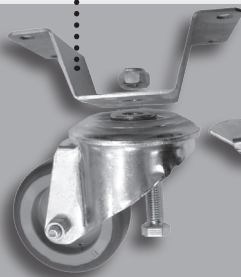

**PR3**

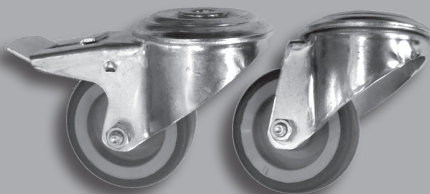

**PR4**



**PR5/6**

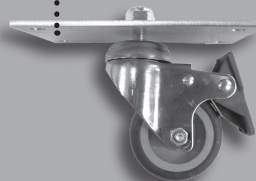

**PR7**



**PR8**





PE dx/sx



031



PE



CRN3 dx/sx

CRN2 dx/sx

CRN1 dx/sx

CRN dx/sx

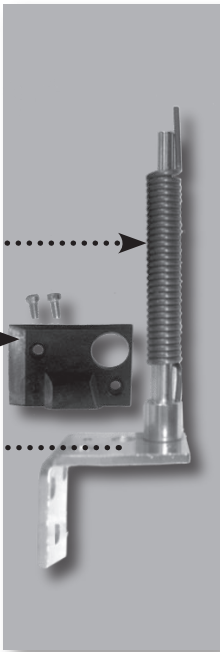

G1P

XA



x7

XB



x2

XC



x2

XD



x2



B08

B06

B04

B03

B02

B01



G2P

x9

x1



G2F

x9

x1



CRN



riferim. reference	codice code	descrizione description	modello model	da...a from...to	ricambi cons. rec. spare part
AC/M3	965438	COLLARE IN PLASTICA X CONV. D=250 PLASTIC RING FOR CONVEYOR D=250	051	__/__/__ 00/00/00	
AC/M3	965441	COLLARE IN PLASTICA X CONV. D=300 PLASTIC RING FOR CONVEYOR D=300	081 / 121 / 122	__/__/__ 00/00/00	
AV/M2	965324	ANELLO VENTILATORE ELC COND ABB ELECTRIC FAN RING ELCO COND. BLAST CHILLER	BF031A / BF051_ / B_081A / BF121D	03/03/07 00/00/00	
AV/M2	965346	ANELLO VENTIL ELC COND AB121 161 D=250 ELECTRIC FAN RING CON. BC121 161 D=250	121 / 161	__/__/__ 00/00/00	
B1	995562	SONDA PTC GRIGIA SILICONATA L=2500 CELLA PTC PROBE, GREY SILICONED L=2500 CABINET		01/01/95 00/00/00	<input type="checkbox"/>
B2	995500	SONDA PTC ROSSA SILICONATA L=2500 EVAPOR. PTC PROBE, RED SILICONED L=2500 EVAPORATOR		01/01/95 00/00/00	<input type="checkbox"/>
B3	965295	SONDA SPILL. PT1000 4 LIV 90° 5000 NON RISC. PIN PROBE PT1000 4 LIV 90° 5000 NO WARM	BC__P	22/02/07 00/00/00	<input type="checkbox"/>
B3	965296	SONDA SPILONE PT1000 4 LIV 90° 5000 RISC. PIN PROBE PT1000 4 LIV 90° 5000 WARM	BF__P	22/02/07 00/00/00	<input type="checkbox"/>
B3	996424	SONDA SPILL.PT1000 1 LIV.NO RIS 90°L=5 PIN PROBE PT1000 1 LIV. 90° 5000 NO WARM	BC__F	17/11/06 00/00/00	<input type="checkbox"/>
B3	996452	SONDA SPILONE PT1000 1 LIV 90° 5000 RISC. PIN PROBE PT1000 1 LIV 90° 5000 WARM	BF__F	16/01/07 00/00/00	<input type="checkbox"/>
BG O	965550	BATTUTA GUARNIZIONE AB L=737 ORIZZONTA HORIZONTAL PROF. FOR DOOR RABBET BC L=737		__/__/__ 00/00/00	
BG V	965551	BATTUTA GUARNIZIONE AB051 VERTICALE VERTICAL PROFILE FOR DOOR RABBET BC 051	051	__/__/__ 00/00/00	
BG V	965552	BATTUTA GUARNIZIONE AB081 VERTICALE VERTICAL PROFILE FOR DOOR RABBET BC 081	081	__/__/__ 00/00/00	
BG V	965553	BATTUTA GUARNIZIONE AB121 VERTICALE VERTICAL PROFILE FOR DOOR RABBET BC 121	121	__/__/__ 00/00/00	
BG V	965554	BATTUTA GUARNIZIONE AB161 VERTICALE VERTICAL PROFILE FOR DOOR RABBET BC 161	161	__/__/__ 00/00/00	
BG V	965558	BATTUTA GUARNIZIONE AB031 VERTICALE VERTICAL PROFILE FOR DOOR RABBET BC 031	031	__/__/__ 00/00/00	
BO1	996533	BOCCOLA PASSACAVO D=08 BUSH D=08		__/__/__ 00/00/00	
BO2	996534	BOCCOLA PASSACAVO D=12 BUSH D=12		__/__/__ 00/00/00	
BO3	996535	BOCCOLA PASSACAVO D=14 BUSH D=14		__/__/__ 00/00/00	
BO4	996536	BOCCOLA PASSACAVO D=19 BUSH D=19		__/__/__ 00/00/00	

riferim. reference	codice code	descrizione description	modello model	da...a from...to	ricambi cons. rec. spare part
BO6	996537	BOCCOLA PASSACAPO D=24 BUSH D=24		_/_/_ 00/00/00	
BO8	996538	BOCCOLA PASSACAPO D=42 BUSH D=42		_/_/_ 00/00/00	
BOX/M1	995978	BOX ELETTRICO ASPERA 'J9226GK' COMPRESSOR BOX ASPERA 'J9226GK'	BC081A	04/03/02 00/00/00	
BOX/M1	995979	BOX ELETTRICO ASPERA 'J2212GK' COMPRESSOR BOX ASPERA 'J2212GK'	BF081A / BF121D	04/03/02 00/00/00	
BOX/M1	996025	BOX ELETTRICO DANFOSS '117-7012' COMPRESSOR BOX DANFOSS '117-7012'	BF051_	22/05/00 00/00/00	
BRC	965283	BACINELLA RACC. CONENSA GN1/1 H50 PST NE BLACK BASIN GATHER CONDENS. GN1/1 H50 PST		22/02/07 00/00/00	
BV	996182	BOBINA HM2 230V 50/60HZ X VALV. SOLENOIDE COIL HM2 230V 50/60HZ FOR SOLENOID VALVE	051 / 081 / 121 / 161	09/01/03 00/00/00	□
BVE	965348	ADATTATORE VALV.ODF 10MM VALVE ADAPTER ODF 10MM		_/_/_ 00/00/00	
BVE	996539	ADATTATORE VALV.ODF 6MM VALVE ADAPTER ODF 6MM		_/_/_ 00/00/00	
C/M3	965315	CONDENSATORE ELETTR. 2,5MF 400V ELECTRIC CONDENSER 2,5MF 400V	081 / 121 / 161	26/02/07 00/00/00	
C/M3	996154	CONDENSATORE ELETTRICO MFP 2MF 400V ELECTRIC CONDENSER MFP 2MF 400V	031 / 051	28/08/02 00/00/00	
CE/M3	965349	CONVOGLIATORE BF031 EVAPORATOR COVERING BF031	031	_/_/_ 00/00/00	
CE/M3	965350	CONVOGLIATORE BF051 BF051 CONVEYOR	051	_/_/_ 00/00/00	
CE/M3	965351	CONVOGLIATORE BF081 BF081 CONVEYOR	081	_/_/_ 00/00/00	
CE/M3	965352	CONVOGLIATORE BF121 BF121 CONVEYOR	121	_/_/_ 00/00/00	
CE/M3	965353	CONVOGLIATORE BF161 BF161 CONVEYOR	161	_/_/_ 00/00/00	
CE/M3	965436	CONVOGLIATORE BF051 SENZA COLLARE EVAPORATORCONVEYOR BF051 WITHOUT RING	051	_/_/_ 00/00/00	
CE/M3	965439	CONVOGLIATORE BF121 SENZA COLLARI EVAPORATOR CONVEYOR BF121 WITHOUT RINGS	121	_/_/_ 00/00/00	
CE/M3	965442	CONVOGLIATORE BF161 SENZA COLLARI EVAPORATOR COVERING BF161 WITHOUT RINGS	161	_/_/_ 00/00/00	
CE/M3	965444	CONVOGLIATORE BF081 SENZA COLLARE EVAPORATOR CONVEYOR BF081 WITHOUT RING	081	_/_/_ 00/00/00	
CK	996496	BUZZER X SCHEDA EVCO EVCO CARD BUZZER		09/03/07 00/00/00	
CN	935723	CANNOTTO IN PLASTICA SUP. DX RIGHT UPPER PLASTIC TUBE		10/02/04 00/00/00	
CN	935724	CANNOTTO IN PLASTICA INF. DX RIGHT LOWER PLASTIC TUBE		10/02/04 00/00/00	
CO	965354	CONDENSATORE AB BC/BF081+ BC/BF121- BC BC/BF081+ BC/BF121 CONDENSER	B_081A / B_121D	_/_/_ 00/00/00	
CO	965355	CONDENSATORE BC161-2/3R BF161-2R BC/F1 BC161-2/3R BF161-2R BC/F1 CONDENSER	B_121A / BF161D / BC161A	_/_/_ 00/00/00	
CO	965356	CONDENSATORE BF161- BF122 BF161- BF122 CONDENSER	BF161A	_/_/_ 00/00/00	
CO	995117	CONDENSATORE 48 X 500 CONDENSER 48X500	BF031A / B_051_	01/01/95 00/00/00	

riferim. reference	codice code	descrizione description	modello model	da...a from...to	ricambi cons. rec. spare part
CR F	965722	ASS.CRUSC. ABB. 051 OLS PLRS BLAST CHILLER 051 FRONT PANEL OLS PLRS	031 / 051	26/11/07 00/00/00	
CRI	965460	PARTE INFERIORE ABB 121 OLIS POLARIS LOWER FRONTAL PANEL B.CHILLER OLIS POLARIS	121	13/07/07 00/00/00	
CRI	965501	PARTE INFERIORE ABB 161 POLARIS LOWER PANEL BLAST CHILLER 161 POLARIS	161	14/02/07 00/00/00	
CRI	965723	PARTE INF. CRUSCOTTO ABB. 081 PLRS LOWER FRONTAL PANEL B. CHILLER 081 PLRS	081	26/11/07 00/00/00	
CRN DX	965548	KIT CERNIERA INF.DX AB031-051-081-121-161 RIGHT LOWER HINGE KIT BC 031-051-081-121- 161		_/_/_- 00/00/00	
CRN SX	965549	KIT CERNIERA INF.SX AB031-051-081-121-161 LEFT LOWER HINGE KIT BC 031-051-081-121- 161		_/_/_- 00/00/00	
CRN1 DX	965240	ASS.CERNIERA INF. DX ABB. NEW LOWER RIGHT HINGE KIT BLAST CHILLER NEW		16/01/07 00/00/00	
CRN1 SX	996433	ASS.CERNIERA INF.SX ABB 051 LOWER LEFT HINGE KIT 051 BC		16/01/07 00/00/00	
CRN2 DX	935715	PIASTRA FERMO PORTA 'DX' 'PV' AR MNSC RIGHT DOOR STOP PLATE 'PV' MNSC CABINET		19/09/03 00/00/00	
CRN2 SX	935714	PIASTRA FERMO PORTA 'SX' 'PV' AR MNSC LEFT DOOR STOP PLATE 'PV' MNSC CABINET		19/09/03 00/00/00	
CRN3 DX	935697	MOLLA PORTA SX ARMADI CANOTTO IN ABS LEFT DOOR SPRING FOR ABS PLASTIC TUBE		15/04/03 00/00/00	
CRN3 SX	935696	MOLLA PORTA DX ARMADI CANOTTO IN ABS RIGHT DOOR SPRING FOR ABS PLASTIC TUBE		15/04/03 00/00/00	
CRS F	965359	CRUSCOTTO ABB FAST FRX CON SCATOLA COM BLAST CHILLER FRONTAL PANEL FAST WITH BOX	081 / 121 / 161 F	01/01/95 00/00/00	
CRS F - ST	965570	ASS.CRUSCOTTO 081->161 STD FRX C/FO ST FRONTAL PANEL FAST STD FRX WITH PRINT.HOLE	081 / 121 / 161 F	_/_/_- 00/00/00	
CRS P	965358	CRUSCOTTO ABB PLUS FRX CON SCATOLA COM 081-121-161 B.C. FRONTAL PANEL PLUS FRX	081 / 121 / 161 P	_/_/_- 00/00/00	
CRS P - ST	965569	ASS.CRUSCOTTO 081->161 TOP FRX C/FO ST FR.PANEL F B081->161 TOP FRX WITH PRIN.HOLE	081 / 121 / 161 P	_/_/_- 00/00/00	
CST	996492	COPERCHIO PLEX.PROTEZ.STP EVCO PLEXIGLASS COVER FOR EVCO PRINTER		02/03/07 00/00/00	
CT	965284	COPERTURA INOX TUBI EVAP. ABB. INOX COVERING TUBES EVAPORATOR B.CHILLER		22/02/07 00/00/00	

referim. reference	codice code	descrizione description	modello model	da...a from...to	ricambi cons. rec. spare part
DI	996572	DISTANZ.D=15 L=50 PVC PER CERN.SUP.ABB PVC SPACER D=15 L=50 FOR UPPER HINGE B.C.		__/__/__ 00/00/00	
DIS	925500	DISTANZIALE SCHIENALE TRS MC DONALD'S BACK SPACER TRS MC DONALD'S		__/__/__ 00/00/00	
EV	965289	BATTERIA EVAPORANTE ABB.051-7 3RANGHI EVAPORATOR BATTERY B.CHILLER 051-7 3 ROWS	051A	22/02/07 00/00/00	
EV	965290	BATTERIA EVAPORANTE ABB.051-7 2RANGHI EVAPORATOR BATTERY B.CHILLER 051-7 2 ROWS	051D	22/02/07 00/00/00	
EV	965360	BATTERIA EVAPORANTE ABB081 3R EVAPORATOR BATTERY B.CHILLER 081 3 ROWS	081A	__/__/__ 00/00/00	
EV	965361	BATTERIA EVAPORANTE ABB121 3R EVAPORATOR BATTERY B.CHILLER 121 3 ROWS	121A	__/__/__ 00/00/00	
EV	965375	BATTERIA EVAPORANTE ABB161 2R EVAPORATOR BATTERY B.CHILLER 161 2 ROWS	161D	__/__/__ 00/00/00	
EV	965376	BATTERIA EVAPORANTE ABB041 3R EVAPORATOR BATTERY B.CHILLER 041 3 ROWS	031A	__/__/__ 00/00/00	
EV	965650	BATTERIA EVAPORANTE ABB161 3RANGHI EVAPORATOR BATTERY BC161 THREE ROWS	161A	__/__/__ 00/00/00	
F	995690	FILTRO DISIDRATATORE ODF DML032S 023Z455 DEHYDRATOR FILTER ODF DML032S 023Z455	031 / 051 / 081	02/05/04 00/00/00	
F	996269	FILTRO DISIDRATATORE ODF DML033S 023Z455 DEHYDRATOR FILTER ODF DML033S 023Z455	121 / 161	07/09/04 00/00/00	
FC	996364	FONDELLO COPERTURA ROTORE VENT. D=300 BOTTOM COVERING ROTOR FAN D=300		27/03/06 00/00/00	
FTO	965308	FISSATUBO OBO 3040 LGK D=6-16 MM OBO CLIP 3040 LGK D=6-16 MM		23/02/07 00/00/00	
FU	995919	FUSIBILE 10A AM 10X38 ABB.1F FUSE 10A AM 10X38 BC 1F		02/08/06 00/00/00	<input type="checkbox"/>
G1/G2/G6P	996383	ASSIEME SCHEDA ELETTR. TOP FRX ABB/CONG. ELECTRIC CARD ASSEMBLY TOP FRX BC/BF	PLUS	26/05/06 12/09/07	<input type="checkbox"/>
	996594	ASSIEME SCHEDA EVCO AB PLUS-FRX 128K ELECTRIC CARD ASS. EVCO BC PLUS FRX 128K	PLUS	13/09/07 00/00/00	<input type="checkbox"/>
G1F	996384	ASSIEME SCHEDA ELETTR. STD FRX ABB/CONG. ELECTRIC CARD ASSEMBLY STD FRX BC/BF	FAST	26/05/06 00/00/00	<input type="checkbox"/>
G1P	996380	SCHEDA POTENZA TOP ABB/CONG. POWER CARD TOP BC/BC	PLUS	26/05/06 12/09/07	<input type="checkbox"/>
	996595	SCHEDA POTENZA EVCO AB FRX-HIB C/PWM POWER CARD EVCO BC FRX-HIB C/PWM	PLUS	13/09/07 00/00/00	<input type="checkbox"/>



referim. reference	codice code	descrizione description	modello model	da...a from...to	ricambi cons. rec. spare part
G2P	996381	SCHEDA TASTIERA TOP FRX ABB/CONG. KEYBOARD CARD TOP FRX BC/BF	PLUS	26/05/06 12/09/07	<input type="checkbox"/>
	996593	SCHEDA TASTIERA EVCO TOP FRX 128K KEYBOARD CARD EVCO TOP FRX 128K	PLUS	10/03/08 00/00/00	<input type="checkbox"/>
G4	990584	KIT STAMPANTE ABB 051 PRINTER KIT BC 051		_/_/_ 00/00/00	
G5	996606	SCHEDA ESPANSIONE TAGLIO FASE 600W 50H EXPANSION ENCODER CUTTING PHASE 600W 50H	PLUS	_/_/_ 00/00/00	<input type="checkbox"/>
G6P	996382	SCHEDA ENCODER TOP FRX ABB/CONG. ENCODER CARD TOP FRX BC/BF	PLUS	26/05/06 00/00/00	<input type="checkbox"/>
GC I	935966	COPPIA GUIDE A "C"25X40X360.5 GELATO PAIR OF TELESC. GUIDES "C" 25X40X360.5 ICE	031 / 051	_/_/_ 00/00/00	
GC I	935967	COPPIA GUIDE A "C"25X25X390 GELATO PAIR OF TELESCOPIC GUIDES "C" 25X25X390 ICE	081 / 121 / 161	_/_/_ 00/00/00	
GC I1	965377	GUIDA A "C" AB L360 DX GELATERIA RIGHT "C" SLIDE AB L360 ICE-CREAM	031 / 051	_/_/_ 00/00/00	
GC I1	965378	GUIDA A "C" AB L360 SX GELATERIA LEFT "C" SLIDE AB L360 ICE-CREAM	031 / 051	_/_/_ 00/00/00	
GC I2	965379	GUIDA A "C" AB L390 DX GELATERIA RIGHT "C" SLIDE AB L390ICE-CREAM	081 / 121 / 161	_/_/_ 00/00/00	
GC I2	965380	GUIDA A "C" AB L390 SX GELATERIA LEFT "C" SLIDE AB L390 ICE-CREAM	081 / 121 / 161	_/_/_ 00/00/00	
GL P	935957	COPPIA GUIDE A "L"40X25X390 ABB081-161 PAIR OF GUIDES "L" 40X25X390 BC 081-161	081 / 121 / 161	15/09/06 00/00/00	
GL P	996447	COPPIA GUIDE "L" ABB.051 DX+SX PASTICC PAIR OF GUIDES "L" BC051 RIGHT&LEFT PASTRY	031 / 051	09/01/07 00/00/00	
GL P1	965383	GUIDA A "L" AB L360 DX ABB RUGHT "L" SLIDE L360 BLAST CHILLER	031 / 051	_/_/_ 00/00/00	
GL P1	965384	GUIDA A "L" AB L360 SX ABB LEFT "L" SLIDE L360 BLAST CHILLER	031 / 051	_/_/_ 00/00/00	
GL P2	965381	GUIDA A "L" AB L390 DX ABB RIGHT "L" SLIDE L390 BLAST CHILLER	081 / 121 / 161	_/_/_ 00/00/00	
GL P2	965382	GUIDA A "L" AB L390 SX ABB LEFT "L" SLIDE AB L390 BLAST CHILLER	081 / 121 / 161	_/_/_ 00/00/00	
GPO	965298	GUARN.PORTA BF081 650X690 DOOR GASKET BF081 650X690	081	_/_/_ 00/00/00	<input type="checkbox"/>
GPO	965299	GUARNIZIONE PORTA BF161 1130X690 DOOR GASKET BF161 1130X690	161	_/_/_ 00/00/00	<input type="checkbox"/>
GPO	965385	GUARN.PORTA BF031 DOOR GASKET BF031	031	_/_/_ 00/00/00	<input type="checkbox"/>
GPO	996453	NN01 GUARNIZIONE PORTA BF051 400X690 NN01 DOOR GASKET BF051 400X690	051	_/_/_ 00/00/00	<input type="checkbox"/>
GPO	996457	NN01 GUARN.PORTA BF121 850X690 NN01 DOOR GASKET BF121 850X690	121	_/_/_ 00/00/00	<input type="checkbox"/>
GPP	965292	GRIGLIA DI PROTEZIONE POSTER. ABB.051 BACK GRID PROTECTION BLAST CHILLER 051	031 / 051	22/02/07 00/00/00	
GPP	965386	GRIGLIA DI PROTEZ.POSTER. ABB.081 BACK GRID PROTECTION BLAST CHILLER 081	081	_/_/_ 00/00/00	
GPP	965387	GRIGLIA DI PROTEZ.POSTER. ABB.121 BACK GRID PROTECTION BLAST CHILLER 121	121	_/_/_ 00/00/00	

referim. reference	codice code	descrizione description	modello model	da...a from...to	ricambi cons. rec. spare part
GPP	965388	GRIGLIA DI PROTEZ.POSTER. ABB.161 BACK GRID PROTECTION BLAST CHILLER 161	161	__/__/__ 00/00/00	
GPV	965309	GRIGLIA PROTEZIONE VENTOLA EVAP.051 D250 BLADE EVAPORATOR PROTECTION GRID 051 D250	051	26/02/07 00/00/00	
GPV	965310	GRIGLIA PROTEZ.VENT.EVAP.081 D300 BLADE EVAPORATOR GRID PROTECTION 081 D300	081	26/02/07 00/00/00	
GPV	995753	GRIGLIA METALLICA VENTILAT.'ECOFIT' METAL GRID 'ECOFIT' FAN	031	18/09/96 00/00/00	
GPV	995991	GRIGLIA PROT. VENTILATORE D=300 ABBATT FAN GRID PROTECTION D=300 BLAST CHILLER	081 / 121 / 161	21/02/05 00/00/00	
GPV	996601	GRIGLIA PROT.VENT.EBM D=300 AB FAN GRID PROTECTION EBM D=300 BL. CHILLER	081 / 121 / 161	__/__/__ 00/00/00	
GS PG0	965644	MONTANTE DX GN ABB 031 RIGHT UPRIGHT GN BLAST CHILLER 031	031 GN	__/__/__ 00/00/00	
GS PG0	965645	MONTANTE SX GN ABB 031 LEFT UPRIGHT GN BLAST CHILLER 031	031 GN	__/__/__ 00/00/00	
GS PG0	965655	MONTANTE DX 041 EN RIGHT UPRIGHT 041 EN	031 EN / ICE	__/__/__ 00/00/00	
GS PG0	965656	MONTANTE SX 041 EN LEFT UPRIGHT 041 EN	031 EN / ICE	__/__/__ 00/00/00	
GS PG1	935970	ASS.MONT.DX PORTASPILLONE AB051 EN RIGHT UPRIGHT PROBE-HOLDER B.C. 051 EN	051 EN	08/01/07 00/00/00	
GS PG1	996446	ASS.MONT.SX BF051 EN LEFT UPRIGHT BF051 EN	051 EN	09/01/07 00/00/00	
GS PG2	965392	MONTANTE DX BF081 EN RIGHT UPRIGHT BF081 EN	081 EN	__/__/__ 00/00/00	
GS PG2	965393	MONTANTE SX BF081 EN LEFT UPRIGHT BF081 EN	081 EN	__/__/__ 00/00/00	
GS PG3	965394	MONTANTE SX BF121 EN LEFT UPRIGHT BF121 EN	121 EN	__/__/__ 00/00/00	
GS PG3	965395	MONTANTE DX BF121 EN RIGHT UPRIGHT BF121 EN	121 EN	__/__/__ 00/00/00	
GS PG4	965396	MONTANTE DX BF161 EN RIGHT UPRIGHT BF161 EN	161 EN	__/__/__ 00/00/00	
GS PG4	965397	MONTANTE SX BF161 EN LEFT UPRIGHT BF161 EN	161 EN	__/__/__ 00/00/00	
GS1	965286	STRUTT.PORTAT.IN TOND.DX/SX ABB.051 RIGHT/LEFT ROD FRAME TRAY HOLDER B.C. 051	031 / 051	22/02/07 00/00/00	
GS2	965389	STRUTT.PORTAT.IN TOND.DX/SX ABB.081 RIGHT/LEFT ROD FRAME TRAY HOLDER B.C. 081	081	__/__/__ 00/00/00	
GS3	965390	STRUTT.PORTAT.IN TOND.DX/SX ABB.121 RIGHT/LEFT ROD FRAME TRAY HOLDER B.C. 121	121	__/__/__ 00/00/00	
GS4	965391	STRUTT.PORTAT.IN TOND.DX/SX ABB.161 RIGHT/LEFT ROD FRAME TRAY HOLDER B.C. 161	161	__/__/__ 00/00/00	
I3	995405	MICROPORTA MAGNETICO STEM E510 MAGNETIC MICRO-SWITCH STEM E510		01/01/95 00/00/00	<input type="checkbox"/>
IS	996441	SCHEDINA SERIALE X SIST.FAST AGGIUNTIVA PRINTER KIT FOR ADDICTIONAL FAST SISTEM	FAST	22/12/06 00/00/00	<input type="checkbox"/>

referim. reference	codice code	descrizione description	modello model	da...a from...to	ricambi cons. rec. spare part
K1	965694	CONTATTORE MOELLER DIL EM-10 BOB.230V CONTACTOR TELEMECAn. DIL EM-10 BOB.230V	121A / 161	__/__/00 00/00/00	<input type="checkbox"/>
KIT M2	965318	ASS. VENTIL. ELCO D=200-34°-VNT10-20+CON ELCO FAN D=200-34°-VNT10-20+CON	041 / 051 / 081	26/02/07 00/00/00	<input type="checkbox"/>
KIT M2	965319	ASS. VENTIL. ELCO D=254-34°-VNT35-45+CON ELCO FAN D=254-34°-VNT35-45+CON	121 / 161	26/02/07 00/00/00	<input type="checkbox"/>
M1	965326	COMPRESSORE ABB BF161+122-TEC TAG2516Z B.C. BF161+122-TEC TAG2516Z COMPRESSOR	BF161A	16/03/07 00/00/00	
M1	965362	COMPRESSORE U.H TFH4531Z R404A 400V U.H TFH4531Z R404A 400V COMPRESSOR	BC161A	__/__/00 00/00/00	
M1	965398	COMPRESSORE ASPERA T6217GK R404A T6217GK R404A ASPERA COMPRESSOR	BC051A	__/__/00 00/00/00	
M1	965399	COMPRESSORE TFH2511Z-K UL 208/3/60 TFH2511Z-K UL 208/3/60 COMPRESSOR	BF121A / BF161D	__/__/00 00/00/00	
M1	995711	COMPRESSORE 34,37CC J2212GK CSR R404A 34,37CC J2212GK CSR R404A COMPRESSOR	BF081A / BF121D	01/01/95 00/00/00	
M1	995745	COMPRESSORE 17,4 CC T2168GK/SC15CL R40 17,4 CC T2168GK/SC15CL R40 COMPRESSOR	031A	01/03/98 00/00/00	
M1	995746	COMPRESSORE 20,4 CC T2178GK/SC18CL R40 20,4 CC T2178GK/SC18CL R40 COMPRESSOR	BF051D	16/02/99 00/00/00	
M1	995770	COMPRESSORE 22,4 CC.T2180GK-SC21CL R40 22,4 CC.T2180GK-SC21CL R40 COMPRESSOR	BF051A	30/04/97 00/00/00	
M1	995925	COMPRESSORE 21,7 CC J9226GK CSR R404A 21,7 CC J9226GK CSR R404A COMPRESSOR	BC081A / BC121D	23/10/98 00/00/00	
M1	995926	COMPRESSORE J9238GS R404A J9238GS R404A COMPRESSOR	BC121A / BC161D	25/01/99 00/00/00	
M1	996391	COMPRESSORE ASPERA NE9213 GK R404A NE9213 GK R404A ASPERA COMPRESSOR	BC051D	03/07/06 00/00/00	
M2	965781	MOTORE CONDENSATORE ELC PER VENT D=254 CONDENSER FAN ELC D=254	121 / 161	__/__/00 00/00/00	<input type="checkbox"/>
M2	965782	MOTORE CONDENSATORE ELC PER VENT D=200 CONDENSER FAN ELC =200	041 / 051 / 081	__/__/00 00/00/00	<input type="checkbox"/>
M2 V	965325	VENTOLA VENTILATORE ELC COND. ABB.051 BLADE FAN ELC COND. BLAST CHILLER 501	031 / 051 / 081	03/03/07 00/00/00	<input type="checkbox"/>
M2 V	965780	VENTOLA CONDENSATORE ELC D=254 CONDENSER FAN ELC D=254	121 / 161	__/__/00 00/00/00	<input type="checkbox"/>
M3	965313	VENT. ROTOMATIKA D250 2P R09R-2525P-2M- 351 ROTOMATIKA FAN D250 2P R09R-2525P-2M- 351	051	26/02/07 00/00/00	<input type="checkbox"/>

riferim. reference	codice code	descrizione description	modello model	da...a from...to	ricambi cons. rec. spare part
M3	965314	VENT. ROTOMATIKA D300 4P R09R-3028P-4M-3508 ROTOMATIKA FAN D300 4P R09R-3028P-4M-3508	081 / 121 / 161	01/01/07 28/01/07	<input type="checkbox"/>
	995870	VENTILATORE EVAPORATORE D=300 MONOFASE EVAPORATOR FAN D=300 MONO-PHASIC		29/01/07 00/00/00	<input type="checkbox"/>
M3	995910	VENTILATORE ASSIALE 2VRE15 200A AXIAL FAN 2VRE15 200A	031	08/10/98 00/00/00	<input type="checkbox"/>
MAS1	965434	MASCHERINA COMANDI ABB. STD (PLS) CONTROL PANEL BLAST CHILLER STD (PLS)	FAST	14/06/07 00/00/00	
MAS2	965435	MASCHERINA COMANDI ABB. TOP (PLS) CONTROL PANEL BLAST CHILLER TOP (PLS)	PLUS	14/06/07 00/00/00	
MC	925598	MOLLA X CERNIERA AUTOC.CRUS.TR H=650 HINGE DOOR SPRING SELF-LOCK TR H=650		11/12/02 00/00/00	
ME	965171	MANOPOLA ENCODER SCHEDE ABBATTITORE ENCODER KNOB FOR BLAST CHILLER	PLUS	16/11/04 00/00/00	<input type="checkbox"/>
OR	996263	ORIFIZIO N°01 ODF DANFOSS N.01 ORIFICE ODF DANFOSS	BF031A / B_051_	07/09/04 00/00/00	
OR	996264	ORIFIZIO N°02 ODF DANFOSS N.02 ORIFICE ODF DANFOSS	B_081A / BF121D / BC121A	07/09/04 00/00/00	
OR	996265	ORIFIZIO N°03 ODF DANFOSS N.03 ORIFICE ODF DANFOSS	BF121A / BC161A / BF161_	07/09/04 00/00/00	
P	996449	PRESSOSTATO DANFOSS CB 061F8486 ACB2UB136 DANF. PRESS, SWITCH CB 061F8486 ACB2UB136		16/01/07 00/00/00	<input type="checkbox"/>
PE	965282	PERNO CON ASOLA CERNIERA SUP ABB. UPPER SLOT PIN HINGE BLAST CHILLER	051 / 081 / 121 / 161	22/02/07 00/00/00	
PE dx	965524	ASS.CERNIERA SUP.DX ABB. BF 031/41 UPPER RIGHT HINGE BLAST CHILLER BF 031	031	_/_/_ 00/00/00	
PE sx	965523	ASS.CERNIERA SUP.SX ABB. BF 031/41 UPPER LEFT HINGE BLAST CHILLER BF 031	031	_/_/_ 00/00/00	
PFU	996088	PORTAFUS HK10380 X FU10X38 WEBER 1POLO FUSE-CARRIER 10X38 FOR FU10X38 WEBER 1 POLE		25/09/01 00/00/00	
PG S1	965307	PERNO FILETTATO AGG. MONTANTI ABB. NEW THREADED PIN FOR COUPLER UPRIGHTS B.C. NEW	GN	23/02/07 00/00/00	
PG S2	995493	PERNO FILETTATO X MONTANTI ABB. THREADED PIN FOR UPRIGHTS BLAST CHILLER	EN	01/01/95 00/00/00	
PI1	990581	ASS.PIEDINO 2' FOOT ASSEMBLY 2'	081 / 121 / 161	_/_/_ 00/00/00	
PI2	995012	PIEDE INOX LISCIO DA 2"G AR MNSC SMOOTH FOOT INOX 2"G MNSC CABINET	081 / 121 / 161	01/01/95 00/00/00	
PI3	990582	TAPPO X PIEDE 2' PVC GRIGIO GREY FOOT PLUG 2' PVC	081 / 121 / 161	_/_/_ 00/00/00	
PI4	995011	SUPPORTO PIEDE INOX AR MNSC FOOT SUPPORT INOX MNSC CABINET		01/01/95 00/00/00	
PI5	965347	TAPPO X PIEDE 2' PVC NERO BLACK FOOT 2' PLUG	031 / 051	_/_/_ 00/00/00	
PI6	965365	PIEDE INOX 2' GAS L=75 ABB 051 NOX FOOT 2' GAS L=75 ABB 051	031 / 051	_/_/_ 00/00/00	



riferim. reference	codice code	descrizione description	modello model	da...a from...to	ricambi cons. rec. spare part
PI7	965237	ASS.PIED. INOX 2'REG 78/110 AA69ECNR8CAN INOX FOOT ASS. 2'REG 78/110 AA69ECNR8CAN	031 / 051	11/12/06 00/00/00	
PO	965246	ASS.PORTA SCHIUMATA BF051 2007 DOOR FOR BF051 BLAST CHILLER 2007	051	23/01/07 00/00/00	
PO	965366	PORTA SCHIUMATA ABB 041 DOOR FOR 041 BLAST CHILLER	031	_/_/_ 00/00/00	
PO	965367	PORTA SCHIUMATA ABB 081 DOOR FOR 081 BLAST CHILLER	081	_/_/_ 00/00/00	
PO	965369	PORTA SCHIUMATA ABB 121 DOOR FOR 121 BLAST CHILLER	121	_/_/_ 00/00/00	
PO	965371	PORTA SCHIUMATA ABB 161 DOOR FOR 161 BLAST CHILLER	161	_/_/_ 00/00/00	
PR1	996545	ASS. RUOTA ANTERIORE C/FRENO D=80 FRONT CASTOR WITH BRAKE D=80	081 / 121 / 161	_/_/_ 00/00/00	
PR2	996546	ASS. RUOTA ANTERIORE S/FRENO D=80 FRONT CASTOR WITHOUT BRAKE D=80	081 / 121 / 161	_/_/_ 00/00/00	
PR3	996015	RUOTA GIREVOLE D=80 CON FRENO REVOLVING CASTOR D=80 WITH BRAKE	081 / 121 / 161	20/03/00 00/00/00	
PR4	996014	RUOTA GIREVOLE D=80 SENZA FRENO REV. CASTOR D= 80 WITHOUT BRAKE	081 / 121 / 161	20/03/00 00/00/00	
PR5	996551	ASS.RUOTA ANTERIORE C/FRENO D=60 REVOLVING CASTOR ASS. D=60 WITH BRAKE	031 / 051	_/_/_ 00/00/00	
PR6	996552	ASS.RUOTA ANTERIORE S/FRENO D=60 REVOLVING CASTOR ASS, D=60 WITHOUT BRAKE	031 / 051	_/_/_ 00/00/00	
PR7	996540	RUOTA GIR D= 60 CROMATA CON FRENO REVOLVING CASTOR D= 60 CROMATE WITH BRAKE	031 / 051	_/_/_ 00/00/00	
PR8	996541	RUOTA GIR D= 60 CROMATA S/FRENO REV. CASTOR D=60 CROMATE WITHOUT BRAKE	031 / 051	_/_/_ 00/00/00	
PRS1	925557	SUPPORTO RUOTA D=80 TR H=150 CASTOR BEARING D=80 TR H=150	081 / 121 / 161	20/03/00 00/00/00	
PRS2	965373	PIASTRA SUPP.RUOTA ABB051 BEARING CASTOR PLATE B. CHILLER 051	031 / 051	_/_/_ 00/00/00	
PS	996583	PORTASTARTER PER LAMPADE FL HOLDER-STARTER DEVICE FOR TUBULAR LAMP	081 / 121 / 161	_/_/_ 00/00/00	
PSS	965285	PIASTRINA SUPPORTO SONDA SPILLONE BEARING HEARTH PROBE PLATE	GN	22/02/07 01/11/07	
Q1	995345	RELE' DI POTENZA 30A 250V POWER RELAY 30A 250V	031 / 051 / 081 / 121D	01/01/95 00/00/00	<input type="checkbox"/>
R1	965301	RESIS.CORNICE PO.ABB081 10W/M FRAME HEATER DOOR B.C. 081 10W/M	081	23/02/07 00/00/00	<input type="checkbox"/>
R1	965302	RESIS.CORNICE PO.ABB051 10W/M FRAME HEATER DOOR B.C. 051 10W/M	031 / 051	23/02/07 00/00/00	<input type="checkbox"/>
R1	965303	RESIS.CORNICE PO.ABB161 10W/M FRAME HEATER DOOR B.C. 161 10W/M	161	23/02/07 00/00/00	<input type="checkbox"/>
R1	996456	RESIS.CORNICE PO.ABB121 10W/M FRAME HEATER DOOR B.C. 121 10W/M	121	16/01/07 00/00/00	<input type="checkbox"/>
RC	996493	ROTOLO CARTA X STAMPANTE EVCO PM100AX9 ROLL OF PRINTER PAPER EVCO PM100AX9		02/03/07 00/00/00	
RL	965374	RICEVITORE LIQUIDO V=1,5 LIQUID RECEIVER V=1,5	161	_/_/_ 00/00/00	
RL	995161	RICEVITORE DI LIQUIDO 0,85 LITRI LIQUID RECEIVER 0,85 LITERS	121	01/01/95 00/00/00	
RL	995906	RICEVITORE DI LIQUIDO 0,58 LITRI LIQUID RECEIVER 0,58 LITERS	031 / 051 / 081	08/10/98 00/00/00	

referim. reference	codice code	descrizione description	modello model	da...a from...to	ricambi cons. rec. spare part
S	995851	STARTER PER TUBI AL NEON STARTER DEVICE FOR TUBULAR LAMP	081 / 121 / 161	14/09/98 00/00/00	
SB	965293	SUPPORTO BACINELLA RACC.CONDENSEA ABB.051 CONDENSATE TRAY SUPPORT BLAST CHILLER 051	031 / 051	22/02/07 00/00/00	
SB	965470	SUPP.BACINELLA RACC.COND.ABB.081/121 CONDENSATE TRAY SUPPORT B.C. 081/121/161	081 / 121 / 161	_/_/_ 00/00/00	
SB1	965249	STAFFA SUPPORTO RACC.SCARICO ABB.051- 161 FRAME SUPPORT FOR JOINT DRAIN B.C. 051- 161		26/01/07 00/00/00	
SCE	965287	ASS. SCATOLA ELETTR. ABB.051 NEW ELECTRIC BOX BLAST CHILLER 051 NEW	031 / 051	_/_/_ 00/00/00	
SCE	965400	SCATOLA ELET.TRIFASE AB121-161 X FAST ELECTRIC BOX THREE-PHASE B.C. 121/161 FAST	121A / 161 FAST	_/_/_ 00/00/00	
SCE	965401	SCATOLA ELET.TRIFASE AB121-161 X PLUS ELECTRIC BOX THREE-PHASE B.C. 121/161 PLUS	121A / 161 PLUS	_/_/_ 00/00/00	
SCE	965402	SCATOLA ELET.MONOFASE AB081-121 X FAST ELECTRIC BOX MONO-PHASIC B.C. 081-121 FAST	081 / 121D FAST	_/_/_ 00/00/00	
SCE	965403	SCATOLA ELET.MONOFASE AB081-121 X PLUS ELECTRIC BOX MONO-PHASIC B.C. 081-121 PLUS	081 / 121D PLUS	_/_/_ 00/00/00	
SCE	965642	ASS.SCATOLA ELETTR.ABB BC051 ELECTRIC BOX BLAST CHILLER 051	BC051A	_/_/_ 00/00/00	
SPL	996270	INDICATORE LIQU. SGN 6S ODFXODM 014-02 LIQUID INDICATOR SGN 6S ODFXODM 014-02	031 / 051 / 081	07/09/04 00/00/00	
SPL	996271	INDICATORE LIQU. SGN10S ODFXODM 014-02 LIQUID INDICATOR SGN10S ODFXODM 014-02	121 / 161	_/_/_ 00/00/00	
SSE	965288	STAFFA DX-SX SUPP. EVAPORATORE ABB.051 RIGHT/LEFT FRAME EVAPORATOR SUPP. B.C. 051	031 / 051	_/_/_ 00/00/00	
SSE	965406	STAFFA DX SX SUPPORTO EVAP 081-121-161 RIGHT/LEFT FRAME EVAP. 081-121-161 SUPPORT	081 / 121 / 161	_/_/_ 00/00/00	
SST	965568	SCATOLA PER STAMPANTE ABB051 PRINTER BOX BLAST CHILLER 051		_/_/_ 00/00/00	
ST	996415	STAMPANTE PER SCHEDA EVCO PRINTER FOR EVCO CARD		03/11/06 00/00/00	
T	990319	TRASFORMATORE 230/24V 17VA 50/60HZ TRANSFORMER 230/24V 17VA 50/60HZ	BF	08/09/00 00/00/00	□
T2	995850	REATTORE PER NEON 15W BALLAST 15W	081 / 121 / 161	14/09/98 00/00/00	
TPS	965281	TAPPO PILETTA DI SCARICO ABS H=74 FLOOR DRAIN PLUG ABS H=74		22/02/07 00/00/00	
TS	965407	TUBO SCAMBIATORE BF051(+/-) EXCHANGER TUBE BF051 (+/-)	BF051_ / BF031A	_/_/_ 00/00/00	
TS	965408	TUBO SCAMBIATORE BC051(-) EXCHANGER TUBE BC051(-)	BC051D	_/_/_ 00/00/00	

riferim. reference	codice code	descrizione description	modello model	da...a from...to	ricambi cons. rec. spare part
TS	965529	TUBO SCAMBIATORE 161(BF+- BC+) BF122 EXCHANGER TUBE 161(BF+- BC+) BF122	BF161_ / BC161A	__/_ 00/00/00	
TS	965530	TUBO SCAMBIATORE 121(BF+) EXCHANGER TUBE 121(BF+)	BF121A	__/_ 00/00/00	
TS	965531	TUBO SCAMBIATORE 121(BF+ BC+-) EXCHANGER TUBE 121(BF+ BC+-)	BF121D / BC121D	__/_ 00/00/00	
TS	965532	TUBO SCAMBIATORE 081(BF+- BC+) EXCHANGER TUBE 081(BF+- BC+)	B_081A	__/_ 00/00/00	
TS1	996542	GUAINA SPIRALATA GRIGIA D=16 PVC AL M. GREY SPIRAL SHEATHING D=16 PVC		__/_ 00/00/00	
TS2	995512	RACCORDO DI SCARICO AP350 FLESSIBIL JOINT DRAIN AP350 FLESSIBIL	081 / 121 / 161	01/01/95 00/00/00	
TS2	996520	RACCORDO SCARICO 1'G ABB051 L=40CM JOINT DRAIN 1'G BC051 L=40CM	031 / 051	__/_ 00/00/00	
V1	995336	VALVOLA SOLENOIDE 1/4"A SALDARE 230V SOLENOID VALVE 1/4" TO SOLD 230V	051	__/_ 00/00/00	<input type="checkbox"/>
V1	995508	VALVOLA SOLENOIDE 3/8"A SALDARE 230V SOELNOID VALVE 3/8" 230V TO SOLD	081 / 121 / 161	__/_ 00/00/00	<input type="checkbox"/>
VCC	995932	ASS.VASCHETTA EVAPORA CONDENSA ABBATT. TRAY FOR CONDENSATION BLAST CHILLER		05/03/07 00/00/00	
VEC	965757	VASCHETTA R.CONDENSA ABB P700 RAL7012 EVAPORATOR TRAY CONDENS. BC P700 RAL7012	031 / 051	__/_ 00/00/00	
VEC	965758	VASCHETTA R.CONDENSA ABB P800 RAL7012 EVAPORATOR TRAY CONDENS. BC P800 RAL7012	081 / 121 / 161	__/_ 00/00/00	
VE	996206	VALVOLA TERMOSTATICA TS2 R404 A SALDARE THERMOSTATIC VALVE TS2 R404A TO SOLDER	BF031A / BF051_	18/03/03 00/00/00	
VE	996258	VALV.TES2 68Z3442 ODF -40-5 MOP 0 R4 VALVE TES2 68Z3442 ODF -40-5 MOP 0 R4	BC051_ / BC081-121-161A	07/09/04 00/00/00	
VE	996259	VALVOLA TES2 68Z3648 ODF -40-15 MOP-10 R4 VALVE TES2 68Z3648 ODF -40-15 MOP-10 R4	BF051-081-161A / BF121_	07/09/04 00/00/00	
W2	965433	KIT LAMP.UVC AB 051-081-121-161-122 RI UVC LAMP BC 051-081-121-161-122	081 / 121 / 161	__/_ 00/00/00	
W2a	995853	LAMPADA FLUORESCENTE GERMICIDA 15W FLUORESCENT GERMICIDAL LAMP 15W	081 / 121 / 161	14/09/98 00/00/00	
W2b	995852	TUBO PROTEZIONE LAMPADA GERMICIDA PROTECTIVE TUBE FOR GERMICIDAL LAMP	081 / 121 / 161	14/09/98 00/00/00	
W2c	965534	GRIGLIA PROTEZIONE LAMPADA GERMICIDA PROTECTIVE GRID FOR GERMICIDAL LAMP	081 / 121 / 161	__/_ 00/00/00	
W2d	995854	PORTALAMPADA PROTETTO X LAMPADA GERMIC BULB SOCKET FOR GERMICIDAL LAMP	081 / 121 / 161	14/09/98 00/00/00	

referim. reference	codice code	descrizione description	modello model	da...a from...to	ricambi cons. rec. spare part
W2e	965535	RACCORDO C/PRESSACAVO STAGNO X LAMP/GE PRESS-WIRE JOINT FOR GERMICIDAL LAMP	081 / 121 / 161	__/__/00 00/00/00	
XA	965525	MORSETTO PHOENIX MSTB 2,5/2-ST PAS=5 PHOENIX TERMINAL MSTB 2,5/2-ST PAS=5		__/__/00 00/00/00	
XB	965526	MORSETTO PHOENIX MSTB 2,5/3-ST PAS=5 PHOENIX TERMINAL MSTB 2,5/3-ST PAS=5		__/__/00 00/00/00	
XC	996591	MORSETTO PHOENIX MSTB 2,5/4-ST PAS=5 PHOENIX TERMINAL MSTB 2,5/4-ST PAS=5		__/__/00 00/00/00	
XH	965528	MORSETTO PHOENIX MSTB 2,5/8-ST PAS=5 PHOENIX TERMINAL MSTB 2,5/8-ST PAS=5		__/__/00 00/00/00	
Y1	996547	TERMICA MOELLER ZE 6,0 (4-6A) TELEMECANIQUE THERMAL ZE 6,0 (4-6A)	121A / 161	30/05/07 00/00/00	<input type="checkbox"/>