

Vorbereitung Cutter

Artikel-Nr. 471003 (CL/3)

Explosionszeichnung / Ersatzteile

Bitte bei Ersatzteilbestellung immer Seriennummer mit angeben!

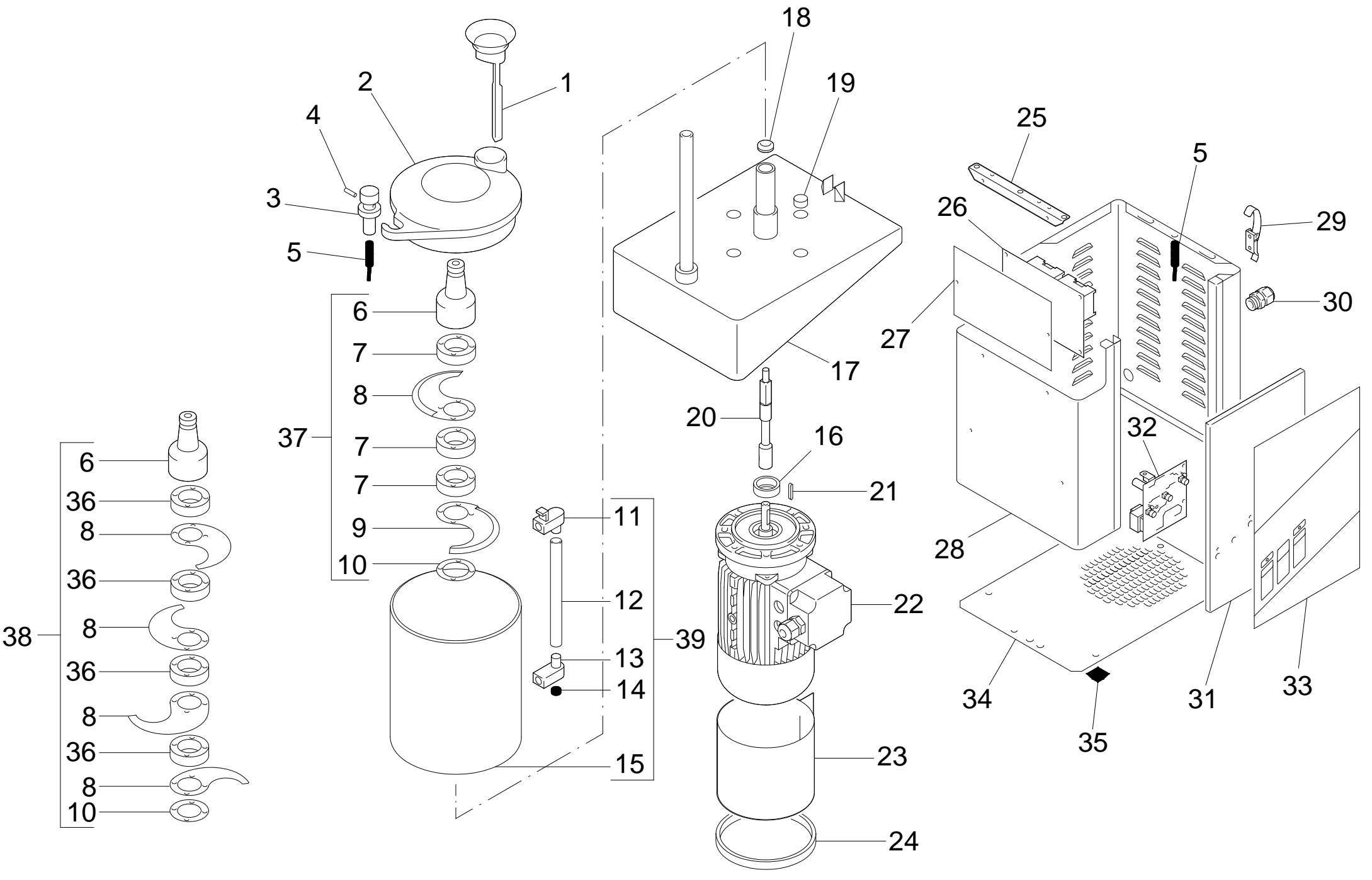

CL3-5-8

Pos. Ref.	Codice Code	Caratteristiche Features	Descrizione Description
1	SA1085	Assembly (CL3)	Tappo Tap
1	SA1086	Assembly (CL5-8)	Tappo Tap
2	36Z0665	● Assembly	Coperchio Cover
3	36D2910		Tappo Tap
4	31Z8890	∅5x15 A2	Spina Pin
5	32W3240	●	Microinterruttore Microswitch
6	36G7010		Mozzo Hub
7	36G7040	(CL3)	Anello Ring
7	36G0650	(CL5-8)	Anello Ring
8	36G7030		Lama liscia Smooth blade
8	SL2301		Lama sbattitrice Beater blade
9	SL1923		Lama liscia Smooth blade
9	SL2302		Lama sbattitrice Beater blade
10	3190070		Rosetta Washer
11	36M5350		Tappo Tap
12	35X1880		Tubo Tube
12	35X1870		Tubo Tube
12	SL1930		Tubo Tube
13	36M5620		Tappo Tap
14	3600160	●	Magnete Magnet
15	30W3110	(CL3)	Pentola Pan
15	35W0320	(CL5)	Pentola Pan
15	30W0330	(CL8)	Pentola Pan
16	SL0127	∅17x∅40x7	Paraolio Oil seal
17	6000590	Assembly (CL3)	Copertura Covering
17	6000600	Assembly (CL5)	Copertura Covering
17	6000610	Assembly (CL8)	Copertura Covering
18	3151760	V-16-S	V-ring V-ring
19	3190950		Tappo Tap
20	36G7000	(CL3)	Albero Shaft
20	36G0620	(CL5-8)	Albero Shaft
21	SL0010	5x5x20	Linguetta Key
22	SL0040	400V/3Ph/50Hz (CL3-5-8)	Motore Motor
22	SL0041	230V/1Ph/50Hz (CL3-5-8)	Motore Motor
22	32M0170	24/06/04 f.p.(*) 400V/3Ph/50Hz (CL5-8)	Motore Motor
22	32M0200	31/07/04 f.p.(*) 230V/1Ph/50Hz (CL5-8)	Motore Motor
22	SL0939	400V/3Ph/50Hz (2 speed - CL5-8)	Motore Motor
23	35D0380	(CL5-8)	Convogliatore Conveyor
24	SL1216	(CL5-8)	Guarnizione Gasket
25	35V2920		Staffa Bracket
26	SL2513	● 400V/3Ph/50Hz (CL3-5-8)	Scheda elettronica Electronic card
26	SL2512	● 230V/1Ph/50Hz (CL3-5-8)	Scheda elettronica Electronic card
26	SL2514	● 400V/3Ph/50Hz (2 speed - CL5-8)	Scheda elettronica Electronic card
26	32Z4840	15/09/03 f.p.(*)	Teleruttore Remote control switch
27	SL2783	(CL3-5-8)	Piastra Plate
27	SL2784	(2 speed - CL5-8)	Piastra Plate
27	32D0630	15/09/03 f.p.(*)	Piastra Plate
27	32D0400	15/09/03 f.p.(*)	Piastra Plate
28	35W4520	(CL3)	Carcassa Housing
28	35W4460	(CL5-8)	Carcassa Housing
29	SL1840		Maniglia Handle
30	SL0893	PG13,5	Pressacavo Cable clamp
31	35V4090	(CL3)	Copertura Covering
31	35Q9530	(CL5-8)	Copertura Covering
31	35V4100	(2 speed - CL5-8)	Copertura Covering
32	32Z6990	● (CL3-5-8)	Scheda elettronica Electronic card
32	32Z7000	● (2 speed - CL5-8)	Scheda elettronica Electronic card
33	SL3538	(CL3-5-8)	Etichetta Label
33	SL3539	(2 speed - CL5-8)	Etichetta Label
34	35M8860		Fondo Bottom
35	3178340	●	Piedino Foot
36	36G7040	(4 blades)	Anello Ring
37	COLCL3L2	Assembly (CL3) - 2 blades	Coltello liscio Smooth cutter
37	COLCL58L2	Assembly (CL5-8) - 2 blades	Coltello liscio Smooth cutter
37	COLCL3L2S	Assembly (CL3) - 2 blades	Coltello sbattitore Beater cutter
37	COLCL58L2S	Assembly (CL5-8) - 2 blades	Coltello sbattitore Beater cutter
38	COLCL58L4	Assembly (CL5-8) - 4 blades	Coltello liscio Smooth cutter
38	COLCL58L4S	Assembly (CL5-8) - 4 blades	Coltello sbattitore Beater cutter
39	51CE959	Assembly (CL3)	Pentola Pan
39	51CE964	Assembly (CL5)	Pentola Pan
39	51CE965	Assembly (CL8)	Pentola Pan

(*) : fuori produzione / out of production

● : ricambio consigliato / spare part suggested