

KROMO

**TABLE
KI4440**

**REV
02**

DISHWASHER K 80

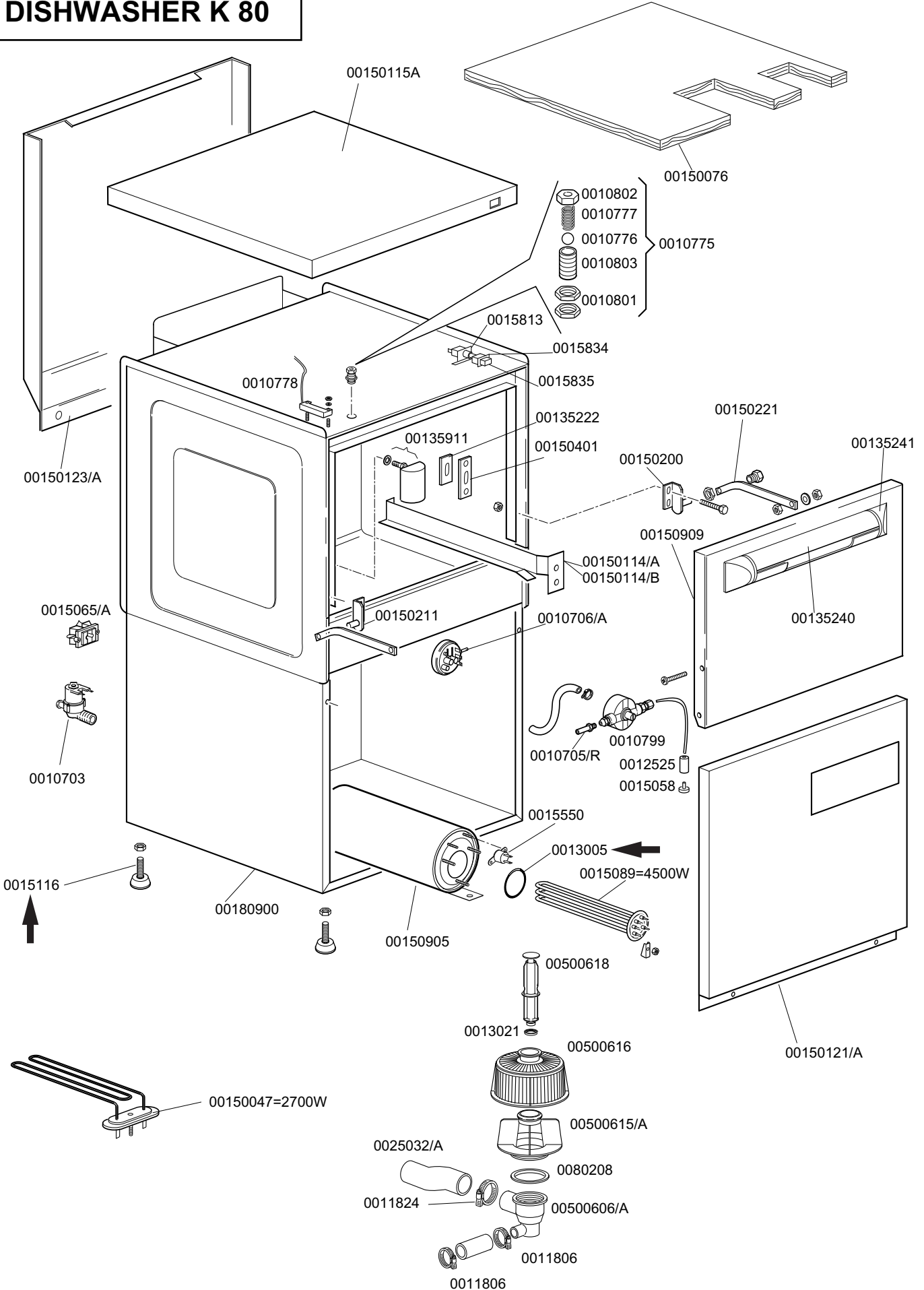

KROMO

**TABLE
KI4460**

**REV
09**

DISHWASHER K 50-80

From serial Nr.01000992 on

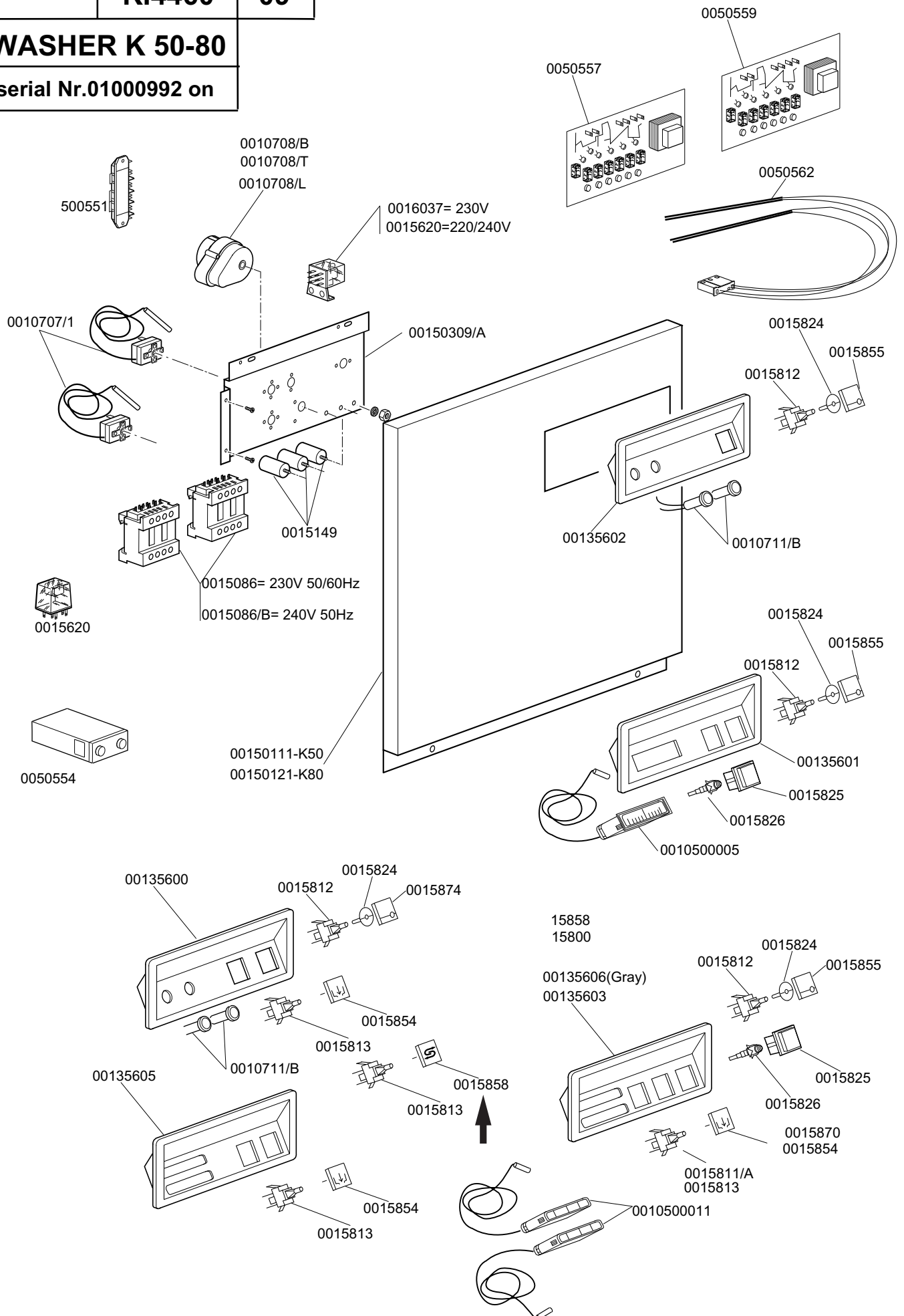

KROMO	TABLE	REV
	KI4461	00
DISHWASHER K 45-50-80		

REGENERATION / DRAIN PUMP VERSION

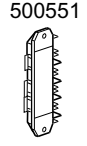
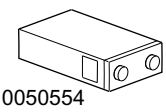
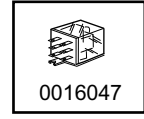

0010708/B
0010708/T
0010708/L

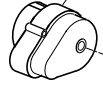

0016037= 230V
0015620=220/240V



0050557

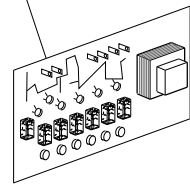

0050559

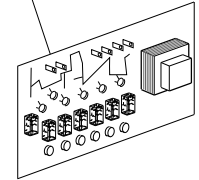

0050562

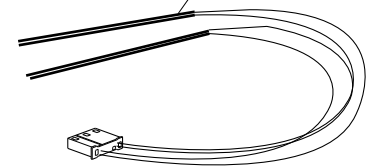

0010707/1

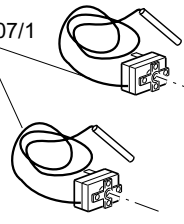

00150309/A

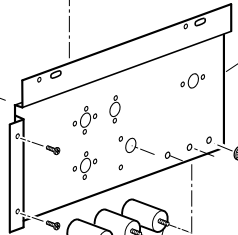

0015149

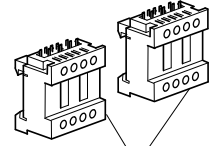

0015086= 230V 50/60Hz
0015086/B= 240V 50Hz

00150111-K50
00150121-K80

00135606/A(Gray)
00135603/A
00135616

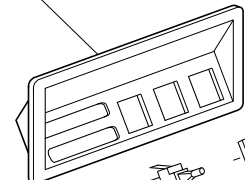

0015812 0015824 0015874

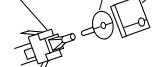

0015825

0015826

0015870
0015854

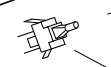

0015811/A
0015813

0015880

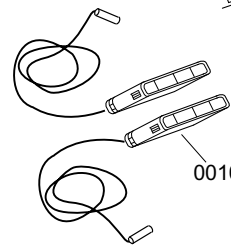

001050011

STANDARD CONTROL PANEL K-45/50/80

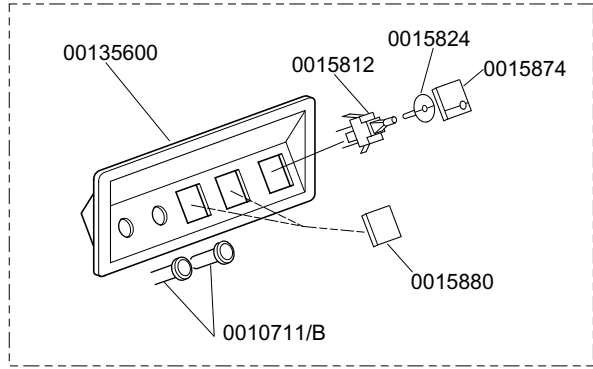

0015812 0015824 0015874

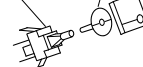

0015880

0015854 0015858

0015813

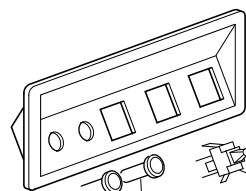

00135600

0010711/B

0015813