

SUPERLOTUS 70≤0601

ELETTRICO / ELECTRIC / ELEKTRO / ELECTRIQUE

FT..-74ET FT..-78ET FT..-712ET

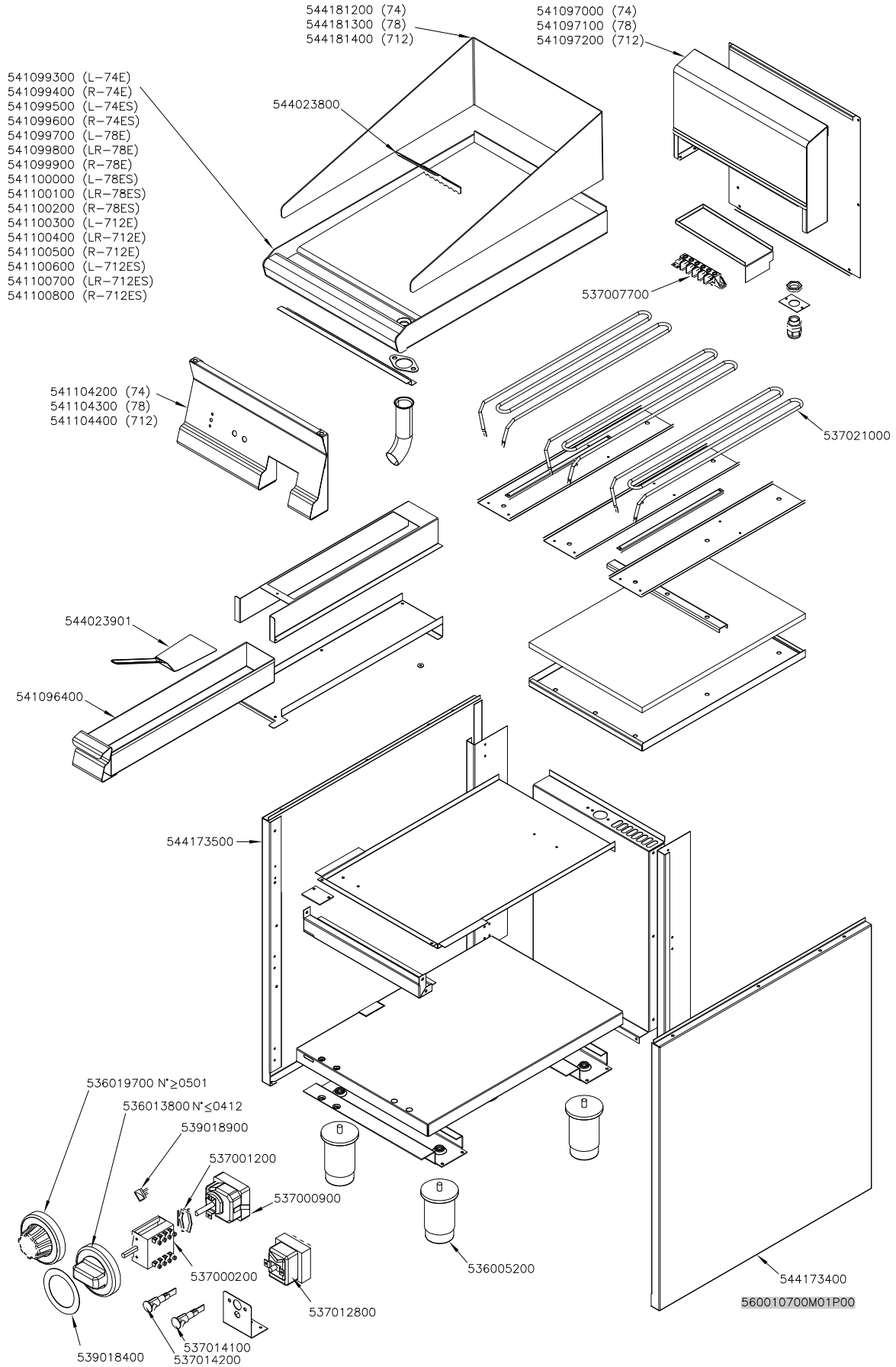

Page	Pos	Code	Description
001		544181200	SPLASH GUARD FT-74
001		541097000	NEUTRAL SPACER 74
001		544023800	
001		537007700	TERMINAL BLOCK THREEPHASE 40A
001		537021000	HEATING ELEMENT 1500W 230V FT S.70
001		541099600	UPPER PLATE FTR-74ES
001		541104200	CONTROL PANEL FT-74E
001		544023901	SPATTLE FOR FRY-TOP
001		541096400	DRIP TRAY FT S.70
001		544173500	LEFT SIDE PANEL S.70
001		536019700	BLACK KNOB §70 PIN §6*5
001		536013800	KNOB D.70 BLACK 6*5 WITH SPRING
001		539018900	INDEX FOR KNOB
001		537001200	FIXING BRACKET FOR THERMOSTAT/COMM.
001		537000900	THERMOSTAT 50-320°C THREEPHASE
001		536005200	INOX LEG 2" 120-180 M10
001		537012800	SAFETY THERMOSTAT 420°C THREEPHASE
001		537000200	COMMUTATOR 1 POS. 3PHASE S.49 16A
001		537014100	WHITE WARNING LIGHT 250V
001		537014200	GREEN WARNING LIGHT 250V
001		539018400	ADHESIVE GRADUATED DISC FOR KNOB
001		544173400	RIGHT SIDE PANEL S.70