

539018900

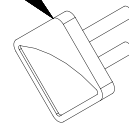

537013300

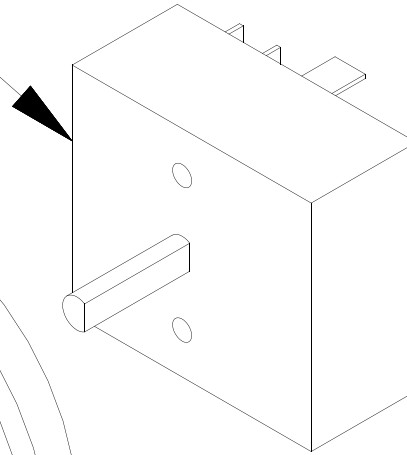

536034400

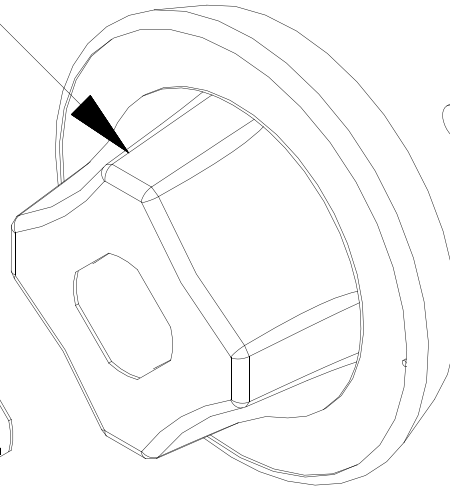

539054200

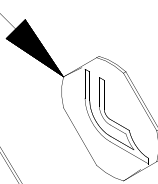

539060300

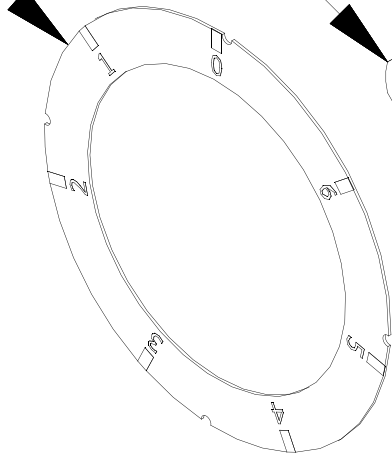

537014200

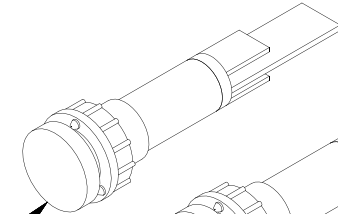

537014100

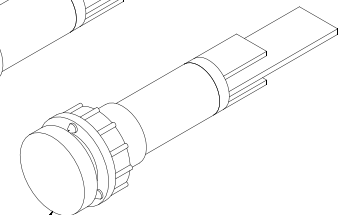

560110400M00P00

Page	Pos	Code	Description
001		541294100	COMPLETE HEAT.ELEMENT CWK98ET 1083W
001		536038700	GUARNIZIONE RESISTENZA CWK
001		533148700	IMPUGNATURA CWK
001		544739600	
001		532004100	FLUE GRID L=370 90LINE (RAF
001		531042800	SEMISPHERE FILTER
001		541283301	ASS.PIANO S90 CWK-98ET
001		533010100	3/4 D. 18 PIPE UNION
001		533010200	BICONE 18S
001		531000100	DRAIN COCK 3/4"
001		533009600	DRAIN COCK HANDLE
001		536000300	FIXED GRIP D.15*25*M6
001		537027400	TERMINAL BLOCK THREEPHASE 40A
001		544407400	LEFT SIDE PANEL 70 LINE
001		537010100	REMOTE CONTROL SWITCH 20A 230V
001		541268400	ASS.CRUSC.S607090 CWK-68E
001		544120300	DRAIN PIPE 22 FOR COCK 3/4"G
001		54440300	
001		536005200	INOX LEG 2" 120-180 M10
002		539018900	INDEX FOR KNOB W/RED SIGN
002		537013300	CURRENT REGULATOR FOR ELEC. PLATE
002		536034400	KNOB §77 4P. §06*4,6 C/M
002		539054200	STAMP Ø20,5 CR."L" LOTUS R.
002		539060300	RED ADESIVE DISK FOR PCC/PCI-E
002		537014200	GREEN WARNING LIGHT 250V
002		537014100	WHITE WARNING LIGHT 250V