

539018900

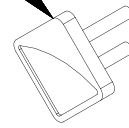

537013300

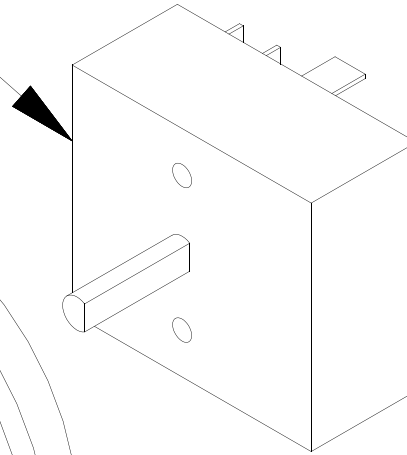

536034400

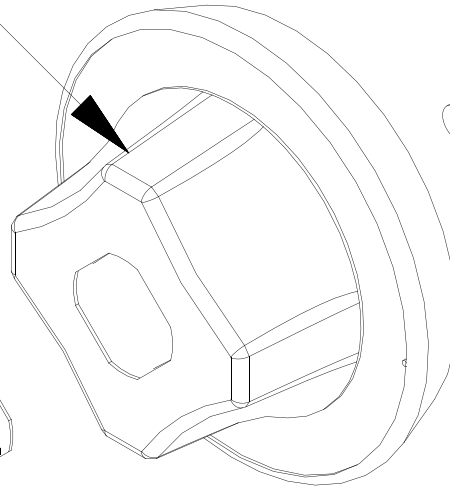

539054200

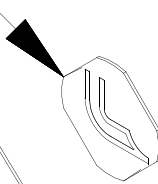

539060300

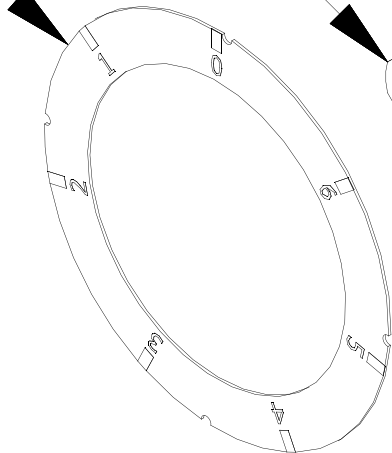

537014200

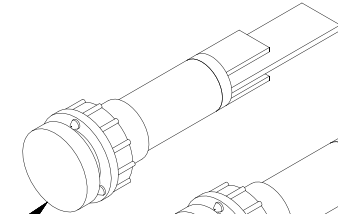

537014100

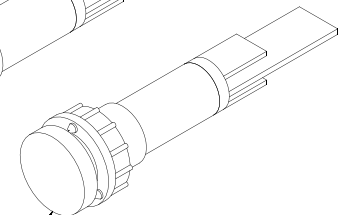

560110400M00P00

Page	Pos	Code	Description
001		536038700	GUARNIZIONE RESISTENZA CWK
001		541293900	COMPLETE HEAT.ELEMENT CWK68ET 6720W
001		544739600	
001		533148700	IMPUGNATURA CWK
001		531042800	SEMISPHERE FILTER
001		541198201	ASS.PIANO S60T CWK-68ET
001		533010100	3/4 D. 18 PIPE UNION
001		533010200	BICONE 18S
001		531000100	DRAIN COCK 3/4"
001		533009600	DRAIN COCK HANDLE
001		536000300	FIXED GRIP D.15*25*M6
001		544508100	LHD SIDE OF 60T APPLIANCES
001		537027400	TERMINAL BLOCK THREEPHASE 40A
001		537010100	REMOTE CONTROL SWITCH 20A 230V
001		541268400	ASS.CRUSC.S607090 CWK-68E
001		544508000	RHD SIDE OF 60T APPLIANCES
001		533010500	LEG M10*25 D.40
001		544120300	DRAIN PIPE 22 FOR COCK 3/4"G
002		539018900	INDEX FOR KNOB W/RED SIGN
002		537013300	CURRENT REGULATOR FOR ELEC. PLATE
002		536034400	KNOB §77 4P. §06*4,6 C/M
002		539054200	STAMP Ø20,5 CR."L" LOTUS R.
002		539060300	RED ADESIVE DISK FOR PCC/PCI-E
002		537014200	GREEN WARNING LIGHT 250V
002		537014100	WHITE WARNING LIGHT 250V