



**Pizzeria
Vitrinen**

Artikel-Nr. 554016 (VP4014Q)

Explosionszeichnung / Ersatzteile

Bitte bei Ersatzteilbestellung immer Seriennummer mit angeben!

ESPLOSI RICAMBI

VETRINE REFRIGERATE

REFRIGERATED DISPLAYS

KÜHLAUFsätze

VITRINES REFRIGEREES

INDICE

LISTA MODIFICHE	2
CODICI DEI PARTICOLARI	3
FOTO DEI PARTICOLARI	4
NOTE	5

SPARE PARTS LIST

INDEX

LIST OF MODIFICATIONS	2
ORDER NUMBERS	3
PICTURES OF THE DETAILS	4
NOTES	5

VP 4014N / Q – 4025N / Q

VP 4114N / Q – 4125N / Q

VP 4214N / Q – 4225N / Q

VP 4314N / Q – 4325N / Q

VP 3014N / Q – 3018N / Q

VP 3114N / Q – 3118N / Q

VP 3214N / Q – 3218N / Q

VP 3314N / Q – 3318N / Q

EXPLOSIONSZEICHNUNGEN

INHALT

LISTE DER ÄNDERUNGEN	2
BESTELNUMMERN DER BESTANDTEILE	3
ABBILDUNGEN DER BESTANDTEILE	4
BEMERKUNGEN	5

VUES ÉCLATÉES DE PIÈCES DETACHÉES

TABLE DES MATIERES

LISTE DES MODIFICATIONS	2
CODES DES PIÈCES DETACHÉES	3
PHOTO DES PIÈCES DETACHÉES	4
ANNOTATIONS	5

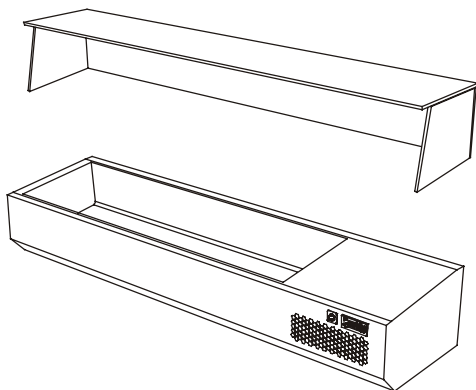

Release	Descrizione modifica	Data	Autore
08.2002	Inserito dati	29/08/2002	Polloni
01.2003	Sostituito sonda e termostato	29/01/2003	Polloni

N°	Code	Date from	Date to	I	GB	D	F	E
				UNITA' REFRIGERATA	REFRIGERATION UNIT	KÜHLMITTEL EINHEIT	GROUPE REFRIGERE	UNIDAD REFRIGERANTE
10	141565100024			COMPRESSORE ELECTROLUX GL 45 AA	COMPRESSOR ELECTROLUX GL 45 AA	KOMPRESSOR ELECTROLUX GL 45 AA	COMPRESSEUR ELECTROLUX GL 45 AA	COMPRESOR ELECTROLUX GL 45 AA
10	141565100034			COMPRESSORE ELECTROLUX GL 60 AA	COMPRESSOR ELECTROLUX GL 60 AA	KOMPRESSOR ELECTROLUX GL 60 AA	COMPRESSEUR ELECTROLUX GL 60 AA	COMPRESOR ELECTROLUX GL 60 AA
20	14353020			FILTRO	FILTER	FILTER	FILTRE	FILTRO
30	141622800013			CONDENSATORE ARIA	AIR-COOLED CONDENSER	LUFTVERFLÜSSIGER	CONDENSEUR A AIR	CONDENSADOR POR AIRE
				PARTI GENERALI	GENERAL PARTS	ALLGEMEIN TEIL	PIECES DETACHEES GENERALES	PARTES GENERALES
40	149420200			STAFFA	BRACKET	HALTEBÜGEL	ETRIER	SOPORTE
50	149420203			STAFFA	BRACKET	HALTEBÜGEL	ETRIER	SOPORTE
60	149420206			SUPPORTO	SUPPORT	HALTERUNG	SUPPORT	SOPORTE
70	149420209			VETRO LATERALE	SIDE GLASS	VETRO LATERALE	VERRE LATERAL	VIDRIO LATERAL
80	149420214			VETRO SUPERIORE 142 CM	UPPER GLASS 142 CM	VETRO SUPERIORE 142 CM	VERRE SUPERIEUR 142 CM	VIDRIO SUPERIOR 142 CM
80	149420216			VETRO SUPERIORE 160 CM	UPPER GLASS 160 CM	VETRO SUPERIORE 160 CM	VERRE SUPERIEUR 160 CM	VIDRIO SUPERIOR 160 CM
80	149420218			VETRO SUPERIORE 180 CM	UPPER GLASS 180 CM	VETRO SUPERIORE 180 CM	VERRE SUPERIEUR 180 CM	VIDRIO SUPERIOR 180 CM
80	149420220			VETRO SUPERIORE 196 CM	UPPER GLASS 196 CM	VETRO SUPERIORE 196 CM	VERRE SUPERIEUR 196 CM	VIDRIO SUPERIOR 196 CM
80	149420221			VETRO SUPERIORE 215 CM	UPPER GLASS 215 CM	VETRO SUPERIORE 215 CM	VERRE SUPERIEUR 215 CM	VIDRIO SUPERIOR 215 CM
80	149420225			VETRO SUPERIORE 250 CM	UPPER GLASS 250 CM	VETRO SUPERIORE 250 CM	VERRE SUPERIEUR 250 CM	VIDRIO SUPERIOR 250 CM
90	149420314			VETRO POSTERIORE 142 CM	BACK GLASS 142 CM	VETRO POSTERIORE 142 CM	VERRE POSTERIEUR 142 CM	VIDRIO POSTERIOR 142 CM
90	149420316			VETRO POSTERIORE 160 CM	BACK GLASS 160 CM	VETRO POSTERIORE 160 CM	VERRE POSTERIEUR 160 CM	VIDRIO POSTERIOR 160 CM
90	149420318			VETRO POSTERIORE 180 CM	BACK GLASS 180 CM	VETRO POSTERIORE 180 CM	VERRE POSTERIEUR 180 CM	VIDRIO POSTERIOR 180 CM
90	149420320			VETRO POSTERIORE 196 CM	BACK GLASS 196 CM	VETRO POSTERIORE 196 CM	VERRE POSTERIEUR 196 CM	VIDRIO POSTERIOR 196 CM
90	149420321			VETRO POSTERIORE 215 CM	BACK GLASS 215 CM	VETRO POSTERIORE 215 CM	VERRE POSTERIEUR 215 CM	VIDRIO POSTERIOR 215 CM
90	149420325			VETRO POSTERIORE 250 CM	BACK GLASS 250 CM	VETRO POSTERIORE 250 CM	VERRE POSTERIEUR 250 CM	VIDRIO POSTERIOR 250 CM
150	1467000			PIEDINO FISSO	FIXED FOOT	FESTER FUß	PIED FIXE	PATA FIJA
				TERMOSTATO	THERMOSTAT	THERMOSTAT	THERMOSTAT	TERMOSTATO
100	167215		09/02/2003	SONDA	SENSOR NTC	FÜHLER	SONDE	SONDA
100	167212	10/02/2003		SONDA	SENSOR NTC	FÜHLER	SONDE	SONDA
130	16811201		09/02/2003	TERMOSTATO	THERMOSTAT	THERMOSTAT	THERMOSTAT	TERMOSTATO
130	16814002	10/02/2003		TERMOSTATO	THERMOSTAT	THERMOSTAT	THERMOSTAT	TERMOSTATO
				COMPONENTI ELETTRICI	ELECTRIC COMPONENTS	ELEKTRISCH	COMPOSANTS ELECTRIQUES	PARTES ELECTRICAS
110	1610056			CAVO ALIMENTAZIONE	POWER CORD	SPEISEKABEL	CABLE D'ALIMENTATION	CABLE DE ALIMENTACIÓN
120	1648110155			VENTILATORE PER CELLA	COLD ROOM FAN	ZELLENLÜFTER	VENTILATEUR POUR CHAMBRE	VENTILADOR PARA CÁMARA
140	1635110			INTERRUTTORE AD ALTA LUMINOSITÀ	HIGH-BRIGHTNESS SWITCH	HELLEUCHT-SCHALTER	INTERRUPTEUR A HAUTE INTENSITE LUMINEUSE	INTERRUPTOR DE ALTA LUMINOSIDAD

