

RIVER 152

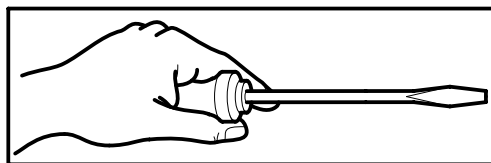

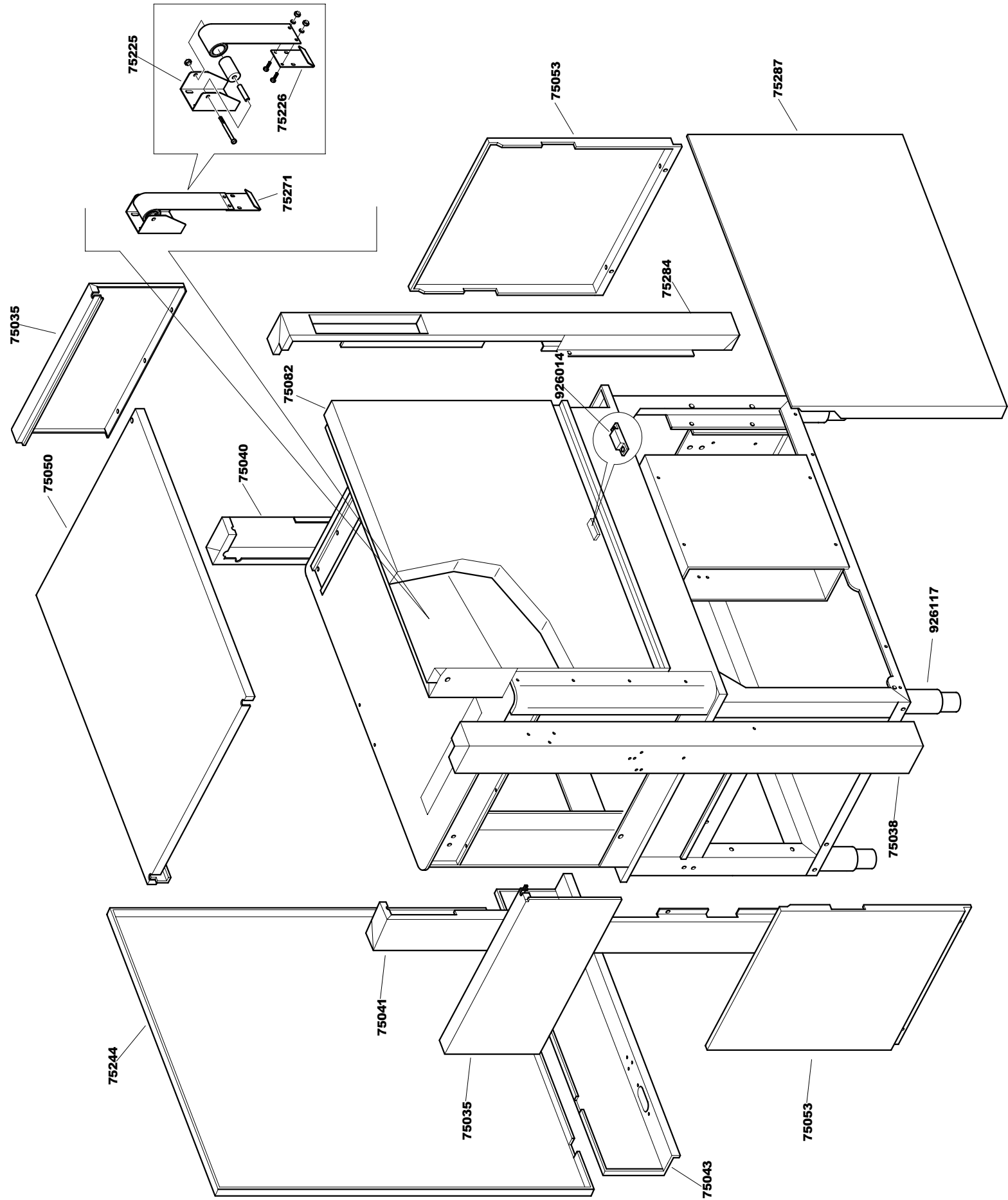

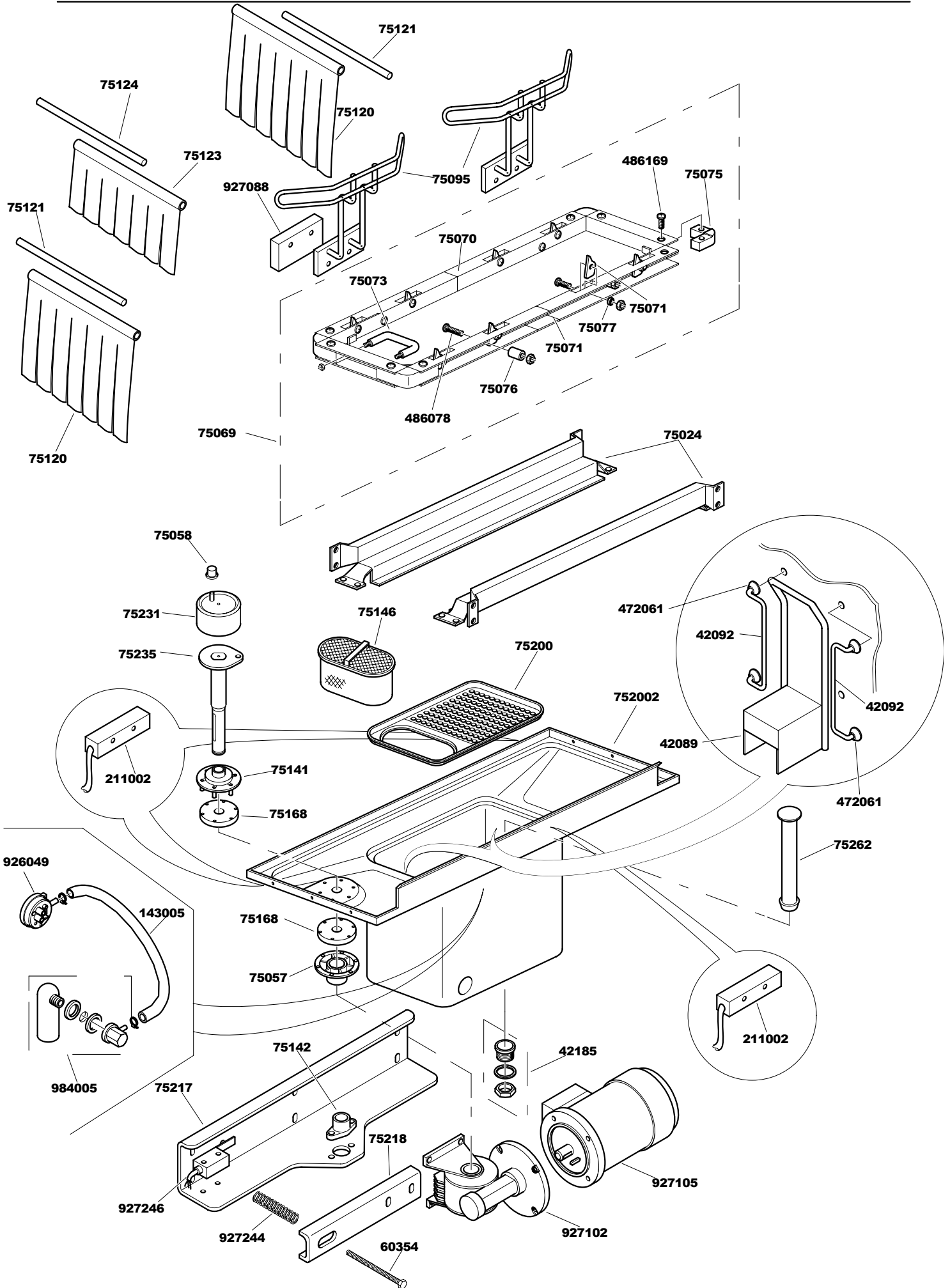

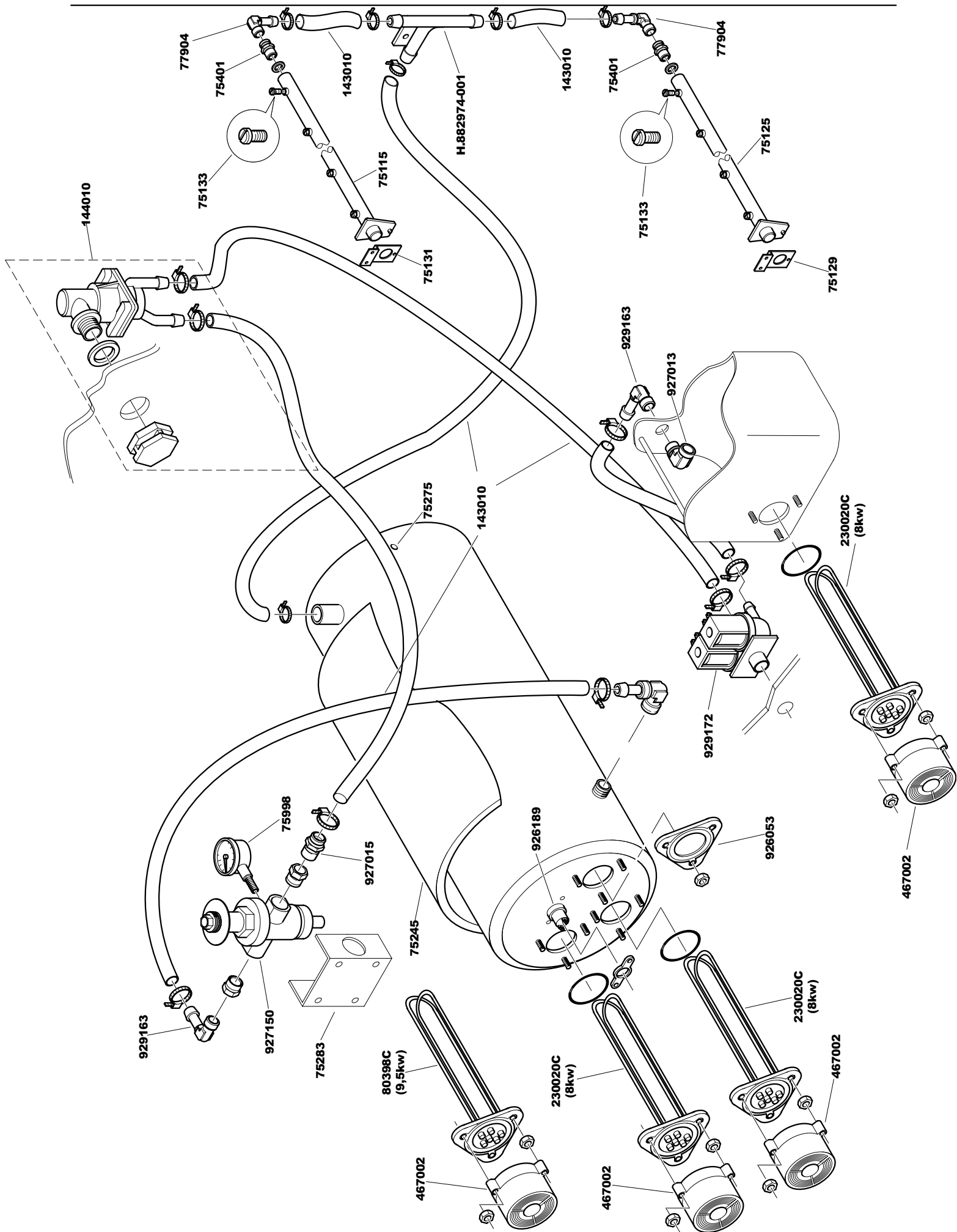

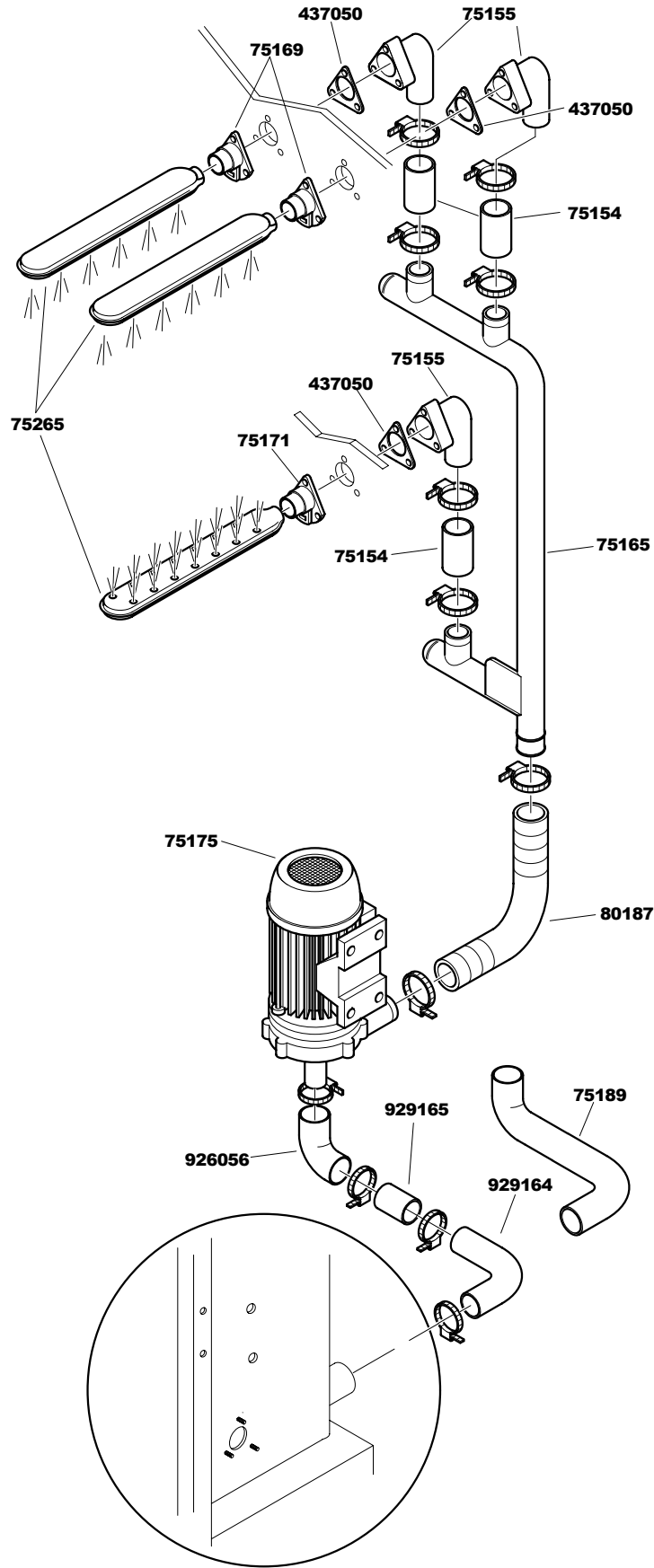

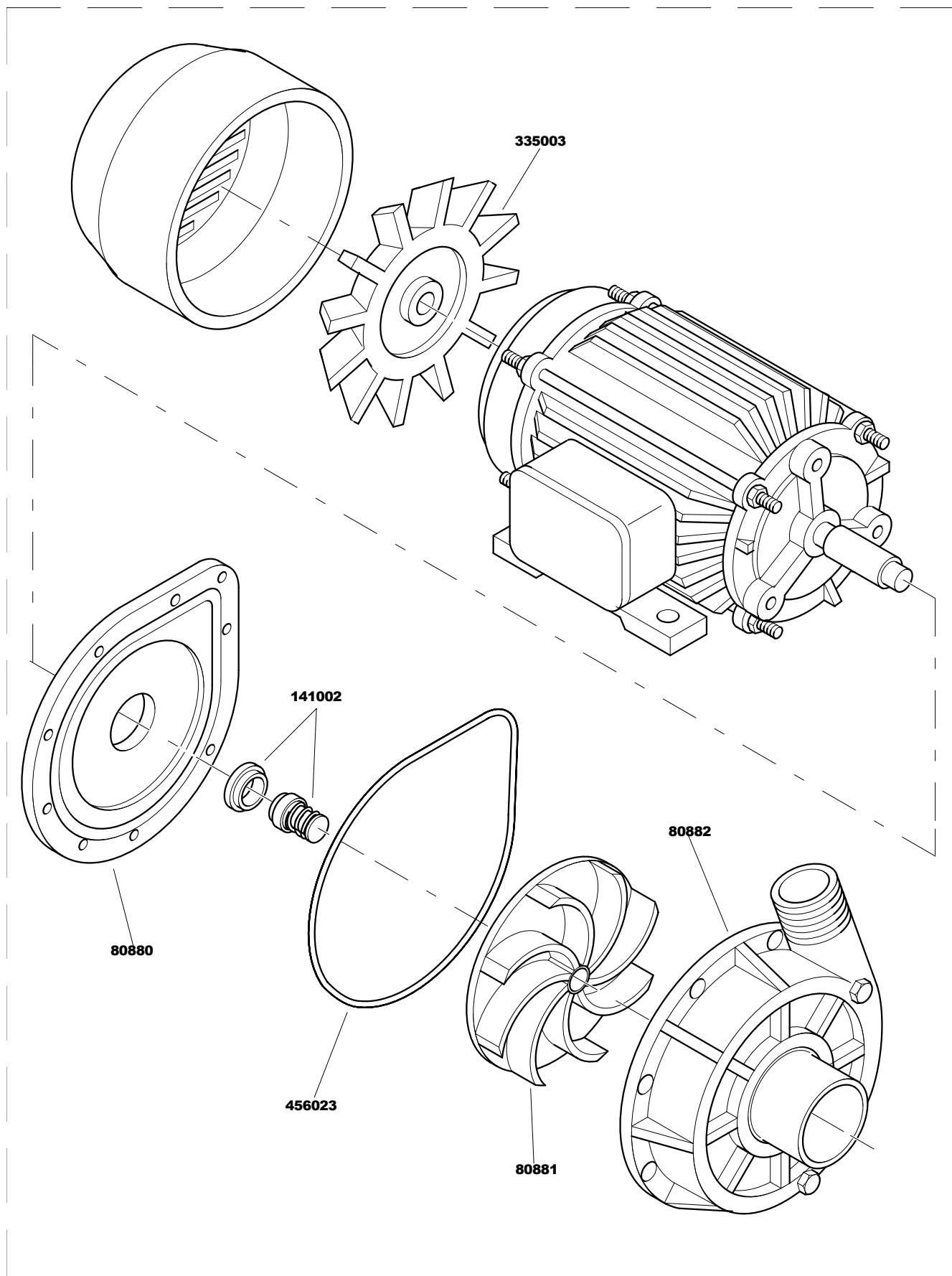

75175