

SUPERLOTUS 70 TOP

ELETTRICO / ELECTRIC / ELEKTRO / ELECTRIQUE

FTT...-74ET FTT...-76ET FTT...-78ET

- 541099300 (L-74E)
- 541099400 (R-74E)
- 541099500 (L-74ES)
- 541099600 (R-74ES)
- 541135600 (L-76E)
- 541135700 (LR-76E)
- 541135800 (R-76E)
- 541135900 (L-76ES)
- 541136000 (LR-76ES)
- 541136100 (R-76ES)
- 541099700 (L-78E)
- 541099800 (LR-78E)
- 541099900 (R-78E)
- 541100000 (L-78ES)
- 541100100 (LR-78ES)
- 541100200 (R-78ES)

- 541134000 (74)
- 541135500 (76)
- 541134200 (78)
- 544181201 (74)
- 544117001 (76)
- 544181301 (78)

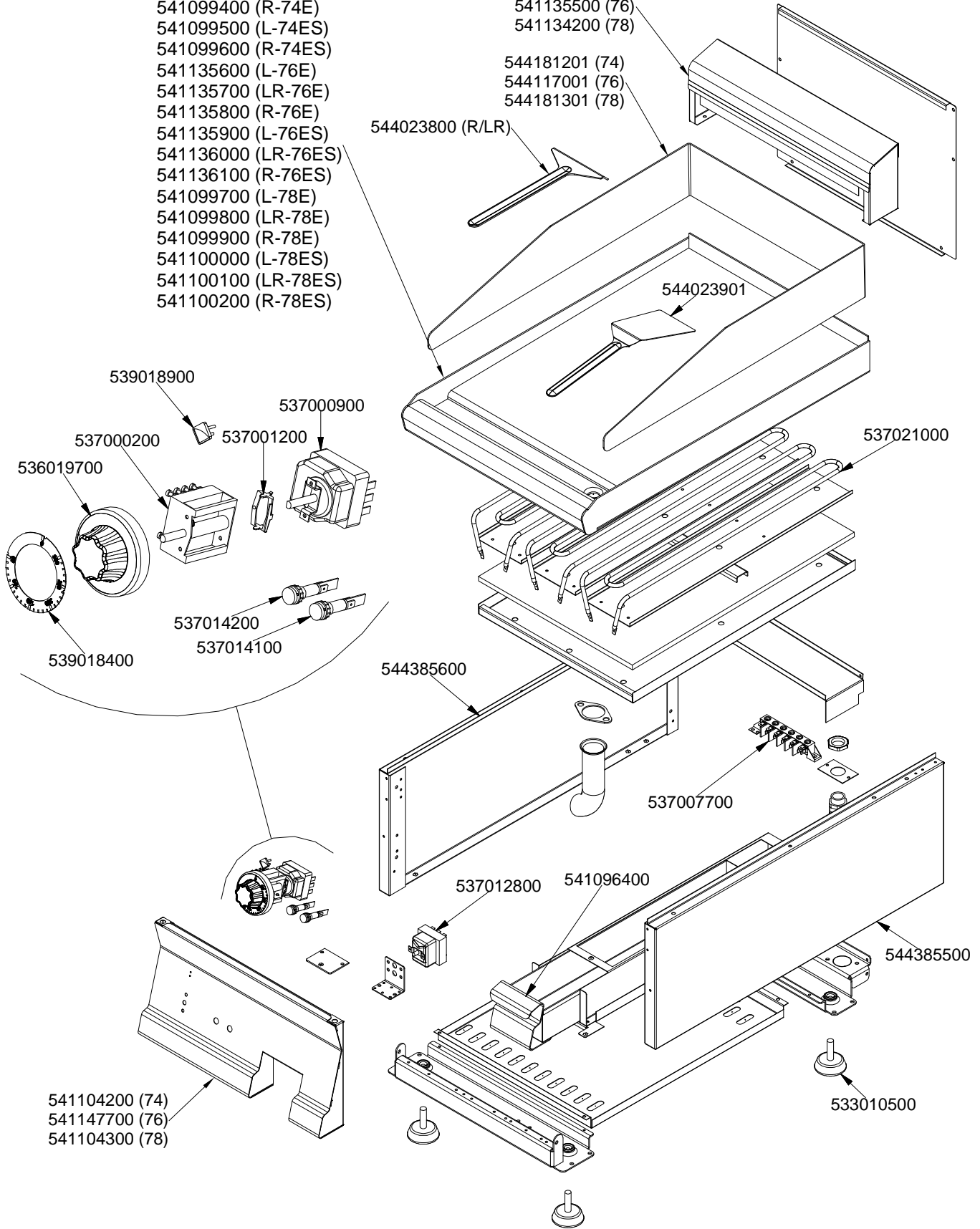

560040800M00P00

Page	Pos	Code	Description
001		541100200	UPPER PLATE FTR-78ES
001		541134200	NEUTRAL LOW SPACER 78
001		544023800	
001		544023901	SPATTLE FOR FRY-TOP
001		537021000	HEATING ELEMENT 1500W 230V FT S.70
001		539018900	INDEX FOR KNOB
001		537000900	THERMOSTAT 50-320°C THREEPHASE
001		537001200	FIXING BRACKET FOR THERMOSTAT/COMM.
001		537000200	COMMUTATOR 1 POS. 3PHASE S.49 16A
001		536019700	BLACK KNOB §70 PIN §6*5
001		539018400	ADHESIVE GRADUATED DISC FOR KNOB
001		537014200	GREEN WARNING LIGHT 250V
001		537014100	WHITE WARNING LIGHT 250V
001		544385600	LEFT SIDE OF 70T LINE
001		537007700	TERMINAL BLOCK THREEPHASE 40A
001		541096400	DRIP TRAY FT S.70
001		537012800	SAFETY THERMOSTAT 420°C THREEPHASE
001		544385500	RIGHT SIDE OF 70T LINE
001		533010500	LEG M10*25 D.40
001		541104300	CONTROL PANEL FT-78E
001		544181301	SPLASH GUARD FT-78