

539018900

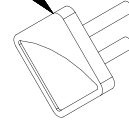

537013300

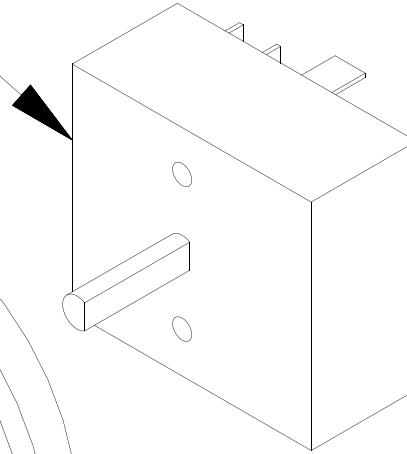

536034400

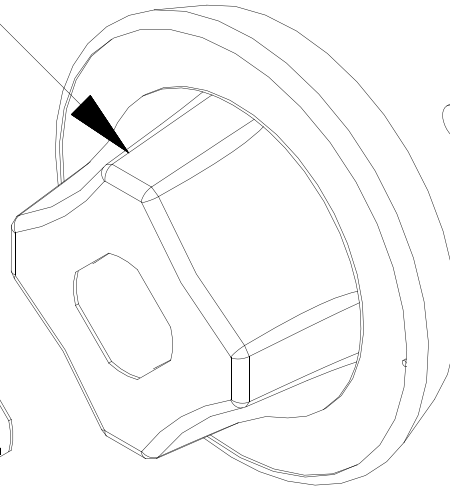

539054200

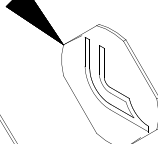

539060300

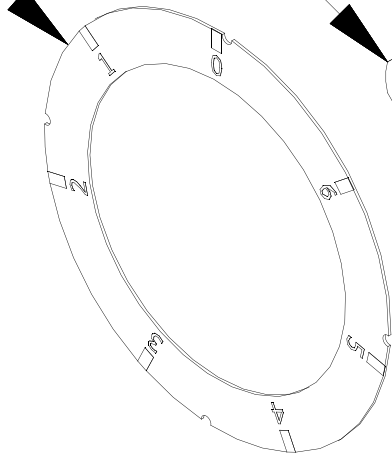

537014200

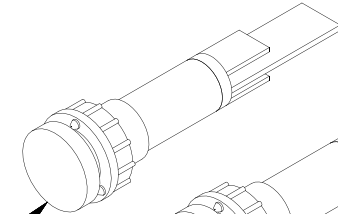

537014100

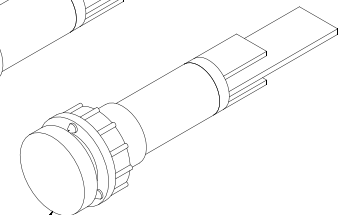

560110400M00P00

Page	Pos	Code	Description
001		541293600	ASS.RES.CWK-64 3360W 400V C/S
001		536038700	GUARNIZIONE RESISTENZA CWK
001		544739600	
001		533148700	IMPUGNATURA CWK
001		531042800	SEMISPHERE FILTER
001		541198101	ASS.PIANO S60T CWK-64ET
001		533010100	3/4 D. 18 PIPE UNION
001		533010200	BICONE 18S
001		531000100	DRAIN COCK 3/4"
001		533009600	DRAIN COCK HANDLE
001		536000300	FIXED GRIP D.15*25*M6
001		544508100	LHD SIDE OF 60T APPLIANCES
001		537027400	TERMINAL BLOCK THREEPHASE 40A
001		537010100	REMOTE CONTROL SWITCH 20A 230V
001		541139100	CONTROL PANEL S70/90 BMT-74/94E CP
001		544508000	RHD SIDE OF 60T APPLIANCES
001		533010500	LEG M10*25 D.40
001		544120300	DRAIN PIPE 22 FOR COCK 3/4"G
002		539018900	INDEX FOR KNOB W/RED SIGN
002		537013300	CURRENT REGULATOR FOR ELEC. PLATE
002		536034400	KNOB §77 4P. §06*4,6 C/M
002		539054200	STAMP Ø20,5 CR."L" LOTUS R.
002		539060300	RED ADESIVE DISK FOR PCC/PCI-E
002		537014200	GREEN WARNING LIGHT 250V
002		537014100	WHITE WARNING LIGHT 250V