

- 541099301 (L-74E)
- 541099401 (R-74E)
- 541099501 (L-74ES)
- 541099601 (R-74ES)
- 541135601 (L-76E)
- 541135701 (LR-76E)
- 541135801 (R-76E)
- 541135901 (L-76ES)
- 541136001 (LR-76ES)
- 541136101 (R-76ES)
- 541099701 (L-78E)
- 541099801 (LR-78E)
- 541099901 (R-78E)
- 541100001 (L-78ES)
- 541100101 (LR-78ES)
- 541100201 (R-78ES)
- 541100301 (L-712E)
- 541100401 (LR-712E)
- 541100501 (R-712E)
- 541100601 (L-712ES)
- 541100701 (LR-712ES)
- 541100801 (R-712ES)

- 541134000 (74)
- 541135500 (76)
- 541134200 (78)
- 541134800 (712)

544023800 (R/LR)

544023901

- 544181201 (74)
- 544117001 (76)
- 544181301 (78)
- 544181401 (712)

- 537021000 (400V3N 400V3) ≤14090676
- 537021001 (400V3N 400V3) ≥14090677
- 537046600 (440V3) ≤14090676
- 537046601 (440V3) ≥14090677
- 537046500 (FT...-76/712 400V3) ≤14090676
- 537046501 (FT...-76/712 400V3) ≥14090677

537035400 (X)

537027400

537012800

1

544173500

537036500

- 541104200 (74)
- 541147700 (76)
- 541104300 (78)
- 541104400 (712)

541096400

544173400

536005200

531015900 (X)

560010701M02P00

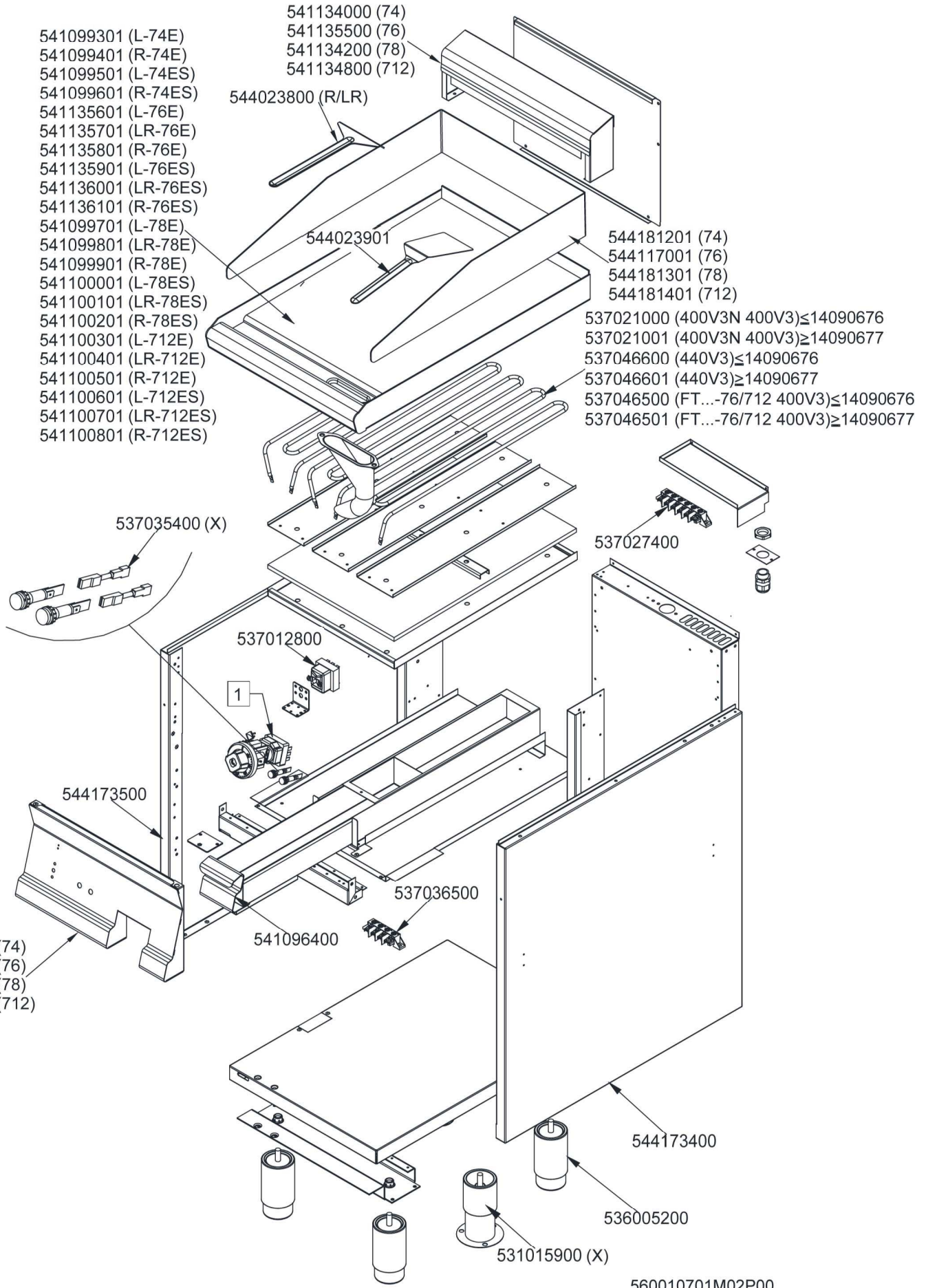

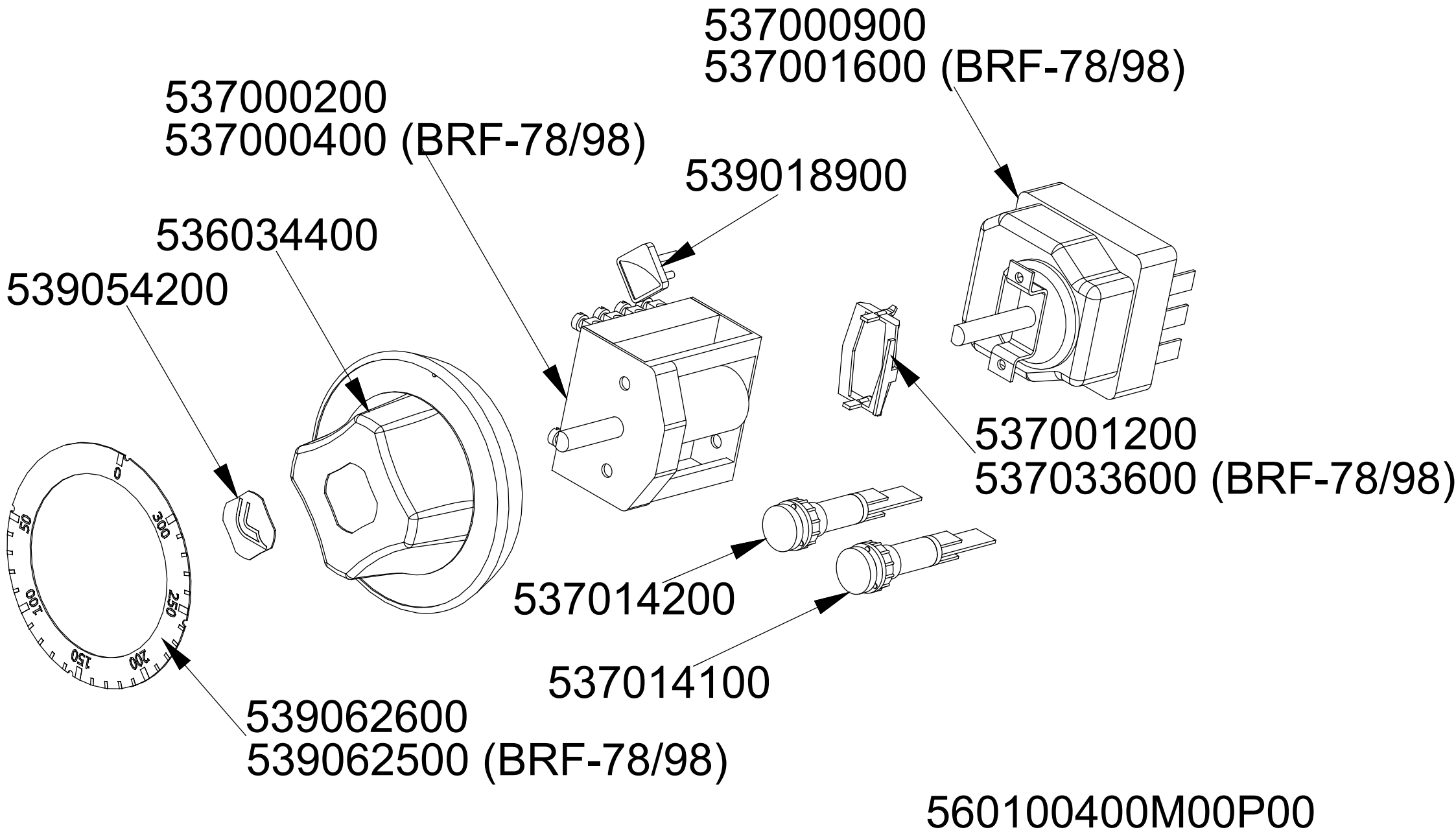

Page	Pos	Code	Description
001		541134000	NEUTRAL LOW SPACER 74
001		541099301	UPPER PLATE S70 FTL-74E (RIC
001		541099501	UPPER PLATE S70 FTL-74ES (RIC
001		544023901	SPATTLE FOR FRY-TOP
001		544181201	SPLASH GUARD FT-74
001		537021000	HEATING ELEMENT 1500W 230V FT S.70
001		547021001	
001		537046600	HEATING ELEMENT S70 1500W 440V
001		537046601	RES.COR.FT S70 1850W 1-440V
001		537035400	HEATING ELEMENT 00003W 330KOHM W/F
001		537027400	TERMINAL BLOCK THREEPHASE 40A
001		537012800	SAFETY THERMOSTAT 420°C THREEPHASE
001		544173500	LEFT SIDE PANEL S.70
001		537036500	TERMINAL BLOCK 4POLES 40A SCREW-SCR
001		541096400	DRIP TRAY FT S.70
001		541104200	CONTROL PANEL FT-74E
001		544173400	RIGHT SIDE PANEL S.70
001		531015900	ADJUSTABLE LEG 2"
002		537000900	THERMOSTAT 063-320°C THREEPHASE
002		537001600	THERMOSTAT 50-320°C SINGLEPHASE
002		537000200	COMMUTATOR 1 POS. 3PHASE S.49 16A
002		537000400	COMMUTATOR 1POS.SINGLEPHASE S49 16A
002		539018900	INDEX FOR KNOB W/RED SIGN
002		536034400	KNOB §77 4P. §06*4,6 C/M
002		539054200	STAMP Ø20,5 CR."L" LOTUS R.
002		537001200	FIXING BRACKET FOR THERMOSTAT/COMM.
002		537033600	FIXING BRACKET FOR THERMOSTAT/COMM.
002		537014200	GREEN WARNING LIGHT 250V
002		537014100	WHITE WARNING LIGHT 250V
002		539062600	RED STICKING DISK 72 (050,300°
002		539062500	RED STICKING DISK 72 (050,300°