



MUSTER 1500 SPLIT

LIST OF THE EXPLODED VIEWS



SHELL ASSY

EVAPORATOR

PUMP

ELECTRIC PARTS

Rev. 1 - 02/04/2009

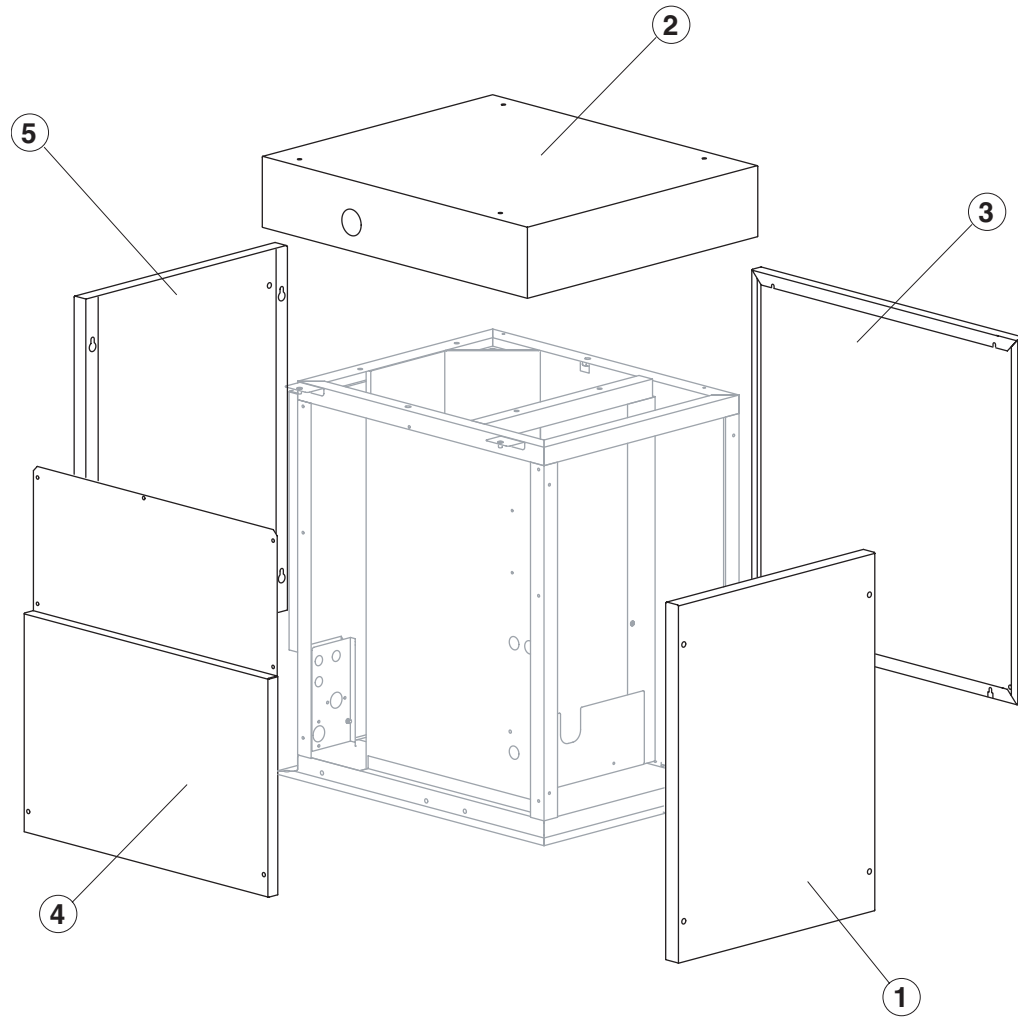

<i>Ref.</i>	<i>Spare Description</i>	<i>Code</i>
1	Front Panel	C221064B
2	Top Assembly	C22966
3	Right Side Panel	221066
4	Left Side Panel	221065
5	Rear Panel	221067



MUSTER 1500 SPLIT

EVAPORATOR

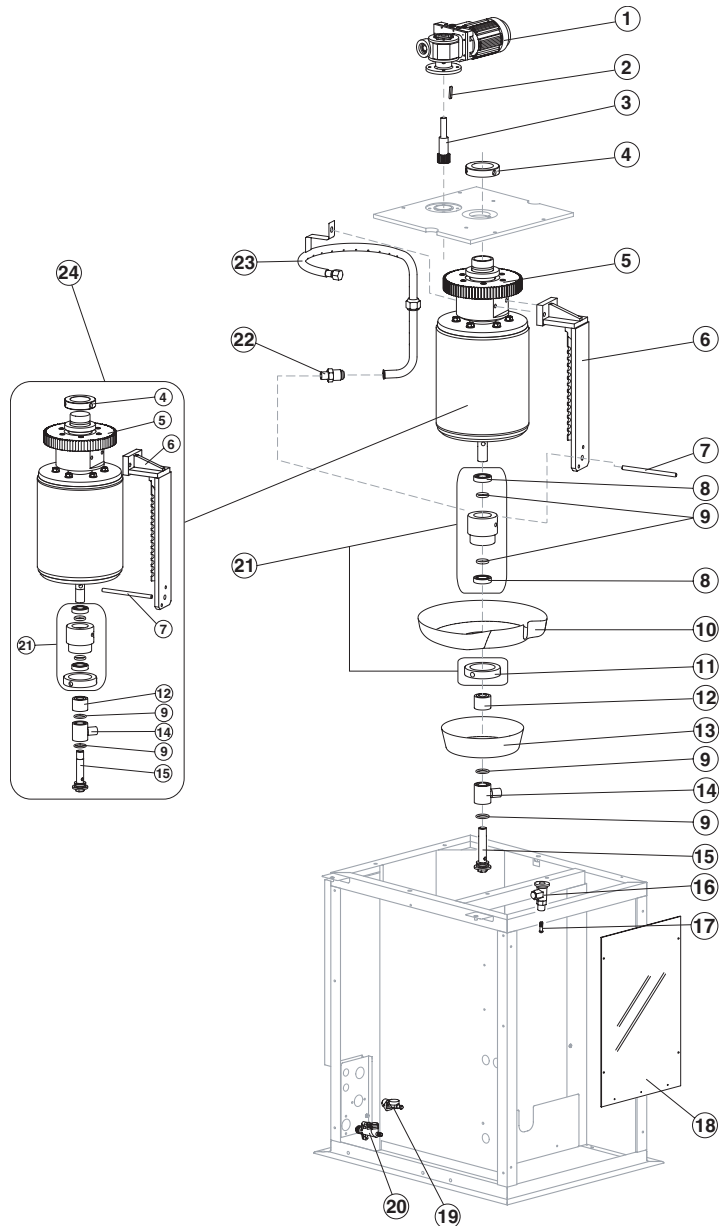

Ref.	Spare Description	Code
1	Gearmotor Assy	C23412
2	Key 6x6x40	20350
3	Pinion with Shaft for Gearmotor	C20344
4	Cylinder Locking Ring Nut	20365
5	Ring Gear	20363
6	Scraper	20873
7	M10 Tie Rod (to Block Scraper)	20874
8	Stainless Steel Bearing	20045
9	Silicone OR 4081 in Ring	20338
10	Rotating Basin	10191
11	Ring Nut for Rotating Ring	10194
12	Spacer	10528
13	Fixed Basin	C10192
14	Water Inlet Ring	20851
15	Screw	20872
16	Expansion Valve	20826
17	Orifice	20833
18	Evaporator Chamber Shield	10536
19	1 Way- Water Inlet Nipple	10368
20	Discharge Manifold	C10384
21	Complete Rotating Ring	C10193
22	Joint	20367
23	Sprayer Ring	C20882
24	Evaporator	C20877

Rev. 1 - 02/04/2009



MUSTER 1500 SPLIT

PUMP

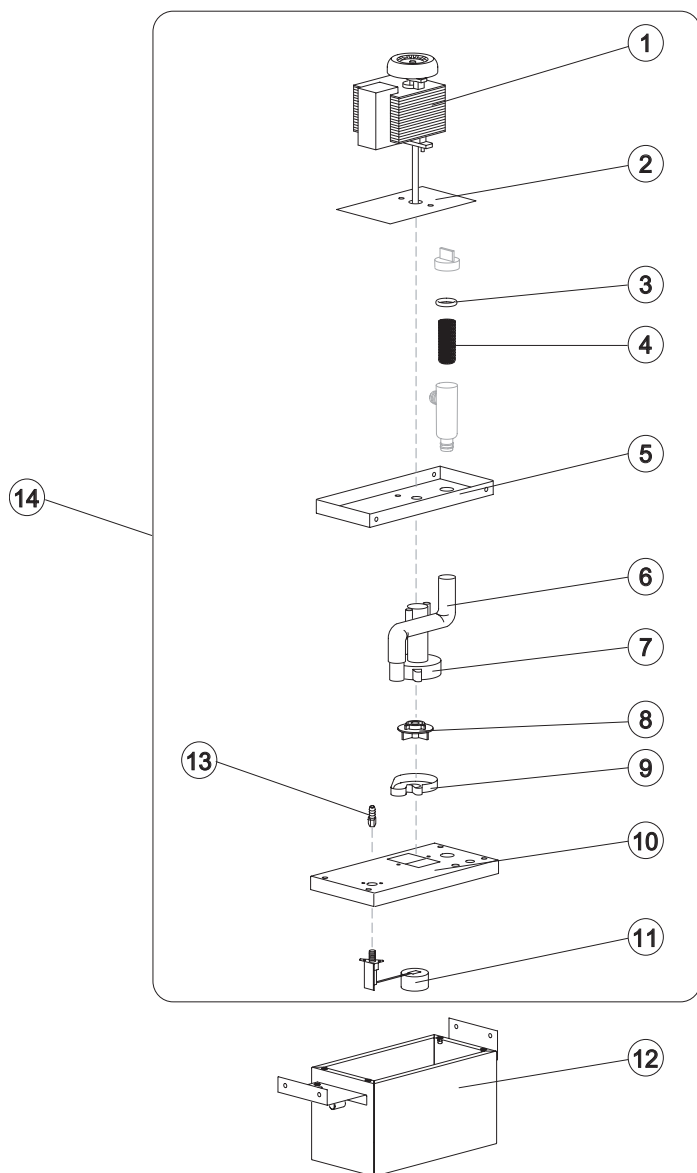

Rif.	Descrizione Ricambio	Codice
1	Pump	23600
2	Heat Dissipator	22430
3	Pump Filter Gasket	13080
4	Filtering Element	20254
5	Pump Motor Support	10161
6	Pump-Filter Connection Pipe	13084
7	Pump Body	10065
8	Pump Impeller	10066
9	Diffusor	10067
10	Water Pump Basin Cover	22420
11	Floating Valve	10188
12	Water Pump Basin	C22443
13	Connection	20799
14	Pump and Filter Assy	C26732

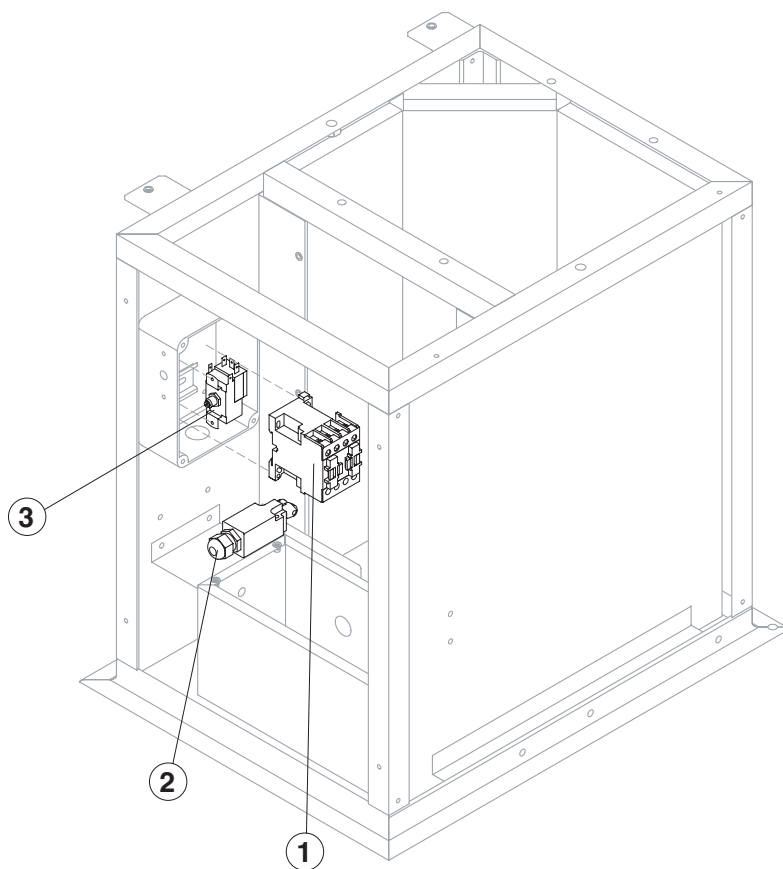

Ref.	Spare Description	Code
1	Contactot	23594
2	Microswitch for Overflow Ice	23746
3	Bin Thermostat	R23005