

MAGICLOTUS 60

CUCINE / RANGES / HERDE / CUISINIÈRES

FTT..-64G FTT..-66G FTT..-68G FTT..-610G

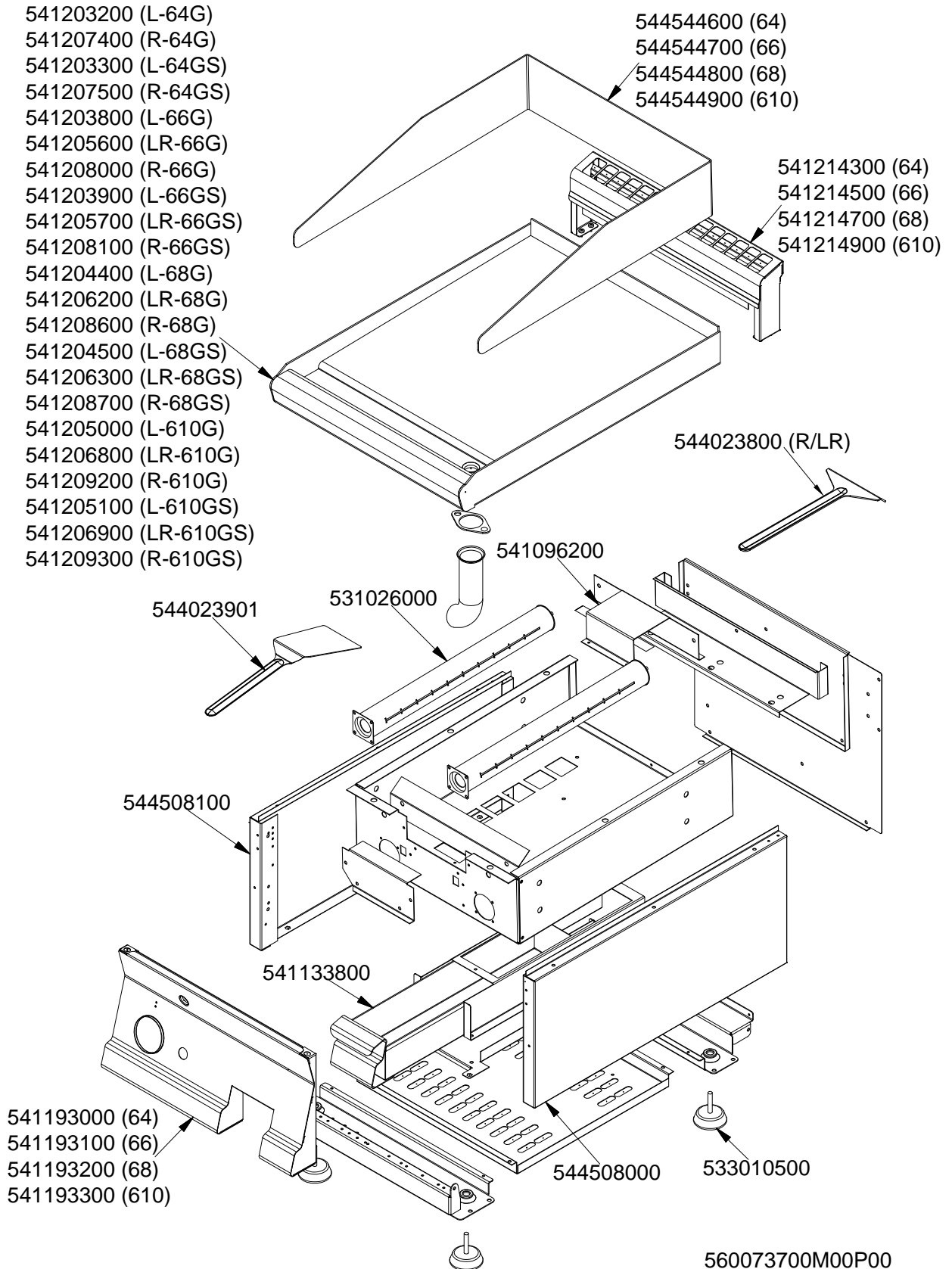

MAGICLOTUS 60

CUCINE / RANGES / HERDE / CUISINIÈRES

FTT...-64G FTT...-66G FTT...-68G FTT...-610G

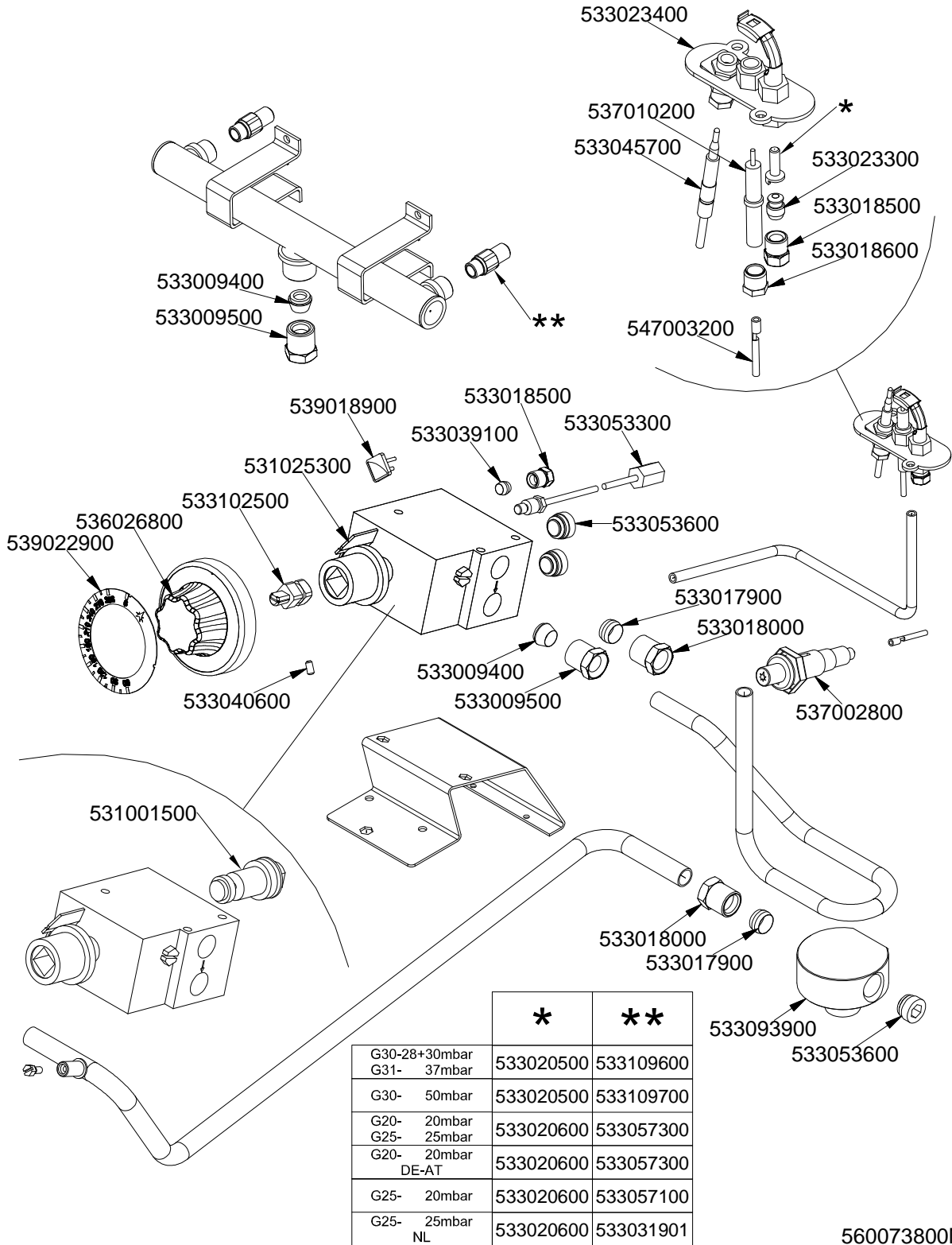

560073800M00P00

Page	Pos	Code	Description
001		541206200	UPPER PLATE FOR FTLRT-6 8G
001		544544800	SPLASH GUARD FT-6 8
001		541214700	SPACER 68G
001		544023800	
001		541096200	BURNER SUPPORT FT-74G FT-78G
001		531026000	BURNER FT-4/6/8G BM-4G
001		544023901	SPATTLE FOR FRY-TOP
001		544508100	
001		541133800	DRIP TRAY FT-55
001		533010500	LEG M10*25 D.40
001		544508000	
001		541193200	CONTROL PANEL 607090 FTT-6 8G
002		533023400	"TARGET" PILOT + NIPPLE TC
002		537010200	ROUND PLUG §2,4 - SHORT ELECTRODE
002		533045700	THERMOCOUPLE M9*1 500
002		533023300	BICONE §6 ("TARGET" PILOT)
002		533018500	FITTING FOR BICONE D.6 M10*1
002		533018600	PLUG FITTING
002		547003200	HIGH-VOLTAGE CABLE TUBE.§2 L=500
002		533009400	BICONE 10S
002		533009500	NIPPLE FOR BICONE 10S
002		539018900	INDEX FOR KNOB
002		533039100	BICONE §6
002		531025300	VALVE EUROSIT FT 100-340°C
002		533102500	
002		536026800	BLACK KNOB §70 8 P.Ø08X6,5 FR.Ø3
002		539022900	ADHESIVE GRADUATED DISC FOR KNOB
002		533053300	THERMOCOUPLE EXTENSION M9*1
002		533053600	EUROSIT VALVE PLUG
002		533017900	BICONE D.12
002		533018000	ELBOW FOR BICONE D.12 3/8 RS L20
002		537002800	PIEZOELECTRIC IGNITION M18
002		531001500	MAGNET FOR EUROSIT VALVE
002		533040600	HEADLESS SCREW M4*8
002		533093900	FITTING GAS ENTRY 1/2G 2OUT 3/8G
002		533020500	NOZZLE 0.140 §19
002		533109600	NOZZLE §083 CH12X30,0
002		533109700	NOZZLE §072 CH12X30,0
002		533020600	NOZZLE 0.140 §27
002		533057300	NOZZLE §125 CH12*30 M-FT6
002		533057100	NOZZLE §140A CH12*30 M-FT4/6/8
002		533031901	NOZZLE §130 CH12*30 MH-FT34