

1

532004100

544446900

537027400

541103900 (94)
541104000 (98)
541104100 (912)
541100600 (916)

54446800

533010500

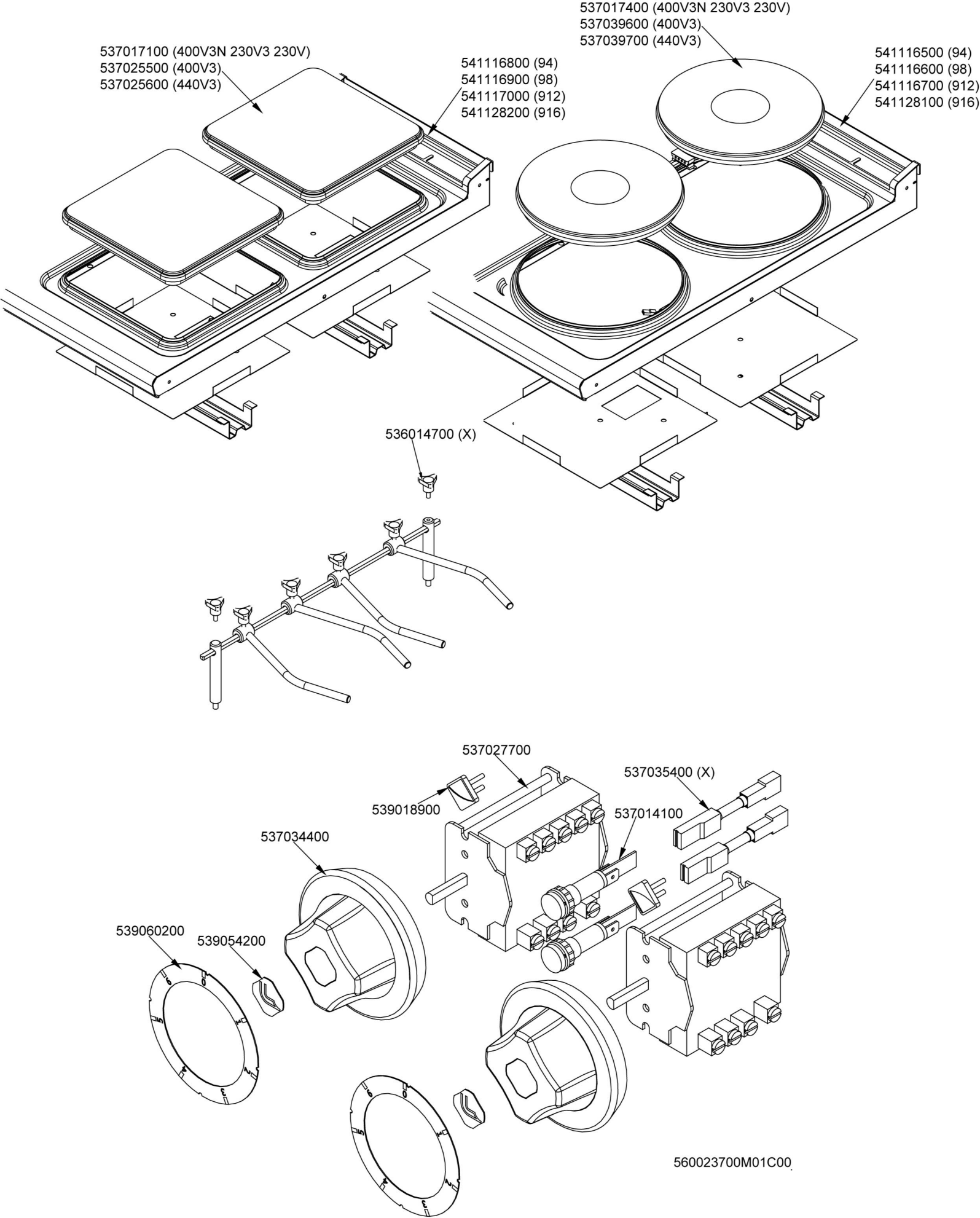

Page	Pos	Code	Description
001		532004100	FLUE GRID L=370 90LINE (RAF
001		544446900	LHD SIDE FOR 90T APPLIANCES
001		537027400	TERMINAL BLOCK THREEPHASE 40A
001		541100600	UPPER PLATE FTL-712ES
001		544446800	
001		533010500	LEG M10*25 D.40
002		541116500	UPPER PLATE PC-94E
002		541116600	UPPER PLATE PC-98E CF4-98ET
002		541116700	UPPER PLATE PC-912ET CF6-912ET/ETV
002		541128100	UPPER PLATE PC-916ET
002		537017400	ELECTRICAL PLATE D.300 W3500 V230
002		537039600	ELECTRICAL PLATE D.300 W3500 V400
002		537039700	ELECTRICAL PLATE D.300 W3500 V440
002		541116800	UPPER PLATE PCQ-94E
002		541116900	UPPER PLATE PCQ-98E CFQ4-98ET
002		541117000	UPPER PLATE PCQ-912E CFQ6-912ET/ETV
002		541128200	UPPER PLATE PCQ-916ET
002		537017100	PLATE 300X300 W4000 V230
002		537025500	PLATE 300X300 W4000 V400
002		537025600	PLATE 300X300 W4000 V440
002		536014700	3 DRILL WHEELS
002		537035400	HEATING ELEMENT 00003W 330KOHM W/F
002		537014100	WHITE WARNING LIGHT 250V
002		537027700	COMMUTATOR 7 POSITIONS S.43 32A
002		539018900	INDEX FOR KNOB W/RED SIGN
002		537034400	HEATING EL. 470X270 9500W230V
002		539054200	STAMP Ø20,5 CR."L" LOTUS R.
002		539060200	RED ADESIVE DISK FOR PC-E