

**Kühlung  
Büfett-Inseln, Service-Counter**

Artikel-Nr. 656006 (BM-C 180 S/S)

---

**Explosionszeichnung / Ersatzteile**

---

Bitte bei Ersatzteilbestellung immer Seriennummer mit angeben!

# BAIN MARIE BM-C

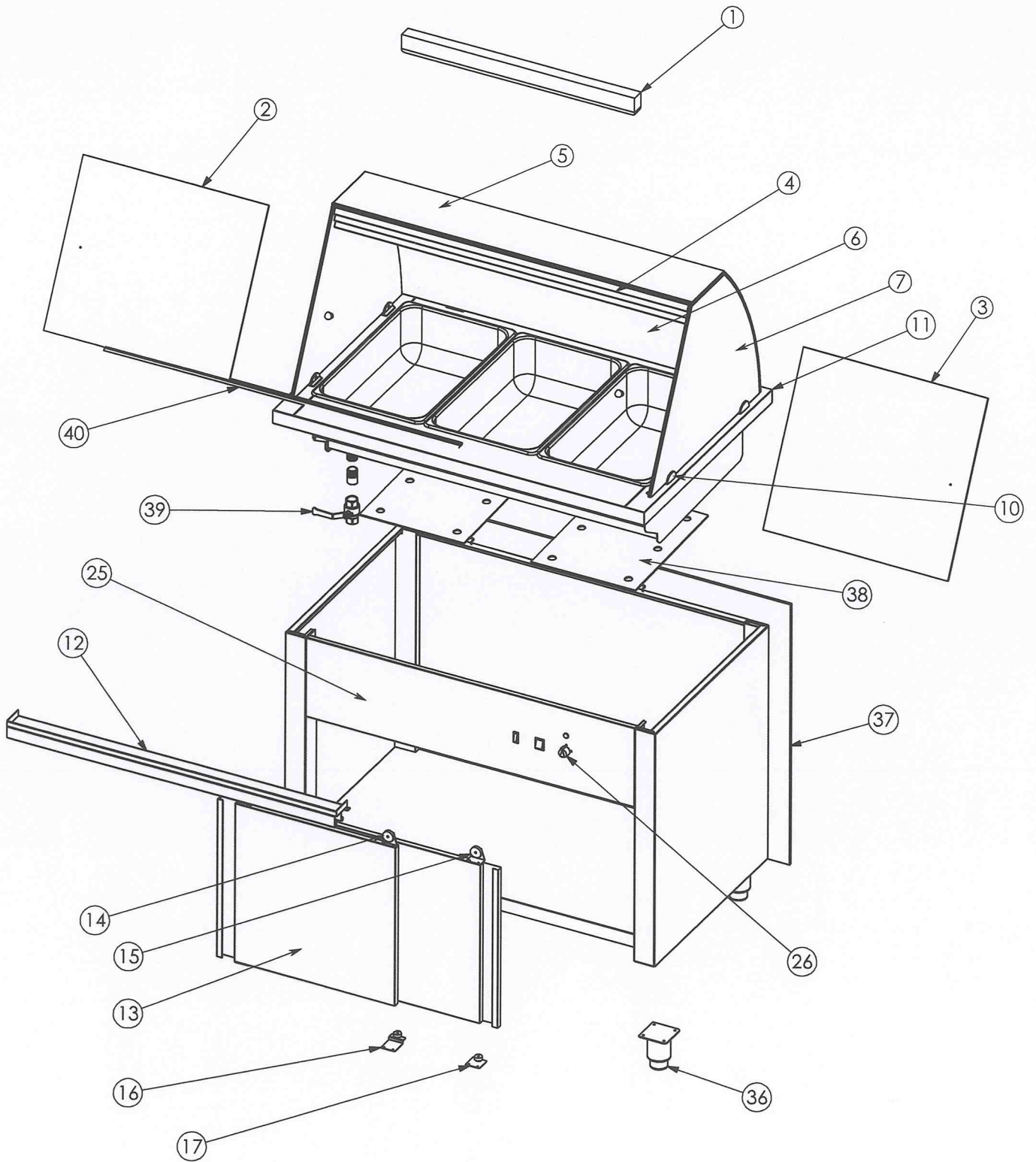

## BAIN MARIE BM-C SPARE PARTS

BM -C 107			BM - C 140		BM - C 180	
CODE	COMPONENT NAME	PCS.	COMPONENT NAME	PCS.	COMPONENT NAME	PCS.
1	LAMP	1	LAMP	1	LAMP	1
2	PLEXIGLASS LEFT COVER	1	PLEXIGLASS LEFT COVER	1	PLEXIGLASS LEFT COVER	1
3	PLEXIGLASS RIGHT COVER	1	PLEXIGLASS RIGHT COVER	1	PLEXIGLASS RIGHT COVER	1
4	LIGHTING GROUP	1	LIGHTING GROUP	1	LIGHTING GROUP	1
5	TOP GLASS	1	TOP GLASS	1	TOP GLASS	1
6	CURVED FRONT GLASS	1	CURVED FRONT GLASS	1	CURVED FRONT GLASS	1
7	SIDE GLASS	2	SIDE GLASS	2	SIDE GLASS	2
10	GLASS HOLDER	6	GLASS HOLDER	6	GLASS HOLDER	6
11	TABLE TOP (OPTIONAL GRANITE OR S/S)	1	TABLE TOP (OPTIONAL GRANITE OR S/S)	1	TABLE TOP (OPTIONAL GRANITE OR S/S)	1
12	DOOR GUIDE GROUP	1	DOOR GUIDE GROUP	1	DOOR GUIDE GROUP	1
13	SLIDING DOOR	2	SLIDING DOOR	2	SLIDING DOOR	2
14	FRONT DOOR UPPER ROLLER	2	FRONT DOOR UPPER ROLLER	2	FRONT DOOR UPPER ROLLER	2
15	BACK DOOR UPPER ROLLER	2	BACK DOOR UPPER ROLLER	2	BACK DOOR UPPER ROLLER	2
16	FRONT DOOR LOWER ROLLER	2	FRONT DOOR LOWER ROLLER	2	FRONT DOOR LOWER ROLLER	2
17	BACK DOOR LOWER ROLLER	2	BACK DOOR LOWER ROLLER	2	BACK DOOR LOWER ROLLER	2
25	CONTROL PANEL	1	CONTROL PANEL	1	CONTROL PANEL	1
26	ON-OFF BUTTON AND DIGITAL THERMOSTAT	1	ON-OFF BUTTON AND DIGITAL THERMOSTAT	1	ON-OFF BUTTON AND DIGITAL THERMOSTAT	1
36	S/S FOOT	4	S/S FOOT	4	S/S FOOT	4
37	FRONT FURNITURE PANEL	1	FRONT FURNITURE PANEL	1	FRONT FURNITURE PANEL	1
38	RESISTANCE ( 1500 W)	1	RESISTANCE ( 1250 W)	2	RESISTANCE (1500 W)	2
39	BALL VALVE	1	BALL VALVE	1	BALL VALVE	1
40	PLEXIGLASS GUIDE	1	PLEXIGLASS GUIDE	1	PLEXIGLASS GUIDE	1