



## **Tiefkühlschrank 700 I, GN 2/1, für Zentralkühlung mit Ventil R404**

Artikel-Nr.  
90622046 (7F070RBC5P002 / ARTIC 700BT R R404)

---

### **Explosionszeichnung / Ersatzteile**

---

Bitte bei Ersatzteilbestellung immer Artikelnummer und  
Seriennummer mit angeben!

# **7F070RBC5P002-CABINET 70/90 BT REM. ARTIC/FROSTY**

*Content filters: validity 11/09/2018*

*11/09/2018*

7F070RBC5P002 - 7F070RBC5P002-CABINET 70/90 BT REM. ARTIC/FROSTY.....	3
7F070RBC5P002-OPT - EXPLODED VIEW OF OPTIONAL PARTS & FEATURES.....	5
SC803 - ELECTRICAL WIRING.....	7
Components index.....	8

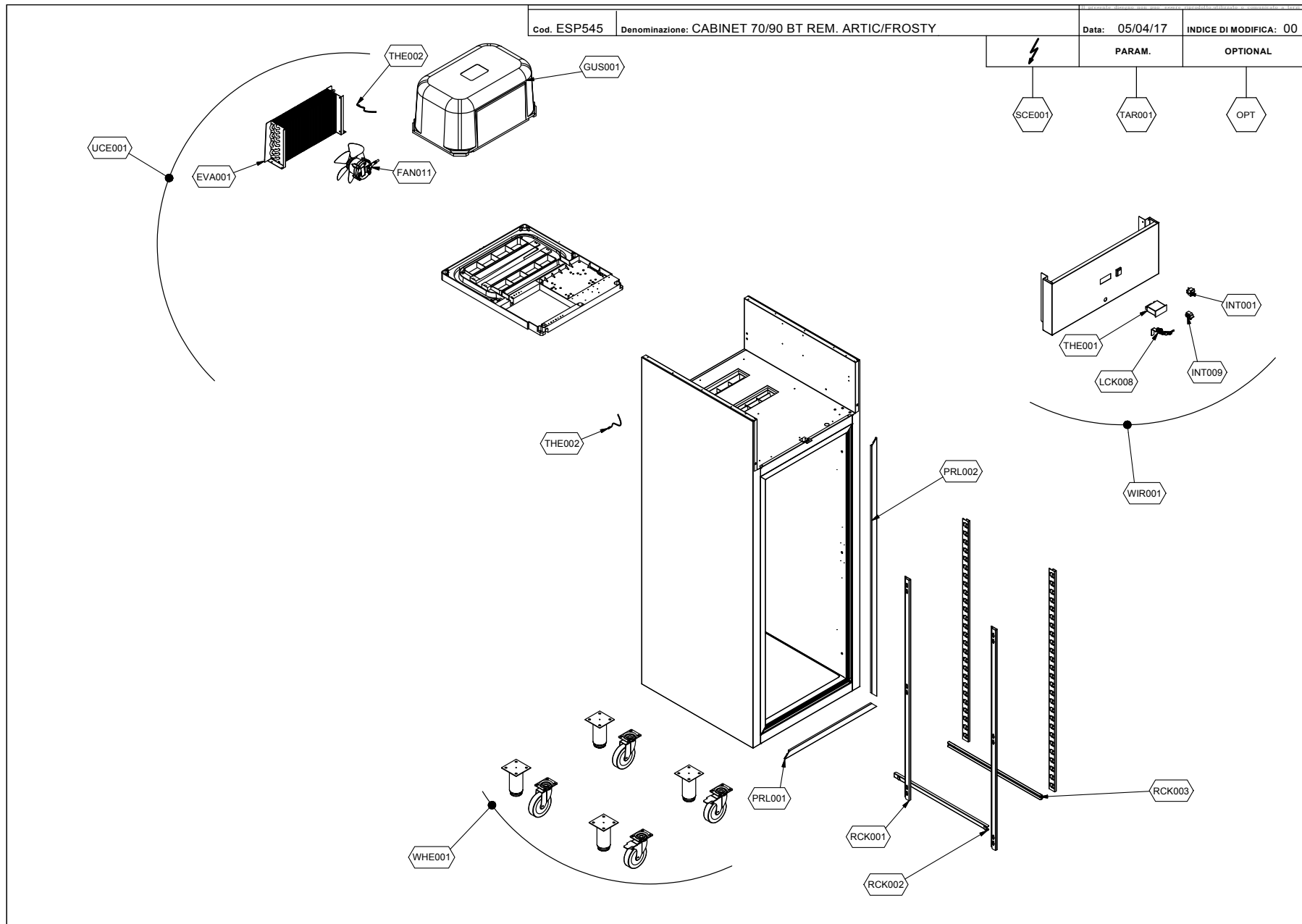





















7F070RBC5P002-CABINET 70/90 BT REM. ARTIC/FROSTY - Content filters: validity 11/09/2018

**7F070RBC5P002 - 7F070RBC5P002-CABINET 70/90 BT REM. ARTIC/FROSTY**









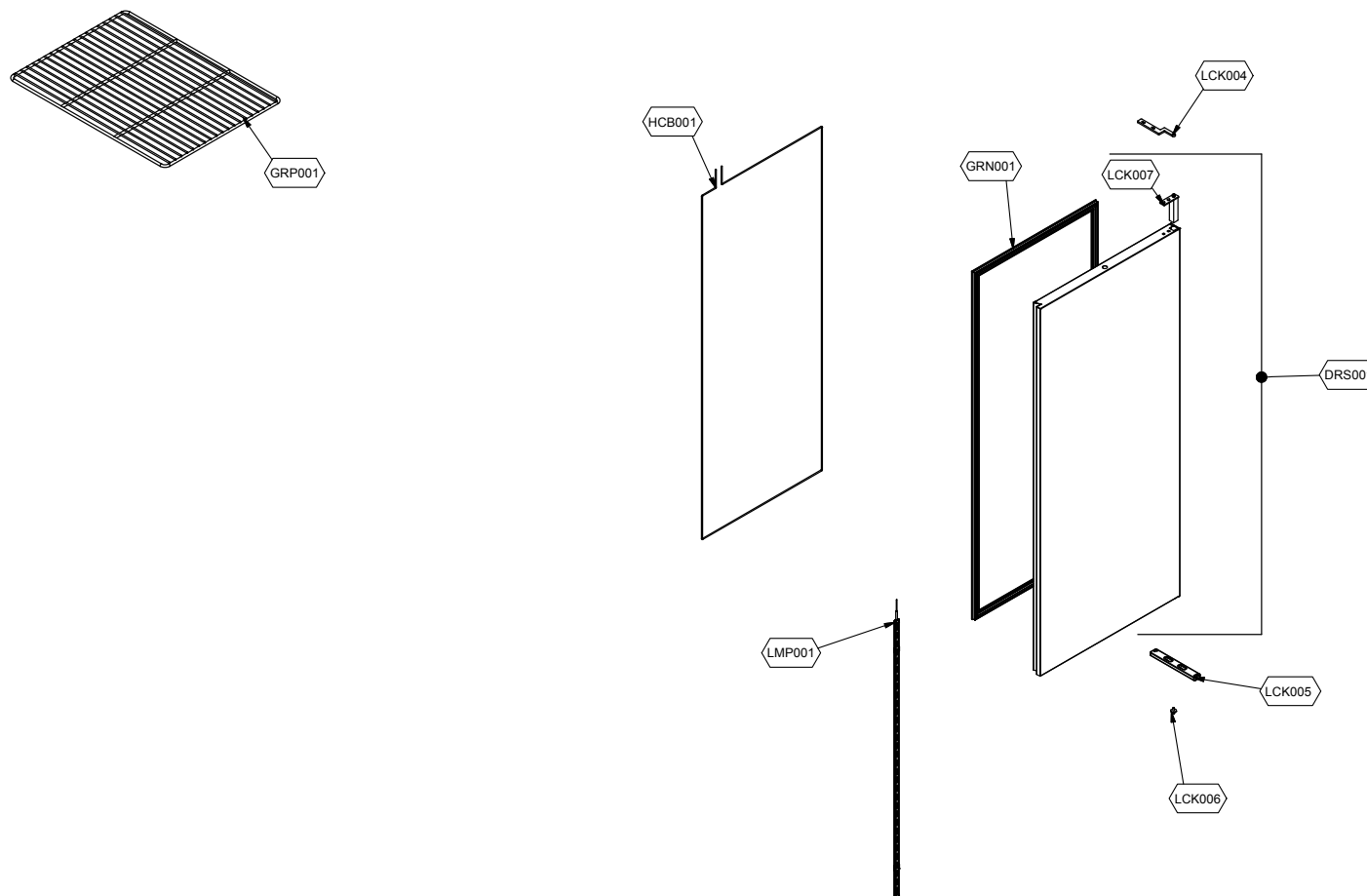

Validity: from 05/09/2018

11/09/2018

Page 3 / 8

Purch.	Pos.	Code	Q.ty	Description	Spare parts after year	Notes
	EVA001	74837324	1	EVAPORATOR	5	
	FAN011	73688646	1	KIT FAN	2	
	GUS001	74701641	1	WARM CABLE		
	HCB002	74837340	1	WARM CABLE		
	INT001	74742008	1	MAIN ON/OFF SWITCH	2	
	INT009	78010438	1	MICROSWITCH	2	
	LCK008	73692124	1	LOCK		
	OPT	7F070RBC5P002- OPT	1	EXPLODED VIEW OF OPTIONAL PARTS & FEATURES		
	PRL001	72609622	1	MOBILE HORIZONTAL COVER		
	PRL002	72609626	1	MOBILE VERTICAL COVER		
	RCK001	74779100	1	UNIVERSAL RACK		
	RCK003	74703270	1	RIGHT RUNNER		
	RST001	74837334	1	HEATING ELEMENT	2	
	RST002	74837338	1	HEATING ELEMENT	2	
	RST003	74837398	1	HEATING ELEMENT	2	
	SCE001	SC803	1	ELECTRICAL WIRING	1	
	TAR001	RIF.TAR.Q02	1	CONTROLLER PRESETTING SERVICE	1	
	THE001	74700776	1	UNSETTED ELECTRONIC CONTROLLER	1	
	THE002	74700917	1	PROBE	1	
	UCE001	74861166	1	FULL CONDENSING UNIT		
	WHE001	74702570	1	CASTOR/FEET		
	WIR001	73691820	1	ELECTRICAL PANEL		



Purch.	Pos.	Code	Q.ty	Description	Spare parts after year	Notes
	DRS001	73692252	1	DOOR		
	FAN009	73688646	1	KIT FAN	2	
	GRN001	74703386	1	GASKET	2	
	HCB001	73632294	1	WARM CABLE		
	HCB001	74837340	1	WARM CABLE		
	LCK005	74708202	1	LOWER DOOR SUPPORT		
	LCK006	74708126	1	BOTTOM HINGE		
	LMP001	74755590	1	LED LIGHTING		
	THE003	74701161	1	LED POWER PACK	1	
	WHE001	74702570	1	CASTOR/FEET		

ITALIANO	ENGLISH
SC803	EXHAUSTIVE FAN
RESISTENZA DI SCAMBIO	EXHAUST RESISTOR
COMPRESSORE	COMPRESSOR
VENTILATORE CONDENSATORE	CONDENSER FAN
CONDENSATORE	CONDENSER TANK
RESISTENZA SCAMBIO CALORE	HEAT EXCH. RESISTOR
PLACCA DI TERZO PANNELLO COMANDI	CONTROL PANEL (3RD)
CONDENSATORE	CONDENSER
SONDA SENZA CELLA	ROOM THERMISTOR
SONDA EVAPORANTE	EVAPORATOR PROBE
CONDENSATORE	CONDENSER
INTERRUTTORE ON/OFF	ON/OFF SWITCH
LAMPADA VITRINA A LED	LED LIGHT
RESISTENZA IN SOLUZIONE	SOLUTION RESISTOR
RESISTENZA ALLUMINIO ACCIAIO TAVOLA	ALUMINIUM RESISTOR
RESISTENZA	RESISTOR
RESISTENZA TAVOLA COMANDO	CONTROL TABLE RESISTOR

ATTENZIONE:  
Tutti i codi singoli devono essere contenuti  
in uno spazio dove per alfanumerico riferito.  
----- CARICAZIONE (NON IN FANING)  
----- CARICAZIONE (NON IN FANING)

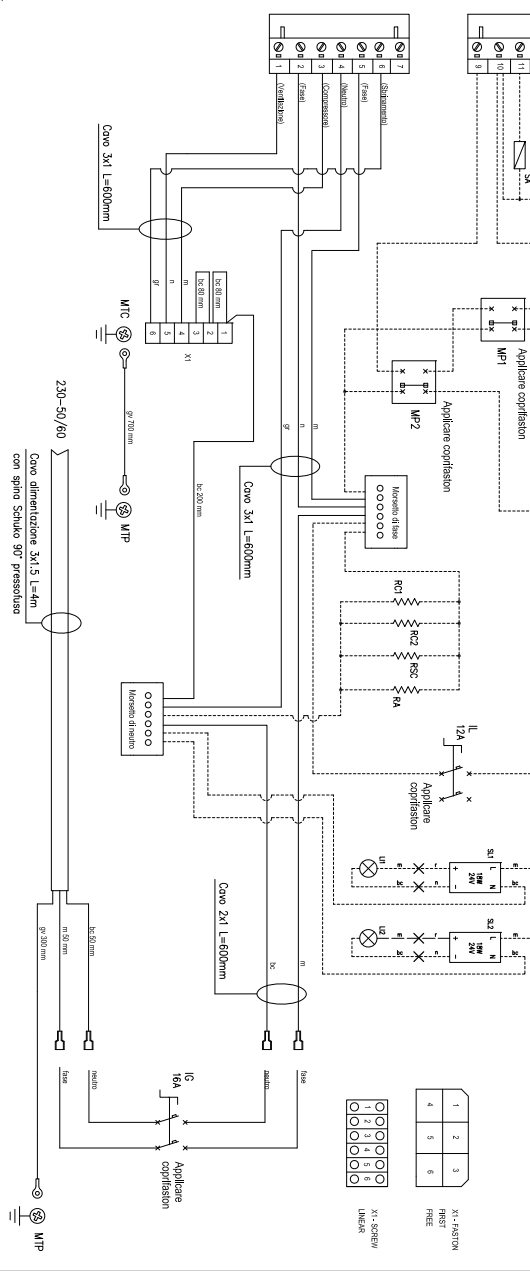
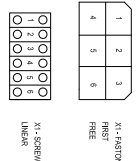
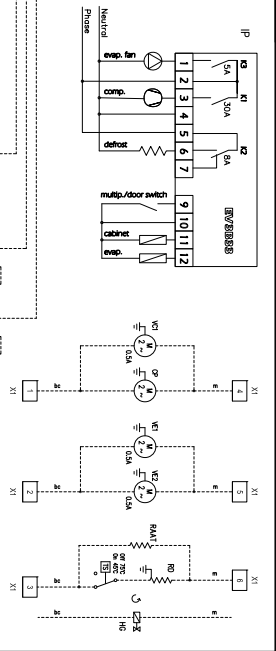

DESCRIZIONE MATERIALE	QTY	REVISIONI	REVISIONI	REVISIONI	REVISIONI	REVISIONI
06 01-12-16	---	Modificato collegamento lampada led	K. Chiero	K. Chiero	K. Chiero	
05 12-07-16	---	Aggiunto collegamento resistenza evapor condensera RA	K. Chiero	K. Chiero	K. Chiero	
REV. DATA	MANUALI	MODIFICHE		DESCRIZIONE CONTROLLO		

A. TERMINI DI USCITA E RIMBORSI. LA RIMBORSO E' DI QUESTO TIPO: CON CONTRO DA RIPRODURRE E DA RISPONDERE QUANTO A TUTTI I TIPI DI MODIFICHE, TRAMITE SEGNALAZIONE E CON CONTRO DA RIPRODURRE E DA RISPONDERE QUANTO A TUTTI I TIPI DI MODIFICHE, TRAMITE SEGNALAZIONE



Code	Parts Table	Pos.	Q.ty
72609622	7F070RBC5P002	PRL001	1
72609626	7F070RBC5P002	PRL002	1
73632294	7F070RBC5P002- OPT	HCB001	1
73688646	7F070RBC5P002	FAN011	1
	7F070RBC5P002- OPT	FAN009	1
73691820	7F070RBC5P002	WIR001	1
73692124	7F070RBC5P002	LCK008	1
73692252	7F070RBC5P002- OPT	DRS001	1
74700776	7F070RBC5P002	THE001	1
74700917	7F070RBC5P002	THE002	1
74701161	7F070RBC5P002- OPT	THE003	1
74701641	7F070RBC5P002	GUS001	1
74702570	7F070RBC5P002	WHE001	1
	7F070RBC5P002- OPT	WHE001	1
74703270	7F070RBC5P002	RCK003	1
74703386	7F070RBC5P002- OPT	GRN001	1
74708126	7F070RBC5P002- OPT	LCK006	1
74708202	7F070RBC5P002- OPT	LCK005	1
74742008	7F070RBC5P002	INT001	1
74755590	7F070RBC5P002- OPT	LMP001	1
74779100	7F070RBC5P002	RCK001	1
74837324	7F070RBC5P002	EVA001	1
74837334	7F070RBC5P002	RST001	1
74837338	7F070RBC5P002	RST002	1
74837340	7F070RBC5P002	HCB002	1

Code	Parts Table	Pos.	Q.ty
	7F070RBC5P002- OPT	HCB001	1
74837398	7F070RBC5P002	RST003	1
74861166	7F070RBC5P002	UCE001	1
78010438	7F070RBC5P002	INT009	1
RIF.TAR.Q02	7F070RBC5P002	TAR001	1