

# KROMO

TABLE

KI4310

REV

05

## GLASSWASHER K 45

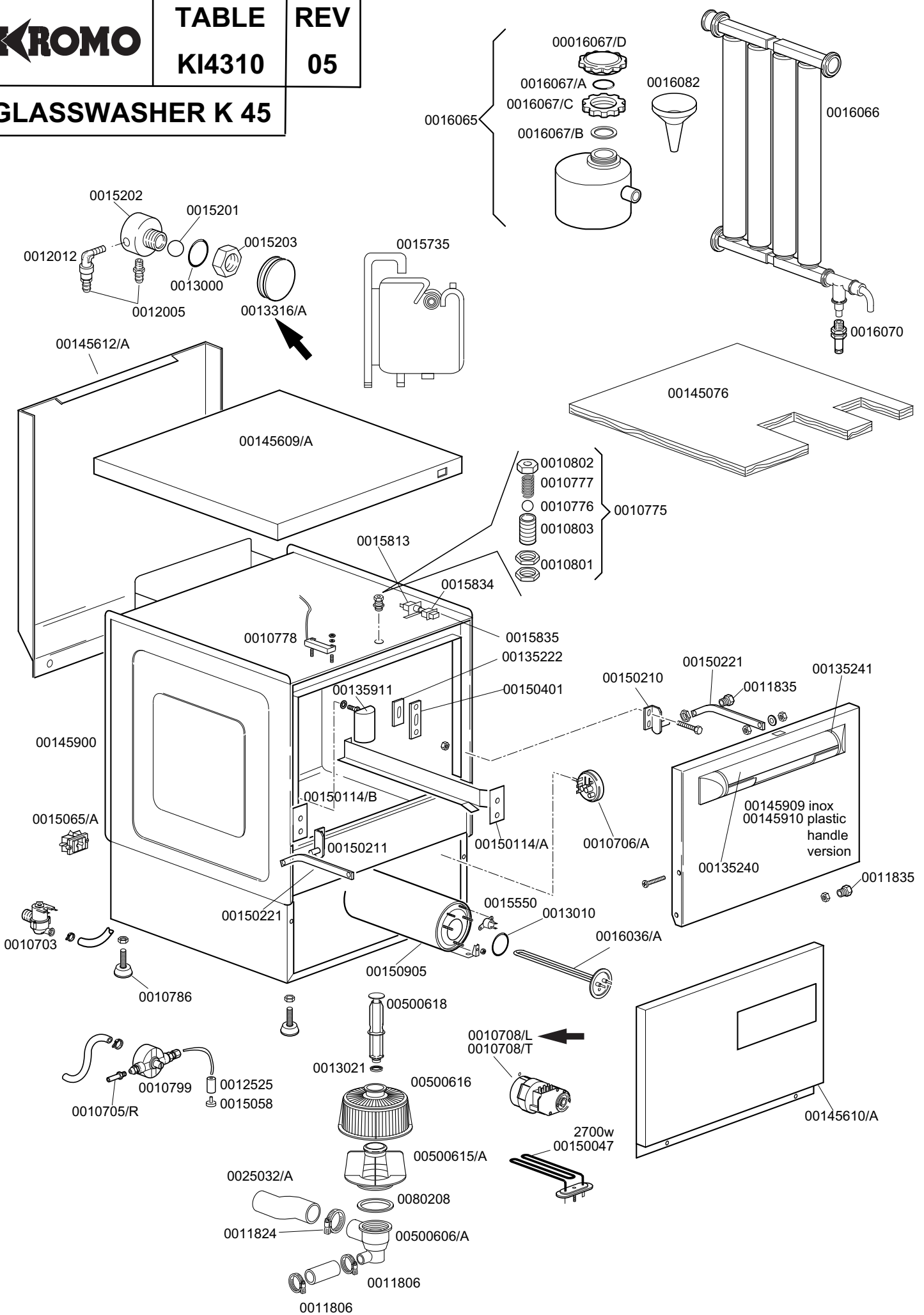

**GLASSWASHER K 45**

**TABLE  
KI4310**

<b>CODE</b>	<b>DESCRIPTION</b>	<b>CODE</b>	<b>DESCRIPTION</b>
0010703	220V entry solenoid valve	0016067/D	Salt container plug
0010705/R	D.8 pipe fitting	0010708/L	Rapid timer 120"230/50 Hz ←
0010706/A	"EL" pressure switch	0013316/A	Blind gasket for DVGW hole ←
0010708/T	Timer 150" 230V 50Hz thermostop	0016070	CFD complete non-return valve
0010775	Brass door hook	0016082	Funnel
0010776	9.52 diam. stainless steel ball	0025032/A	Coupling for suction K50
0010777	Spring for door hook	00500606	Right floor drain grey
0010778	Reed magnetic microswitch	00500615/A	Ferrule with filter - grey
0010786	40 d. M10x25 small black foot	00500616	Filter for suction
0010799	Shining product dosing device	00500618	Overflow device
0010801	Door jack nut	0080208	Ramp seal 95x75x3
0010802	Door jack locknut		
0010803	Door jack body		
0011806	25/40 stainless steel clamps		
0011824	50/70 clamps		
0011835	Brass bush		
0012005	1/4 rubber holder for 10 d. pipe		
0012012	Elbow pipe fitting 1/4 brass		
0012525	Counter-weight for small filter		
0013000	OR 3125 gasket		
0013010	OR heating element gasket		
0013021	DEM 40 gasket		
00135222	Beating door		
00135240	Handle door in plastic		
00135241	Ending of handle K		
00135911	Complete air trap		
00145076	Polystyrene coat K 45		
00145609/A	Lid for K 45		
00145610/A	Lower door K 45		
00145612/A	Dorsal panel K 45		
00145900	Complete body K 45		
00145909	Complete door K 45 handle plastic version		
00145910	Complete door K 45 inox version		
00150047	Tube el. resistance 2,7kw 230v		
00150114/A	Right guide for basket		
00150114/B	Left guide for basket		
00150210	Right hinge door		
00150211	Left hinge door		
00150221	Door rod		
00150401	Guide for bent rod		
0015058	Small shining product suction filter		
0015065/A	Cable fastener with screw		
00150905	Boiler mod. 50		
0015201	17d. teflon DVGW safety valve sphere		
0015202	40x33 d. DVGW brass pipe fitting		
0015203	30 DVGW brass nut for pipe fitting		
0015550	Conveyer safety thermostat		
0015735	2,7 lt. break tank		
0015813	16A unipolar switch electric component		
0015834	Start switch		
0015835	Square start push button		
0016036/A	230V 2,5 kw heating element		
0016065	Salt container		
0016067/A	OR for salt container plug		
0016067/B	Salt container gasket		
0016067/C	Salt container ferrule		

**KROMO**

**TABLE  
KI4330**

**REV  
02**

**DISHWASHER K 45**

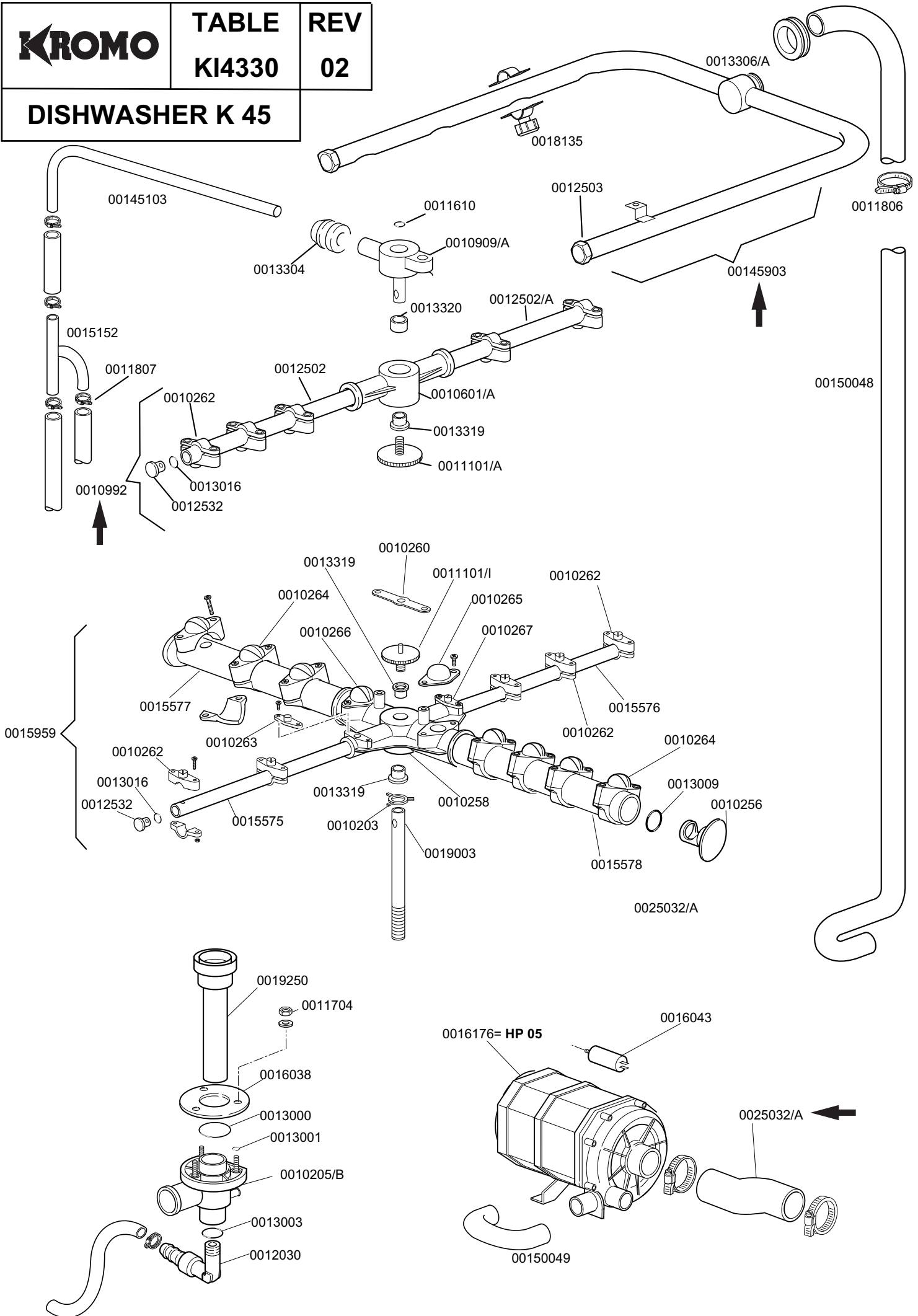

**DISHWASHER K 45**

**TABLE  
KI4330**

CODE	DESCRIPTION	CODE	DESCRIPTION
0010203	Pipe guide		
0010205/B	Lower wash turret		
0010221	Grey nozzle		
0010256	D.18 grey cap		
0010258	4 ways small grey endorser		
0010260	Plate for rotor		
0010262	D.10 rinse grey nozzle		
0010263	D.10 grey open level nozzle		
0010263	D.10 grey closed level nozzle		
0010265	D.28 grey closed level nozzle		
0010266	D.18 grey open level nozzle		
0010267	Closed wash jet D.10 (grey)		
0010601/A	Upper rinse rotor 2 ways		
0010909/A	Turret upper grey rinse		
0010992	Top rinse group		
0011101/A	30x11 d. M8 group fasten screw		
0011101/I	Knurled stainless steel group screw		
0011610	Copper wash		
0011704	M5 stainless steel nut		
0011806	25/40 stainless steel clamps		
0011807	12/20 stainless steel clamps		
0012030	Elbow connection K37/K40		
0012502	Top left rinse pipe		
0012502/A	Top right rinse pipe		
0012503	20 mm wash pipe closing plug		
0012532	Grey cap D.10		
0013000	OR 3125 EP		
0013001	OR 104 EP		
0013003	OR 112 EP for rinse pipe fitting		
0013009	OR 2050 gasket for 18 d. pipe		
0013016	OR 103 (OR 2018) gasket		
0013304	Pipe-pass gasket		
0013306/A	Pump gasket		
0013319	PTFE+CB H 11.5 sliding washer		
0013320	14x10.2x6 D. PTFE+CD sliding washer		
00145103	45 rinse ramp		
00145903	Top wash pipe 45		
00150048	Upper coupling washing 50		
00150049	Lower coupling washing 50		
0025032/A	50 d. suction pipe		
0015152	10x1 3 way turnout		
0015575	G94 right rinse pipe		
0015576	G94 left rinse pipe		
0015577	18 d. G94 right wash pipe		
0015578	18 d. G94 left wash pipe		
0015959	Wash rinse group 45		
0016038	60d. stainless steel disk		
0016043	0.40 Hppump condensor		
0016176	0.5 hp motor pump		
0018135	Wash nozzle		
0019003	10x1x190 stainless steel axis		
0019250	Glass unit with coupling		

<b>KROMO</b>	<b>TABLE</b>	<b>REV</b>
	<b>KI4461</b>	<b>00</b>
<b>DISHWASHER K 45-50-80</b>		

REGENERATION / DRAIN PUMP VERSION

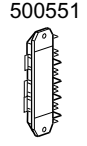
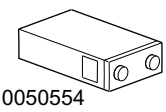
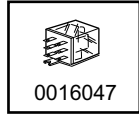

0010708/B  
0010708/T  
0010708/L

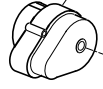

0016037= 230V  
0015620=220/240V



0050557

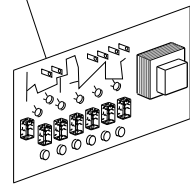

0050559

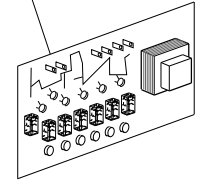

0050562

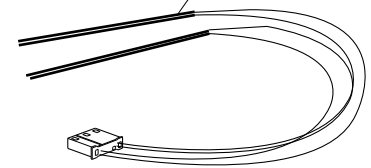

0010707/1

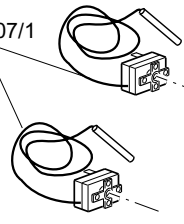

00150309/A

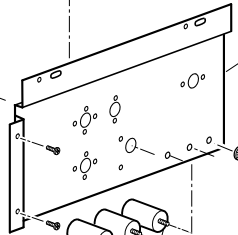

0015149

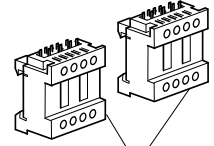

0015086= 230V 50/60Hz  
0015086/B= 240V 50Hz

00150111-K50  
00150121-K80

00135606/A(Gray)  
00135603/A  
00135616

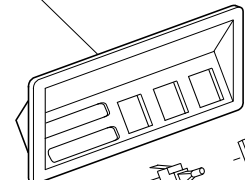

0015812 0015824 0015874

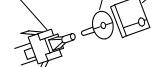

0015825

0015826

0015870  
0015854



0015811/A  
0015813

0015880

0010500011

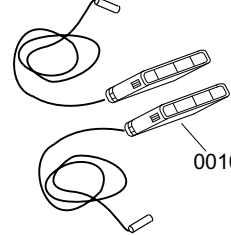

STANDARD CONTROL PANEL K-45/50/80

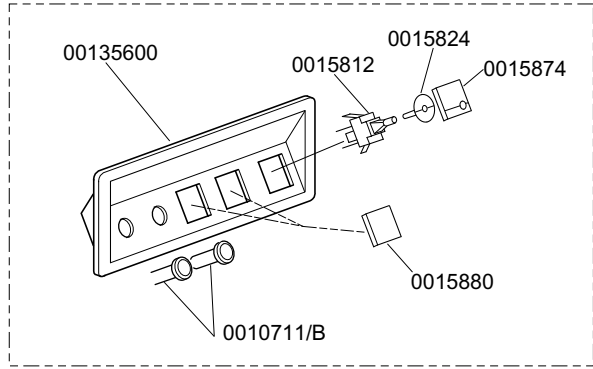

0015812 0015824 0015874

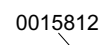

0015880

0015854 0015858

0015813

0015813

