



Kühlschrank 1400 I, GN 2/1, für Zentralkühlung mit Ventil R134

Artikel-Nr.

90621061 (7E140RNC5P003 / ENERGY 1400TN R R134)

Explosionszeichnung / Ersatzteile

Bitte bei Ersatzteilbestellung immer Artikelnummer und
Seriennummer mit angeben!

7E140RNC5P003-CABINET 1400 TN REM. ENERGY

Content filters: validity 11/09/2018

11/09/2018

7E140RNC5P003 - 7E140RNC5P003-CABINET 1400 TN REM. ENERGY..... 3
 7E140RNC5P003-OPT - EXPLODED VIEW OF OPTIONAL PARTS & FEATURES..... 5
 SC720 - ELECTRICAL WIRING..... 7
Components index..... 8

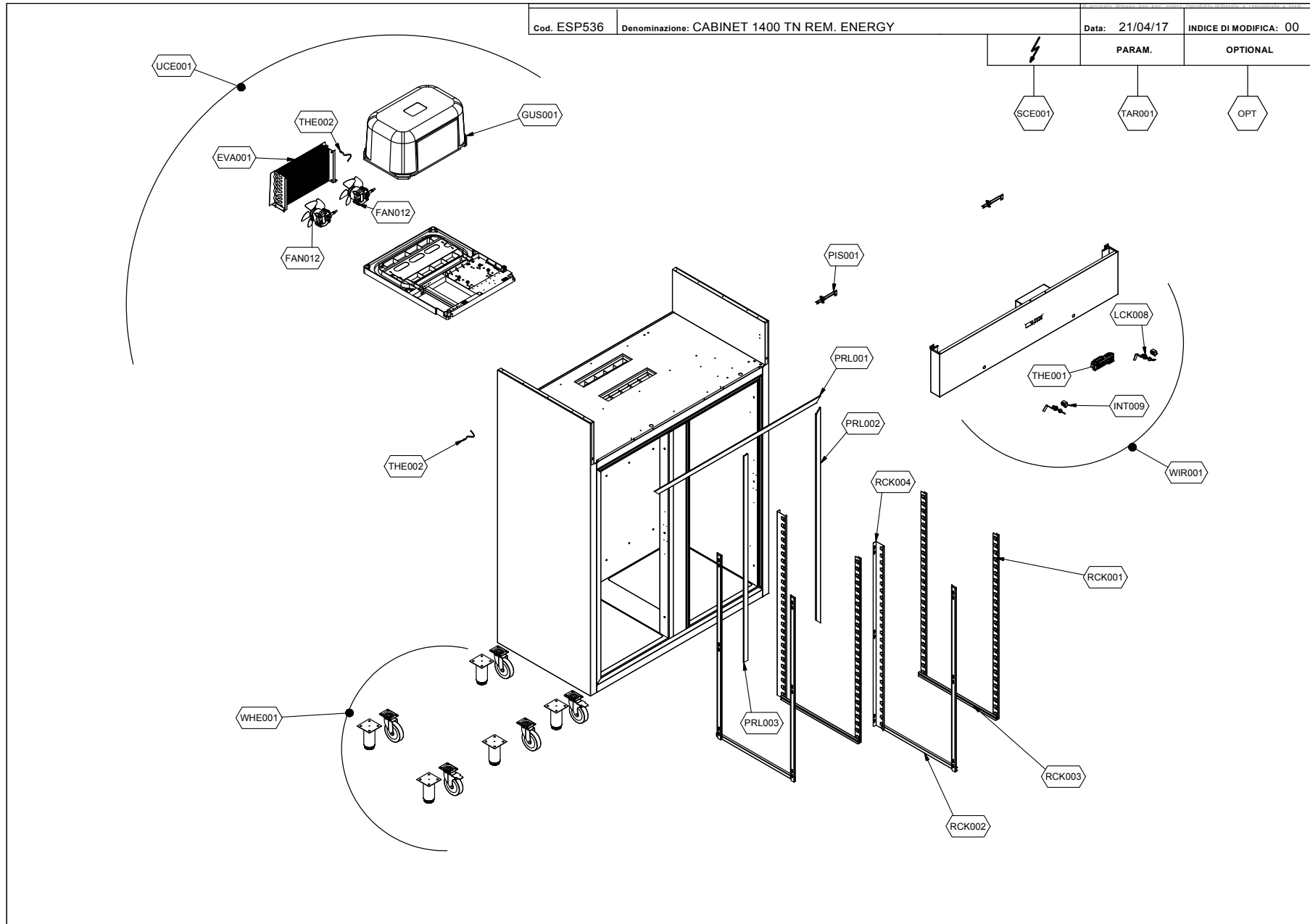





















7E140RNC5P003-CABINET 1400 TN REM. ENERGY - Content filters: validity 11/09/2018

7E140RNC5P003 - 7E140RNC5P003-CABINET 1400 TN REM. ENERGY





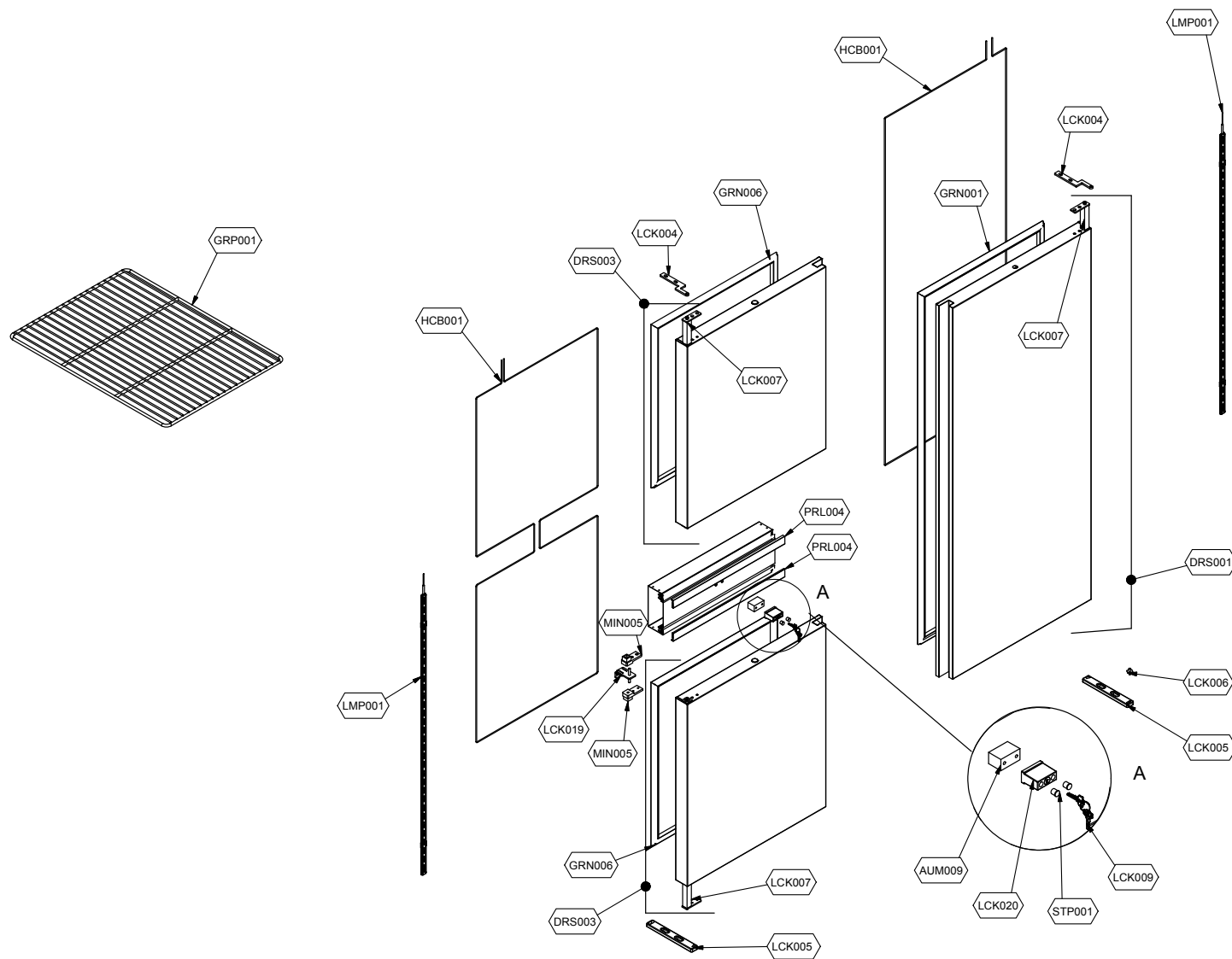

Validity: from 23/01/2018

11/09/2018

Page 3 / 8

Purch.	Pos.	Code	Q.ty	Description	Spare parts after year	Notes
	EVA001	74837324	1	EVAPORATOR	5	
	FAN012	73688648	1	KIT FAN	2	
	GUS001	74701641	1	WARM CABLE		
	INT009	78010438	1	MICROSWITCH	2	
	LCK008	73688080	1	LOCK		
	OPT	7E140RNC5P003- OPT	1	EXPLODED VIEW OF OPTIONAL PARTS & FEATURES		
	PIS001	74700180	1	PISTON	3	
	PRL001	72609642	1	MOBILE HORIZONTAL COVER		
	PRL002	72609626	1	MOBILE VERTICAL COVER		
	PRL003	72609662	1	MOBILE VERTICAL COVER		
	RCK001	74779100	1	UNIVERSAL RACK		
	RCK003	74703270	1	RIGHT RUNNER		
	RCK004	74779108	1	BACK RACK		
	RST001	74837334	1	HEATING ELEMENT	2	
	RST002	74837338	1	HEATING ELEMENT	2	
	RST003	74837398	1	HEATING ELEMENT	2	
	SCE001	SC720	1	ELECTRICAL WIRING	1	
	TAR001	RIF.TAR.P03	1	CONTROLLER PRESETTING SERVICE	1	
	THE001	74700889	1	UNSETTED ELECTRONIC CONTROLLER	1	
	THE002	74700917	1	PROBE	1	
	UCE001	74861164	1	FULL CONDENSING UNIT		
	WHE001	74702570	1	CASTOR/FEET		
	WIR001	73691882	1	ELECTRICAL PANEL		



Purch.	Pos.	Code	Q.ty	Description	Spare parts after year	Notes
	DRS001	73692250	1	DOOR		
	FAN009	73688648	1	KIT FAN	2	
	GRN001	74703384	1	GASKET	2	
	LCK005	74708202	1	LOWER DOOR SUPPORT		
	LMP001	74755590	1	LED LIGHTING		
	THE003	74701161	1	LED POWER PACK	1	
	WHE001	74702570	1	CASTOR/FEET		

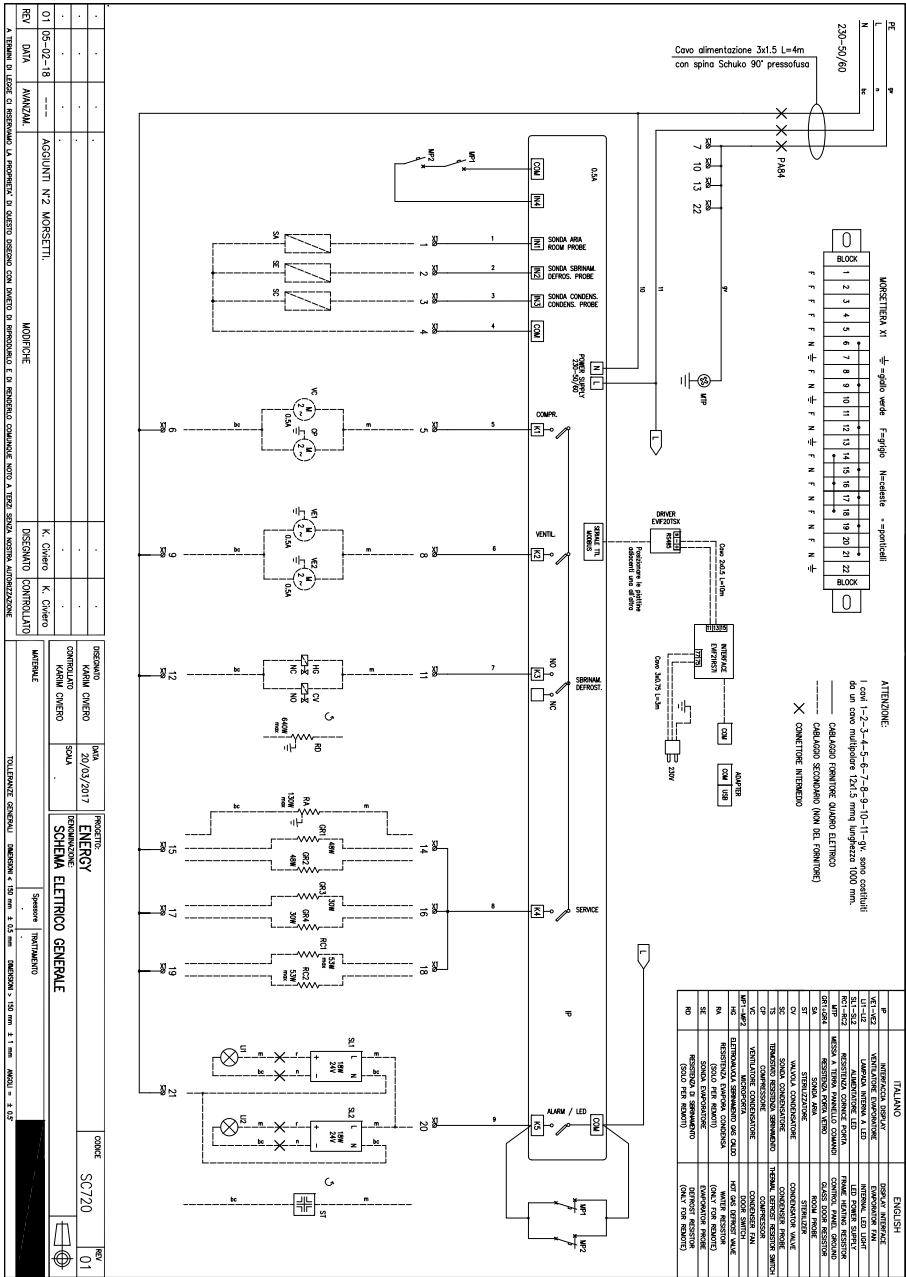

REV.	DATA	MANUALE	MODIFICHE	DISCANTO	CONTROLLO
01	05-02-18	---	AGGIUNTI VZ MORSETTI.	K. Chiaro	K. Chiaro

PROGETTO	DATA	PRODOTTORE	PRODOTTORE
SCHEMA ELETTRICO GENERALE	20/03/2017	ENERGY	ENERGY

DISCANTO	DATA	PRODOTTORE	PRODOTTORE
CONTROLLI GENERALI	SC720	ENERGY	ENERGY

REVISIONI	DATA	PRODOTTORE	PRODOTTORE
01	05-02-18	---	AGGIUNTI VZ MORSETTI.

7E140RC5P003-CABINET 1400 TN REM. ENERGY - Content filters: validity 11/09/2018
SC720 - ELECTRICAL WIRING
 Validity: from 23/01/2018

Code	Parts Table	Pos.	Q.ty
72609626	7E140RNC5P003	PRL002	1
72609642	7E140RNC5P003	PRL001	1
72609662	7E140RNC5P003	PRL003	1
73688080	7E140RNC5P003	LCK008	1
73688648	7E140RNC5P003	FAN012	1
	7E140RNC5P003- OPT	FAN009	1
73691882	7E140RNC5P003	WIR001	1
73692250	7E140RNC5P003- OPT	DRS001	1
74700180	7E140RNC5P003	PIS001	1
74700889	7E140RNC5P003	THE001	1
74700917	7E140RNC5P003	THE002	1
74701161	7E140RNC5P003- OPT	THE003	1
74701641	7E140RNC5P003	GUS001	1
74702570	7E140RNC5P003	WHE001	1
	7E140RNC5P003- OPT	WHE001	1
74703270	7E140RNC5P003	RCK003	1
74703384	7E140RNC5P003- OPT	GRN001	1
74708202	7E140RNC5P003- OPT	LCK005	1
74755590	7E140RNC5P003- OPT	LMP001	1
74779100	7E140RNC5P003	RCK001	1
74779108	7E140RNC5P003	RCK004	1
74837324	7E140RNC5P003	EVA001	1
74837334	7E140RNC5P003	RST001	1
74837338	7E140RNC5P003	RST002	1
74837398	7E140RNC5P003	RST003	1
74861164	7E140RNC5P003	UCE001	1
78010438	7E140RNC5P003	INT009	1

Code	Parts Table	Pos.	Q.ty
RIF.TAR.P03	7E140RNC5P003	TAR001	1