

PC-61GF PC-62GF

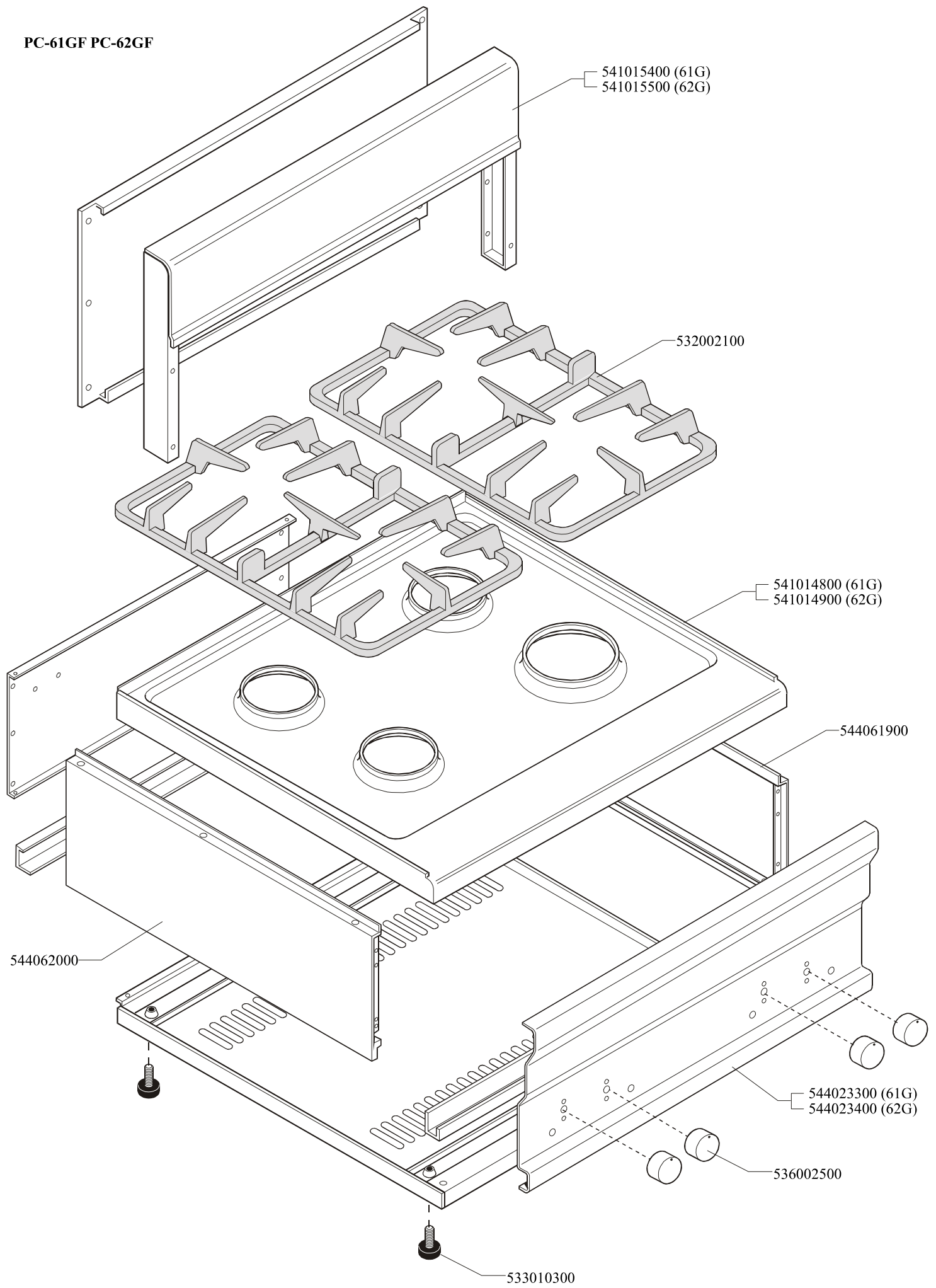

PC-61GF PC-62GF

	*	**
G30- 28+30mbar G31- 37mbar	533032100	533032200
G30- 50mbar	533049000	533032100
G20- 20mbar G25- 25mbar	533049100	533032300
G25- 20mbar	533032400	533012500
G25- 25mbar NL	533049200	533032500

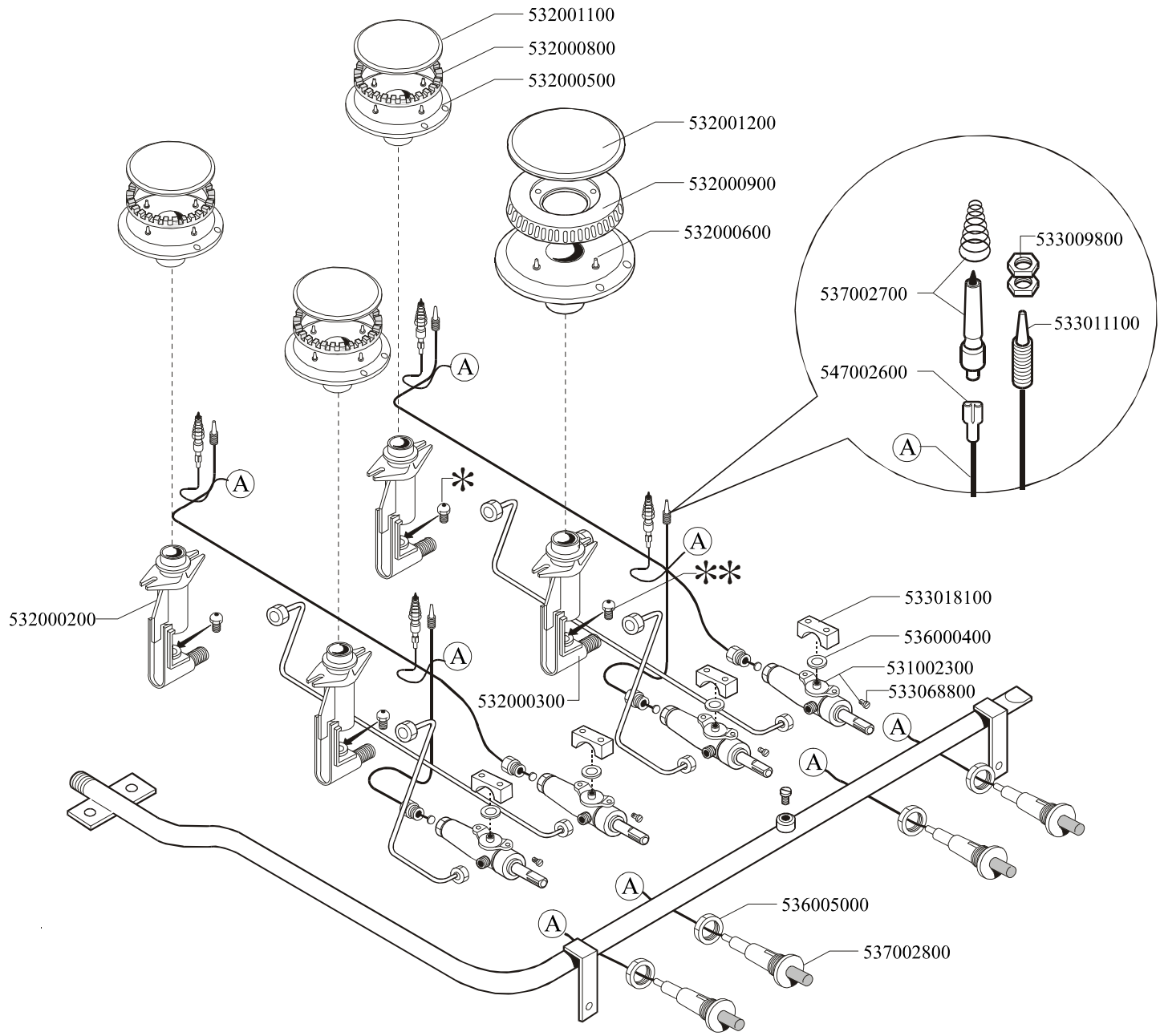

Page	Pos	Code	Description
001		541015400	NEUTRAL SPACER 61
001		532002100	2 BURNERS GRID
001		541014800	UPPER PLATE PC-61G
001		544061900	RIGHT SIDE PANEL 60 LINE
001		544023300	CONTROL PANEL PC-1G
001		536002500	COCK KNOB
001		533010300	ADJUSTABLE FOOT M10*20 D.23
001		544062000	LEFT SIDE PANEL 60 LINE
002		533032100	NOZZLE §82 CH9*10 CE G-R
002		533032200	NOZZLE §96 CH9*10 CE G-UR
002		533049000	NOZZLE §72 CH9*10 F-R
002		533049100	NOZZLE §125 CH9*10 H-R
002		533032300	NOZZLE §142 G20
002		533032400	NOZZLE §135 CH9*10 L-R
002		533012500	NOZZLE §160 CH9*10 L-UR
002		533049200	NOZZLE §130 CH9*10 AARD.L-R
002		533032500	NOZZLE §150 CH9*10 AARD.L-UR
002		532001100	QUICK BURNER COVER IN CAST IRON
002		532000800	QUICK BURNER RING
002		532000500	QUICK BURNER SUPPORT 2HOLES
002		532001200	ULTRA-QUICK BURNER COVER IN CAST IR
002		532000900	ULTRA-QUICK BURNER RING
002		532000600	ULTRA-QUICK BURNER SUPPORT 2HOLES
002		537002700	PLUG WITH SPRING H57
002		547002600	HIGH-VOLTAGE CABLE L=500
002		533009800	BRASS NUT M8*1
002		533011100	THERMOCOUPLE 600 M8*1
002		533018100	BRIDLE D.21
002		536000400	GASKET FOR COCK
002		531002300	TAP WITH VALVE BY PASS 485/042 CE
002		533068800	BY PASS COCK §42 PC/CF-60
002		536005000	NUT M18 FOR PIEZOELECTRIC IGNITION
002		537002800	PIEZOELECTRIC IGNITION M18
002		532000300	ULTRA-QUICK BURNER VENTURI
002		532000200	QUICK BURNER VENTURI