

**Kühlung
Schockfroster**

Artikel-Nr. 671005 (BF081AF)

Explosionszeichnung / Ersatzteile

Bitte bei Ersatzteilbestellung immer Seriennummer mit angeben!

031 · 051 · 081 · 121 · 161

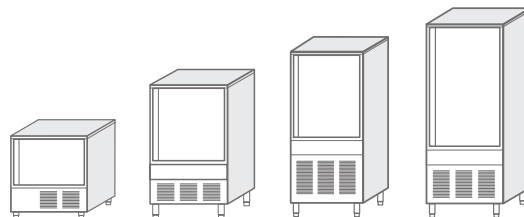

IT

ABBATTITORI RAPIDI
per gastronomia, pasticceria, gelateria

GB

BLAST CHILLER FREEZERS
for gastronomy, pastry, ice-cream

DE

SCHNELLABKÜHLER SCHOCKFR.
für Gastronomy, Gebäck, Speiseeis

FR

CELLULES REFROIDISSEMENT
pour gastronomie, pâtisserie, glacerie

ES

ABATIDORES
para gastronomia, pasteleria, heladeria

PT

EXPLUDA FREEZER
para o gastronomia, pastelaria, geleira

GR

ΤΣΙΛΙ ΦΥΣΗΜΑΤΟΣ
για τη γαστρονομία, ζύμη, παγωτό

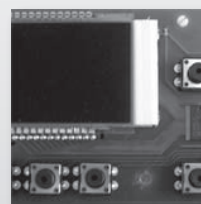

ESC03071Z

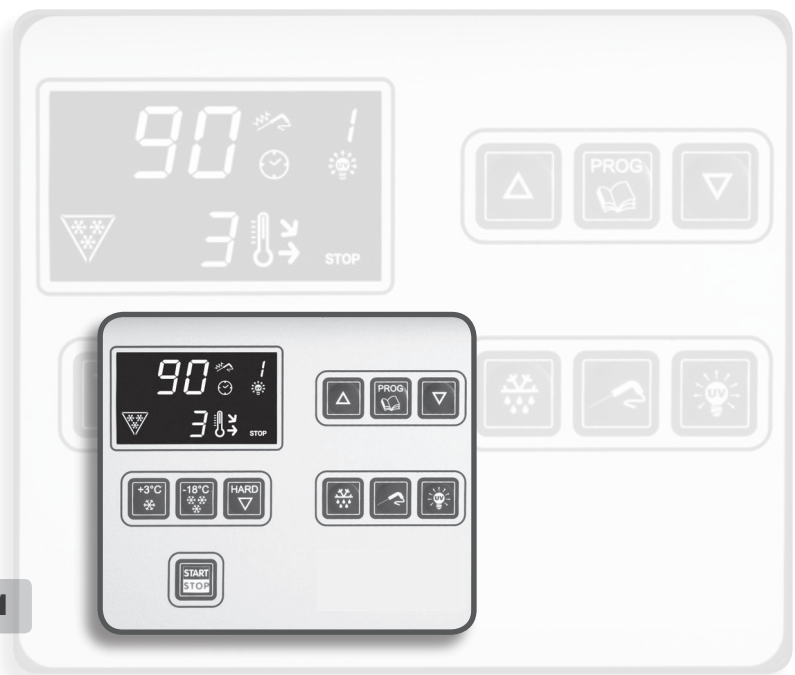
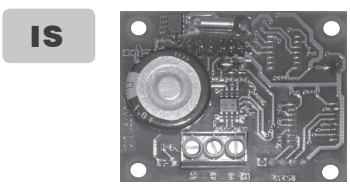
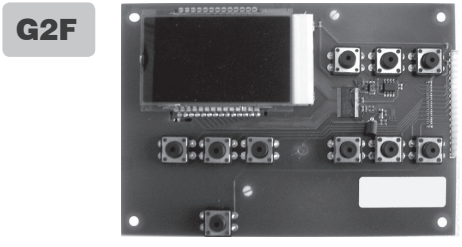

MAS1

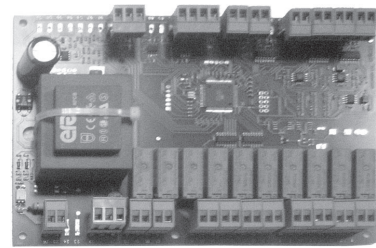

G1P

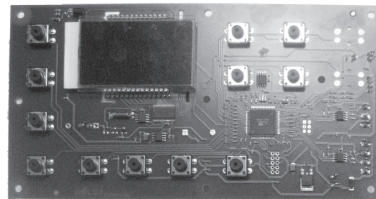

G2P



G6P



CRS F/P+ST

CRS F/P

CRI

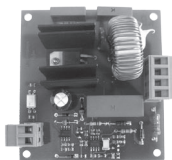

G5



CK

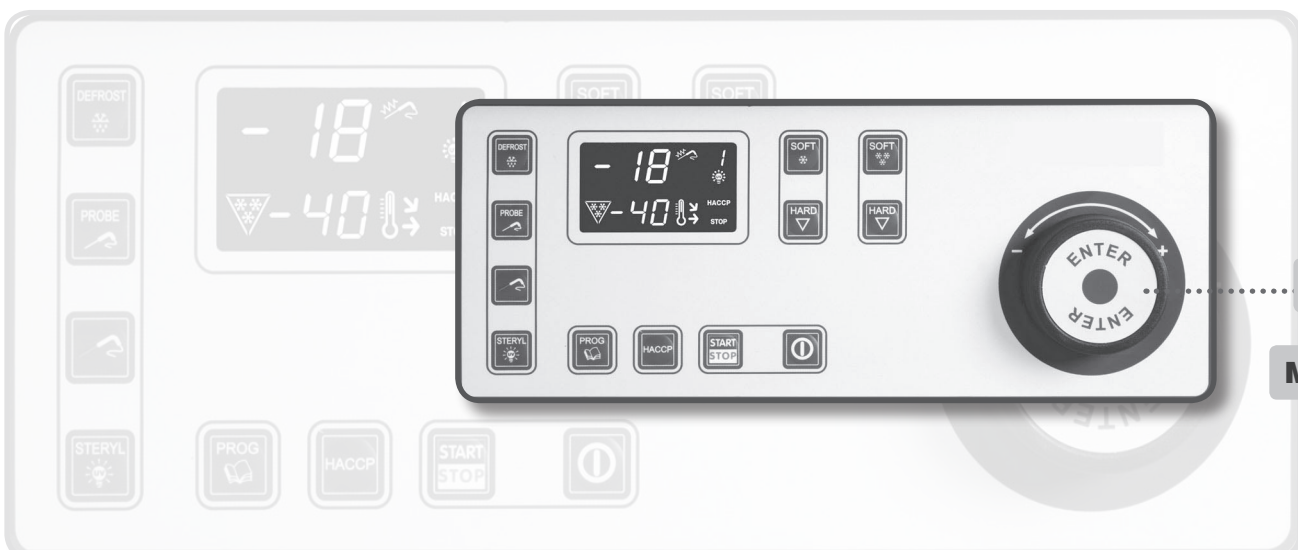

ME

MAS2

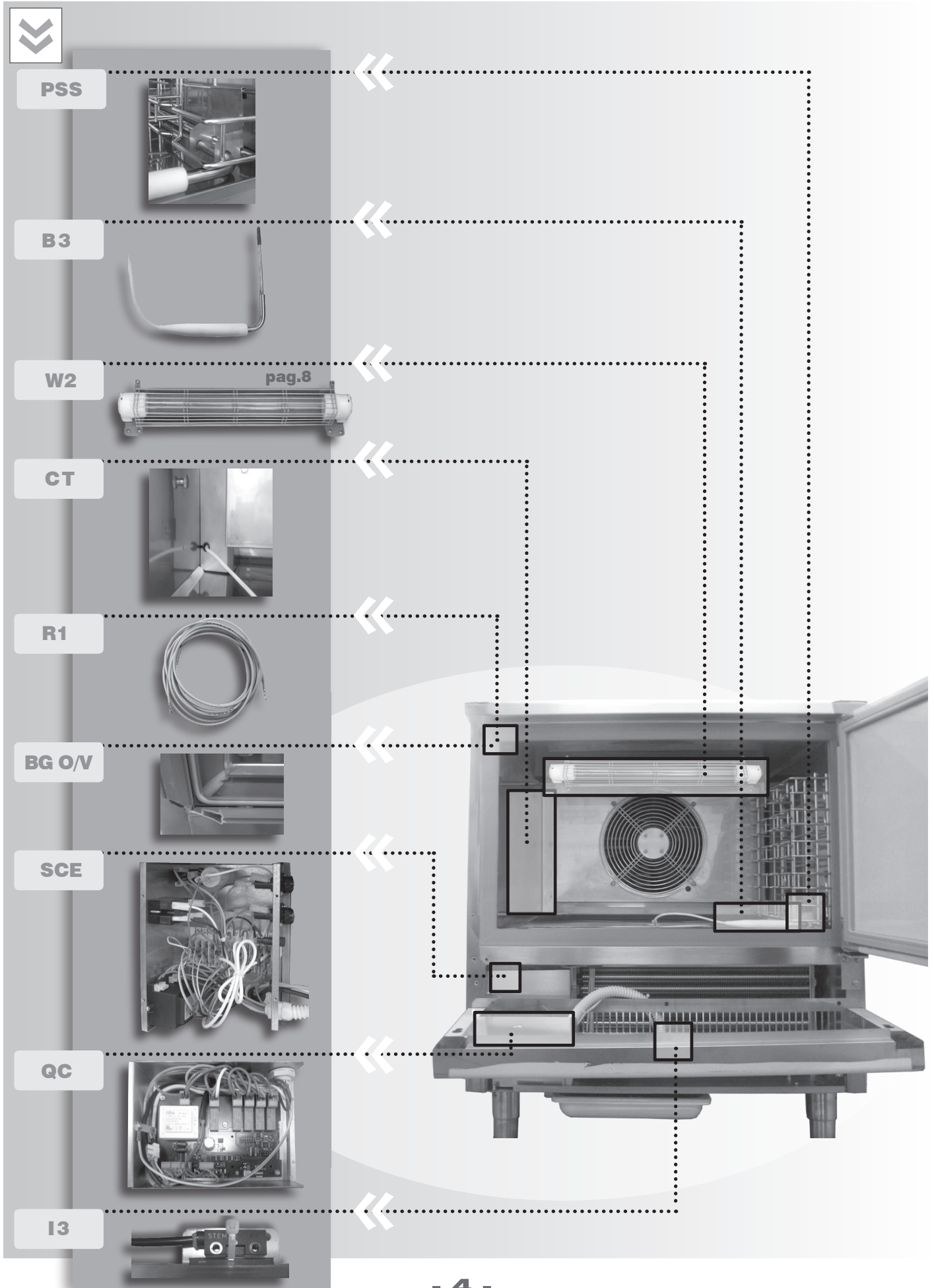

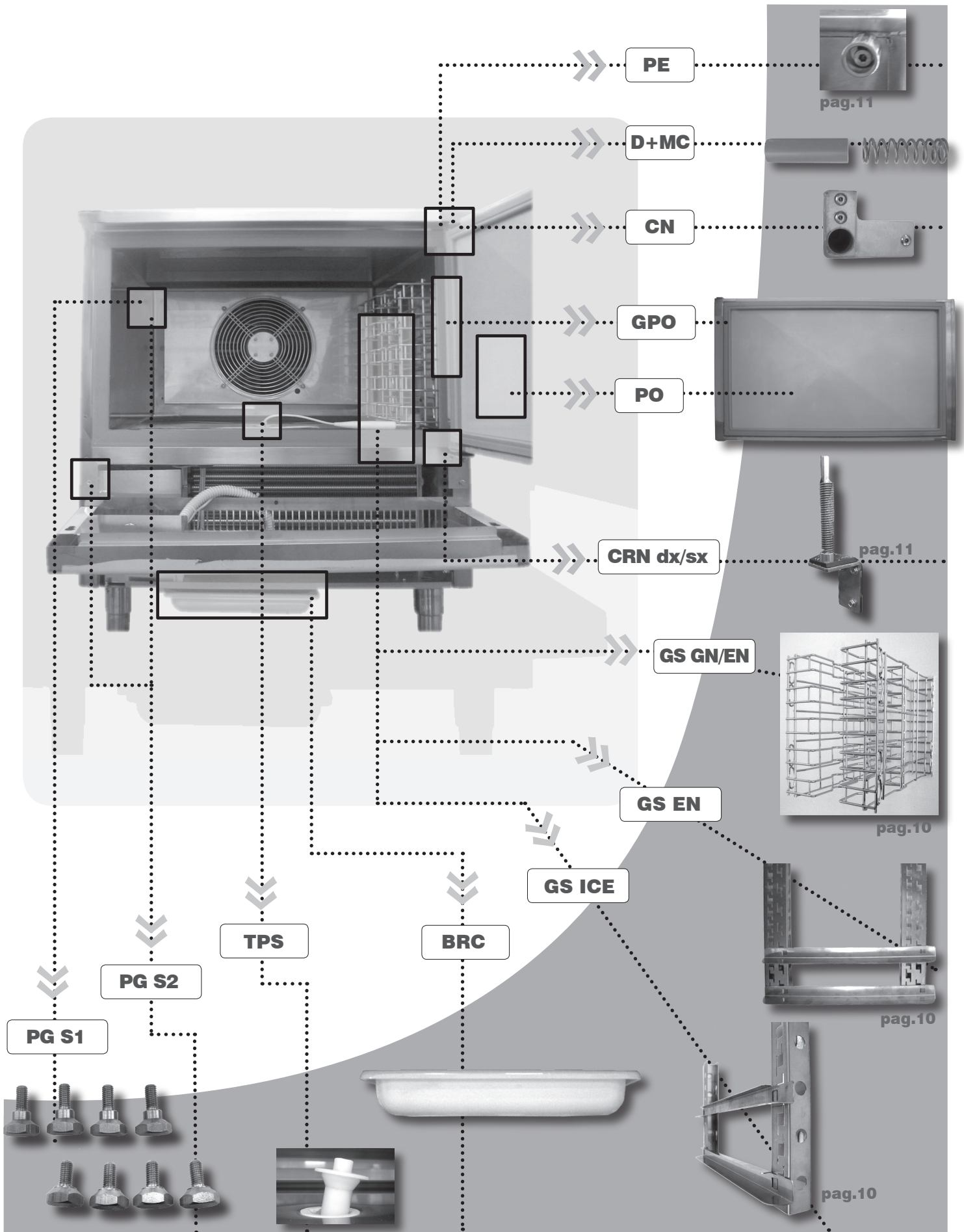

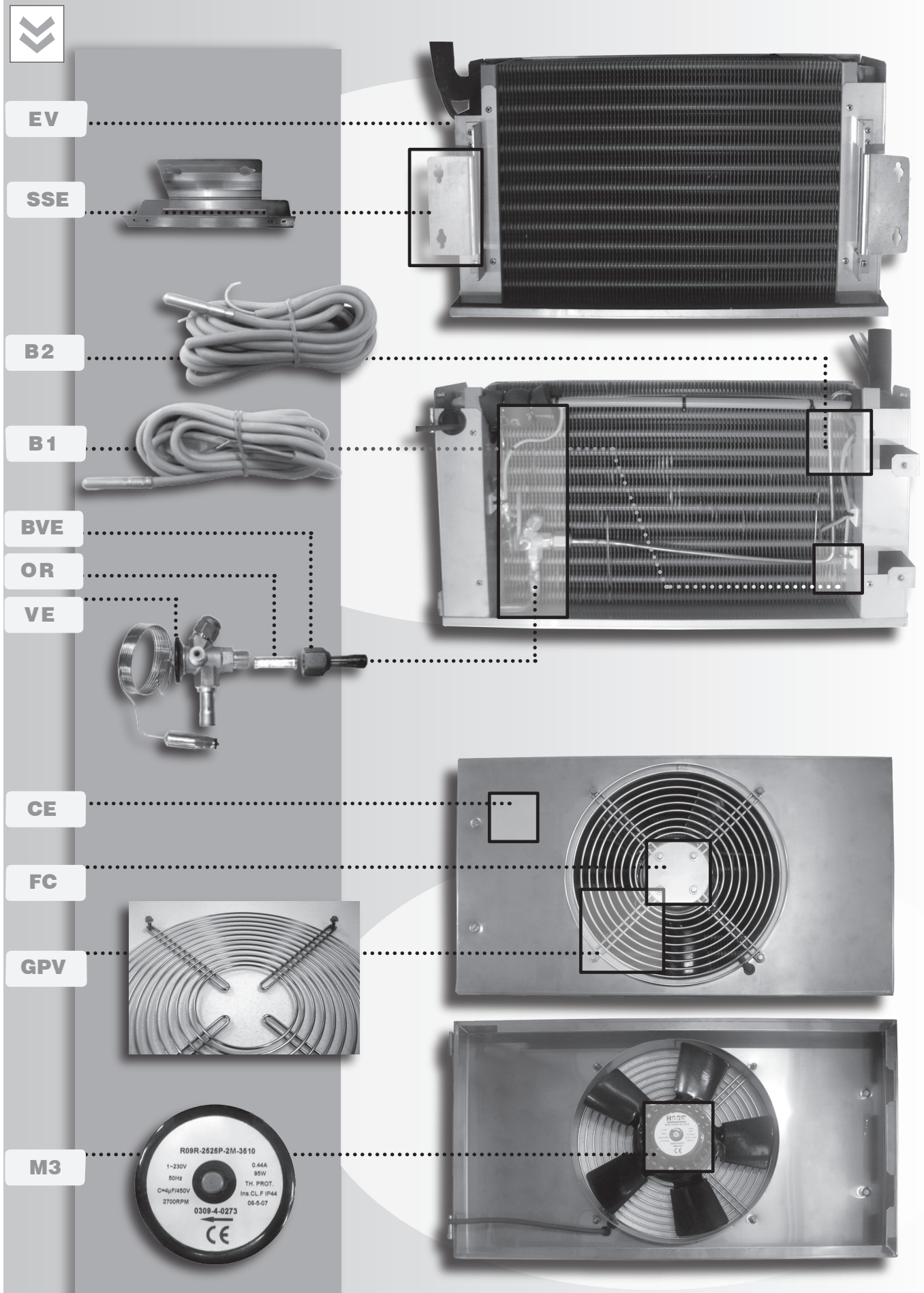

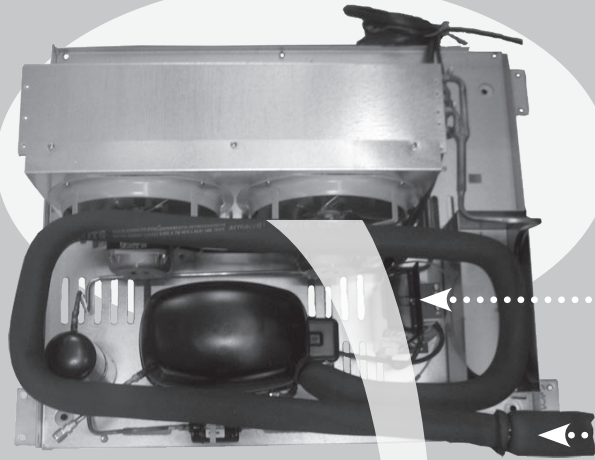

BOX/m1

TS

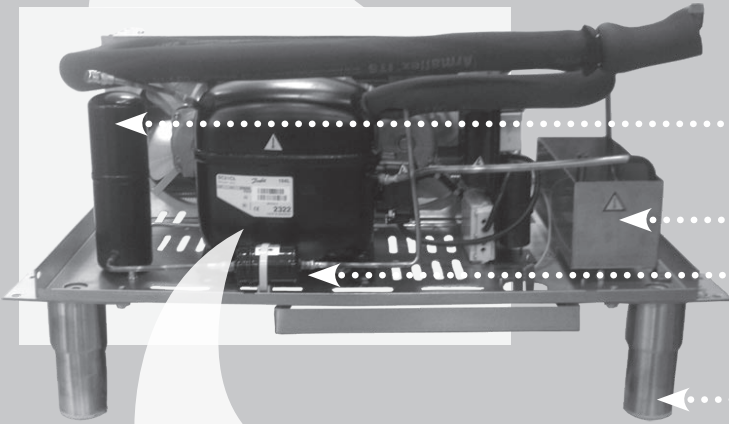

RL

VC

F

pag.10

PI/PR



M1



M2

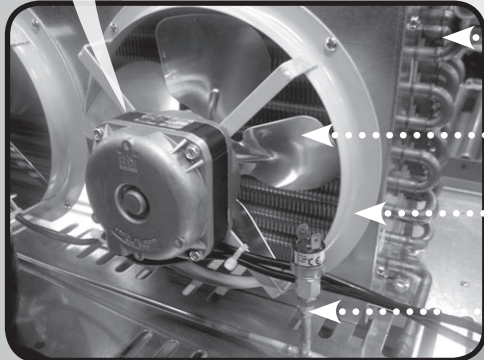

CO

M2 V

AV

P

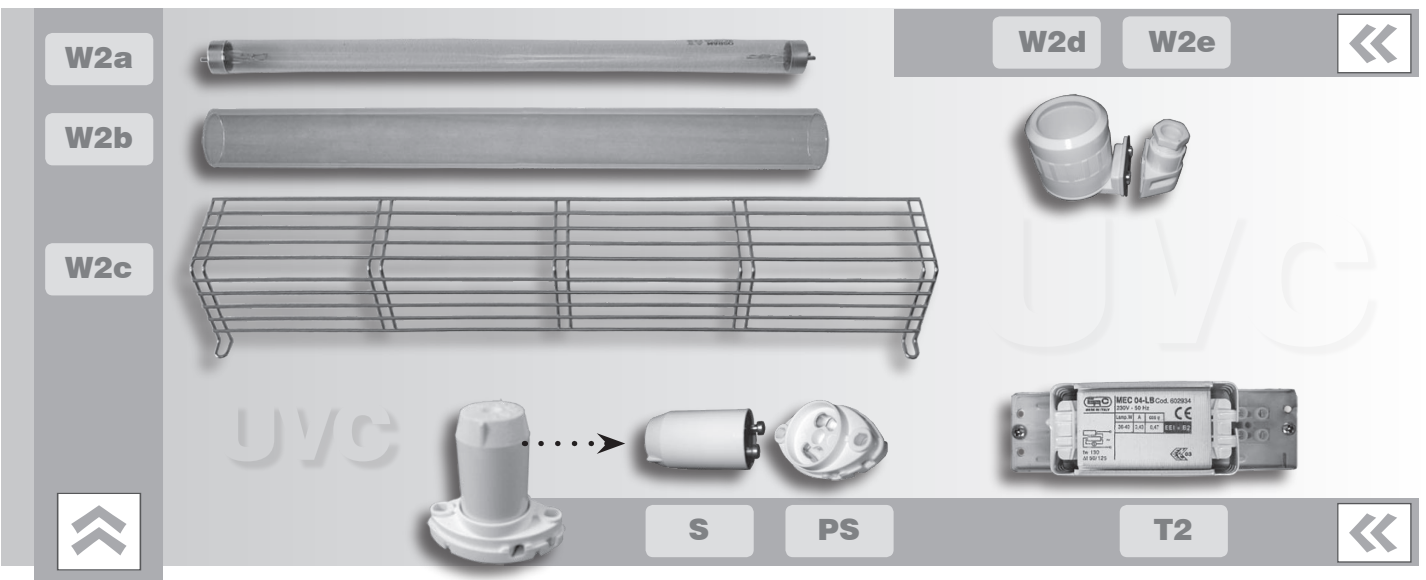
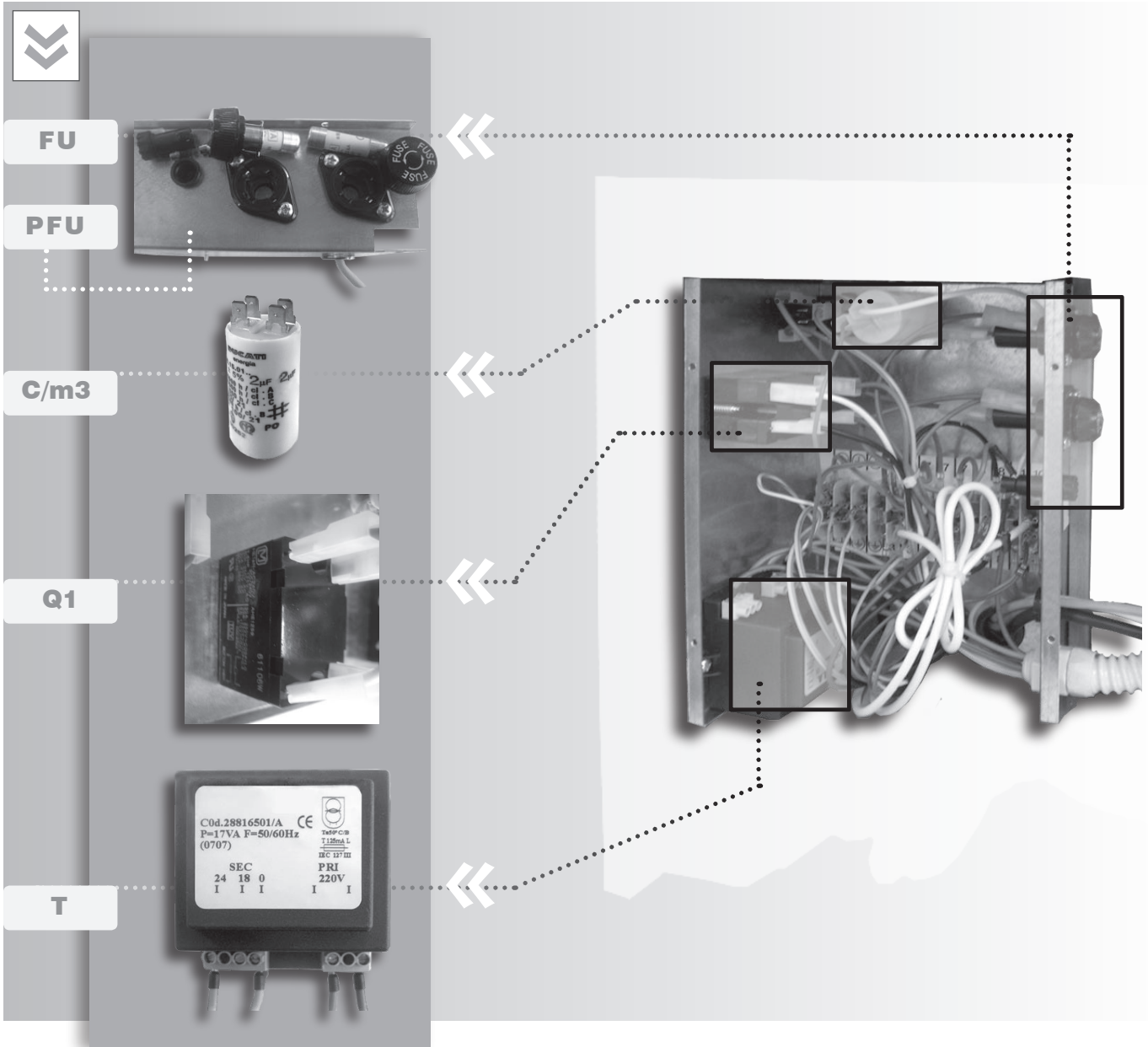

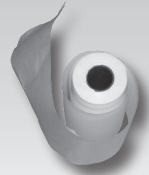

ST

CST

SST

RC

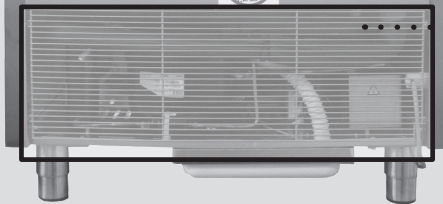

GPP



TS1

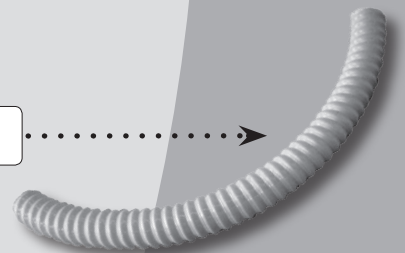

FTO



TS2

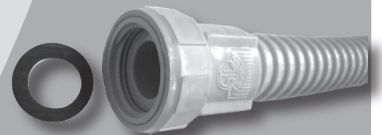

SB1

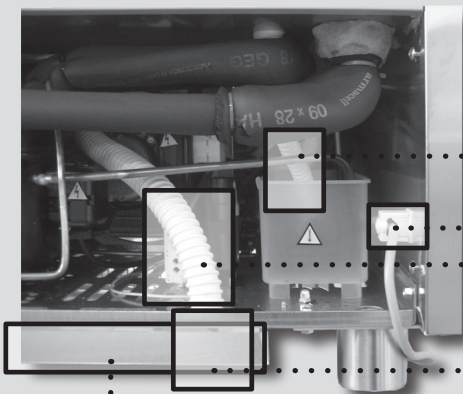

SB

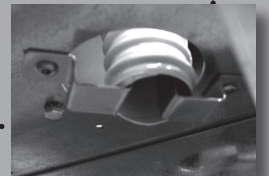
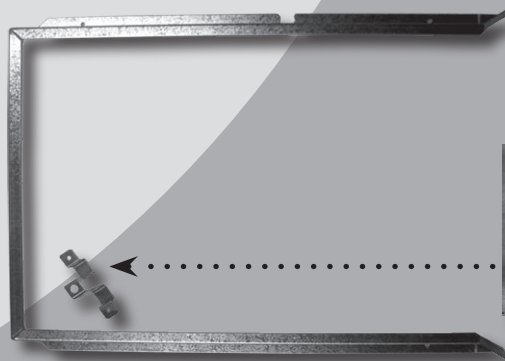



GS GN/EN

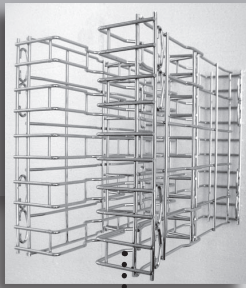

GS 1/2/3/4

GS EN

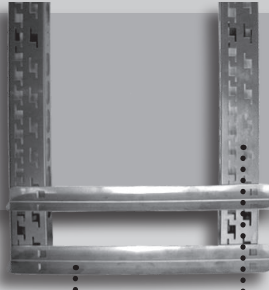

GL P 1/2/3/4 dx/sx

GS ICE

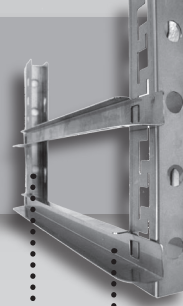

GC I 1/2/3/4 dx/sx

GS PG 1/2/3/4/5/6/7/8 dx/sx



PI1

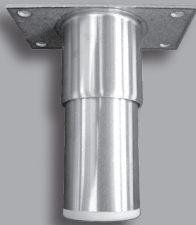

PI2



PI3



PI4



PI5



PI6



PI7



PRS1

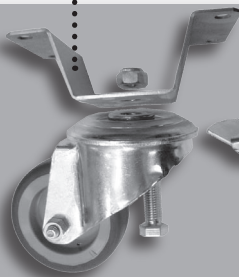

PRS2

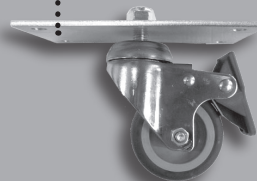

PR1/2

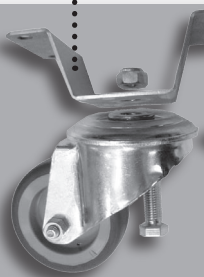

PR3

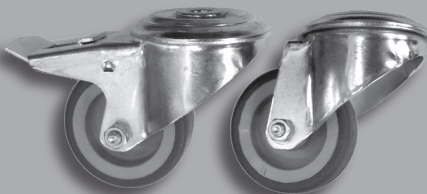

PR4



PR5/6

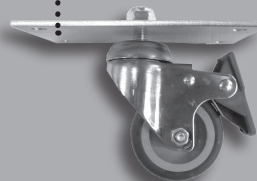

PR7



PR8



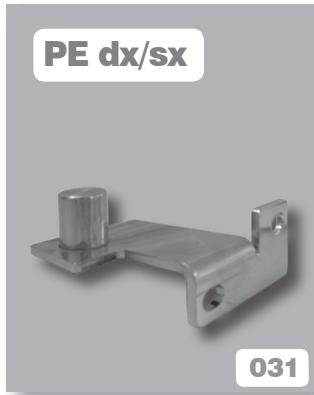

PE

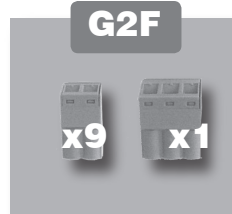
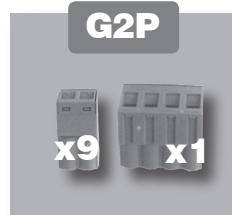
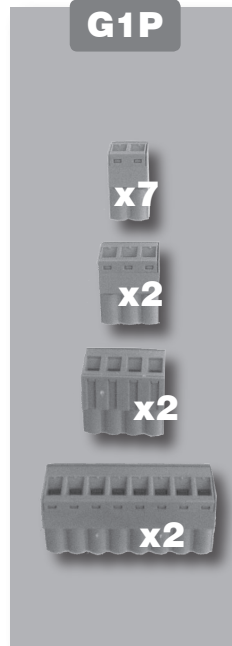
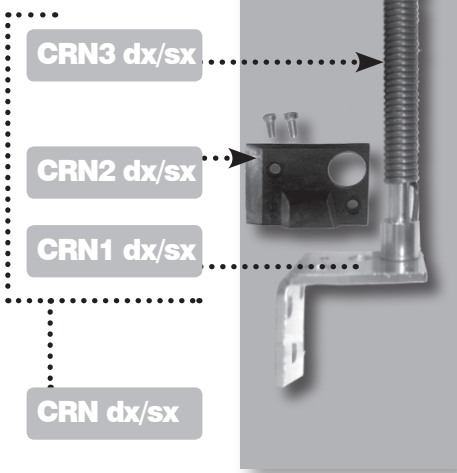

B08

B06

B04

B03

B02

B01



CRN

riferim. reference	codice code	descrizione description	modello model	da...a from...to	ricambi cons. rec. spare part
AC/M3	965438	COLLARE IN PLASTICA X CONV. D=250 PLASTIC RING FOR CONVEYOR D=250	051	__/__/__ 00/00/00	
AC/M3	965441	COLLARE IN PLASTICA X CONV. D=300 PLASTIC RING FOR CONVEYOR D=300	081 / 121 / 122	__/__/__ 00/00/00	
AV/M2	965324	ANELLO VENTILATORE ELC COND ABB ELECTRIC FAN RING ELCO COND. BLAST CHILLER	BF031A / BF051_ / B_081A / BF121D	03/03/07 00/00/00	
AV/M2	965346	ANELLO VENTIL ELC COND AB121 161 D=250 ELECTRIC FAN RING CON. BC121 161 D=250	121 / 161	__/__/__ 00/00/00	
B1	995562	SONDA PTC GRIGIA SILICONATA L=2500 CELLA PTC PROBE, GREY SILICONED L=2500 CABINET		01/01/95 00/00/00	<input type="checkbox"/>
B2	995500	SONDA PTC ROSSA SILICONATA L=2500 EVAPOR. PTC PROBE, RED SILICONED L=2500 EVAPORATOR		01/01/95 00/00/00	<input type="checkbox"/>
B3	965295	SONDA SPILL. PT1000 4 LIV 90° 5000 NON RISC. PIN PROBE PT1000 4 LIV 90° 5000 NO WARM	BC__P	22/02/07 00/00/00	<input type="checkbox"/>
B3	965296	SONDA SPILONE PT1000 4 LIV 90° 5000 RISC. PIN PROBE PT1000 4 LIV 90° 5000 WARM	BF__P	22/02/07 00/00/00	<input type="checkbox"/>
B3	996424	SONDA SPILL.PT1000 1 LIV.NO RIS 90°L=5 PIN PROBE PT1000 1 LIV. 90° 5000 NO WARM	BC__F	17/11/06 00/00/00	<input type="checkbox"/>
B3	996452	SONDA SPILONE PT1000 1 LIV 90° 5000 RISC. PIN PROBE PT1000 1 LIV 90° 5000 WARM	BF__F	16/01/07 00/00/00	<input type="checkbox"/>
BG O	965550	BATTUTA GUARNIZIONE AB L=737 ORIZZONTA HORIZONTAL PROF. FOR DOOR RABBET BC L=737		__/__/__ 00/00/00	
BG V	965551	BATTUTA GUARNIZIONE AB051 VERTICALE VERTICAL PROFILE FOR DOOR RABBET BC 051	051	__/__/__ 00/00/00	
BG V	965552	BATTUTA GUARNIZIONE AB081 VERTICALE VERTICAL PROFILE FOR DOOR RABBET BC 081	081	__/__/__ 00/00/00	
BG V	965553	BATTUTA GUARNIZIONE AB121 VERTICALE VERTICAL PROFILE FOR DOOR RABBET BC 121	121	__/__/__ 00/00/00	
BG V	965554	BATTUTA GUARNIZIONE AB161 VERTICALE VERTICAL PROFILE FOR DOOR RABBET BC 161	161	__/__/__ 00/00/00	
BG V	965558	BATTUTA GUARNIZIONE AB031 VERTICALE VERTICAL PROFILE FOR DOOR RABBET BC 031	031	__/__/__ 00/00/00	
BO1	996533	BOCCOLA PASSACAVO D=08 BUSH D=08		__/__/__ 00/00/00	
BO2	996534	BOCCOLA PASSACAVO D=12 BUSH D=12		__/__/__ 00/00/00	
BO3	996535	BOCCOLA PASSACAVO D=14 BUSH D=14		__/__/__ 00/00/00	
BO4	996536	BOCCOLA PASSACAVO D=19 BUSH D=19		__/__/__ 00/00/00	

riferim. reference	codice code	descrizione description	modello model	da...a from...to	ricambi cons. rec. spare part
BO6	996537	BOCCOLA PASSACAPO D=24 BUSH D=24		_/_/_ 00/00/00	
BO8	996538	BOCCOLA PASSACAPO D=42 BUSH D=42		_/_/_ 00/00/00	
BOX/M1	995978	BOX ELETTRICO ASPERA 'J9226GK' COMPRESSOR BOX ASPERA 'J9226GK'	BC081A	04/03/02 00/00/00	
BOX/M1	995979	BOX ELETTRICO ASPERA 'J2212GK' COMPRESSOR BOX ASPERA 'J2212GK'	BF081A / BF121D	04/03/02 00/00/00	
BOX/M1	996025	BOX ELETTRICO DANFOSS '117-7012' COMPRESSOR BOX DANFOSS '117-7012'	BF051_	22/05/00 00/00/00	
BRC	965283	BACINELLA RACC. CONENSA GN1/1 H50 PST NE BLACK BASIN GATHER CONDENS. GN1/1 H50 PST		22/02/07 00/00/00	
BV	996182	BOBINA HM2 230V 50/60HZ X VALV. SOLENOIDE COIL HM2 230V 50/60HZ FOR SOLENOID VALVE	051 / 081 / 121 / 161	09/01/03 00/00/00	□
BVE	965348	ADATTATORE VALV.ODF 10MM VALVE ADAPTER ODF 10MM		_/_/_ 00/00/00	
BVE	996539	ADATTATORE VALV.ODF 6MM VALVE ADAPTER ODF 6MM		_/_/_ 00/00/00	
C/M3	965315	CONDENSATORE ELETTR. 2,5MF 400V ELECTRIC CONDENSER 2,5MF 400V	081 / 121 / 161	26/02/07 00/00/00	
C/M3	996154	CONDENSATORE ELETTRICO MFP 2MF 400V ELECTRIC CONDENSER MFP 2MF 400V	031 / 051	28/08/02 00/00/00	
CE/M3	965349	CONVOGLIATORE BF031 EVAPORATOR COVERING BF031	031	_/_/_ 00/00/00	
CE/M3	965350	CONVOGLIATORE BF051 BF051 CONVEYOR	051	_/_/_ 00/00/00	
CE/M3	965351	CONVOGLIATORE BF081 BF081 CONVEYOR	081	_/_/_ 00/00/00	
CE/M3	965352	CONVOGLIATORE BF121 BF121 CONVEYOR	121	_/_/_ 00/00/00	
CE/M3	965353	CONVOGLIATORE BF161 BF161 CONVEYOR	161	_/_/_ 00/00/00	
CE/M3	965436	CONVOGLIATORE BF051 SENZA COLLARE EVAPORATORCONVEYOR BF051 WITHOUT RING	051	_/_/_ 00/00/00	
CE/M3	965439	CONVOGLIATORE BF121 SENZA COLLARI EVAPORATOR CONVEYOR BF121 WITHOUT RINGS	121	_/_/_ 00/00/00	
CE/M3	965442	CONVOGLIATORE BF161 SENZA COLLARI EVAPORATOR COVERING BF161 WITHOUT RINGS	161	_/_/_ 00/00/00	
CE/M3	965444	CONVOGLIATORE BF081 SENZA COLLARE EVAPORATOR CONVEYOR BF081 WITHOUT RING	081	_/_/_ 00/00/00	
CK	996496	BUZZER X SCHEDA EVCO EVCO CARD BUZZER		09/03/07 00/00/00	
CN	935723	CANNOTTO IN PLASTICA SUP. DX RIGHT UPPER PLASTIC TUBE		10/02/04 00/00/00	
CN	935724	CANNOTTO IN PLASTICA INF. DX RIGHT LOWER PLASTIC TUBE		10/02/04 00/00/00	
CO	965354	CONDENSATORE AB BC/BF081+ BC/BF121- BC BC/BF081+ BC/BF121 CONDENSER	B_081A / B_121D	_/_/_ 00/00/00	
CO	965355	CONDENSATORE BC161-2/3R BF161-2R BC/F1 BC161-2/3R BF161-2R BC/F1 CONDENSER	B_121A / BF161D / BC161A	_/_/_ 00/00/00	
CO	965356	CONDENSATORE BF161- BF122 BF161- BF122 CONDENSER	BF161A	_/_/_ 00/00/00	
CO	995117	CONDENSATORE 48 X 500 CONDENSER 48X500	BF031A / B_051_	01/01/95 00/00/00	

riferim. reference	codice code	descrizione description	modello model	da...a from...to	ricambi cons. rec. spare part
CR F	965722	ASS.CRUSC. ABB. 051 OLS PLRS BLAST CHILLER 051 FRONT PANEL OLS PLRS	031 / 051	26/11/07 00/00/00	
CRI	965460	PARTE INFERIORE ABB 121 OLIS POLARIS LOWER FRONTAL PANEL B.CHILLER OLIS POLARIS	121	13/07/07 00/00/00	
CRI	965501	PARTE INFERIORE ABB 161 POLARIS LOWER PANEL BLAST CHILLER 161 POLARIS	161	14/02/07 00/00/00	
CRI	965723	PARTE INF. CRUSCOTTO ABB. 081 PLRS LOWER FRONTAL PANEL B. CHILLER 081 PLRS	081	26/11/07 00/00/00	
CRN DX	965548	KIT CERNIERA INF.DX AB031-051-081-121-161 RIGHT LOWER HINGE KIT BC 031-051-081-121- 161		_/_/_- 00/00/00	
CRN SX	965549	KIT CERNIERA INF.SX AB031-051-081-121-161 LEFT LOWER HINGE KIT BC 031-051-081-121- 161		_/_/_- 00/00/00	
CRN1 DX	965240	ASS.CERNIERA INF. DX ABB. NEW LOWER RIGHT HINGE KIT BLAST CHILLER NEW		16/01/07 00/00/00	
CRN1 SX	996433	ASS.CERNIERA INF.SX ABB 051 LOWER LEFT HINGE KIT 051 BC		16/01/07 00/00/00	
CRN2 DX	935715	PIASTRA FERMO PORTA 'DX' 'PV' AR MNSC RIGHT DOOR STOP PLATE 'PV' MNSC CABINET		19/09/03 00/00/00	
CRN2 SX	935714	PIASTRA FERMO PORTA 'SX' 'PV' AR MNSC LEFT DOOR STOP PLATE 'PV' MNSC CABINET		19/09/03 00/00/00	
CRN3 DX	935697	MOLLA PORTA SX ARMADI CANOTTO IN ABS LEFT DOOR SPRING FOR ABS PLASTIC TUBE		15/04/03 00/00/00	
CRN3 SX	935696	MOLLA PORTA DX ARMADI CANOTTO IN ABS RIGHT DOOR SPRING FOR ABS PLASTIC TUBE		15/04/03 00/00/00	
CRS F	965359	CRUSCOTTO ABB FAST FRX CON SCATOLA COM BLAST CHILLER FRONTAL PANEL FAST WITH BOX	081 / 121 / 161 F	01/01/95 00/00/00	
CRS F - ST	965570	ASS.CRUSCOTTO 081->161 STD FRX C/FO ST FRONTAL PANEL FAST STD FRX WITH PRINT.HOLE	081 / 121 / 161 F	_/_/_- 00/00/00	
CRS P	965358	CRUSCOTTO ABB PLUS FRX CON SCATOLA COM 081-121-161 B.C. FRONTAL PANEL PLUS FRX	081 / 121 / 161 P	_/_/_- 00/00/00	
CRS P - ST	965569	ASS.CRUSCOTTO 081->161 TOP FRX C/FO ST FR.PANEL F B081->161 TOP FRX WITH PRIN.HOLE	081 / 121 / 161 P	_/_/_- 00/00/00	
CST	996492	COPERCHIO PLEX.PROTEZ.STP EVCO PLEXIGLASS COVER FOR EVCO PRINTER		02/03/07 00/00/00	
CT	965284	COPERTURA INOX TUBI EVAP. ABB. INOX COVERING TUBES EVAPORATOR B.CHILLER		22/02/07 00/00/00	

riferim. reference	codice code	descrizione description	modello model	da...a from...to	ricambi cons. rec. spare part
DI	996572	DISTANZ.D=15 L=50 PVC PER CERN.SUP.ABB PVC SPACER D=15 L=50 FOR UPPER HINGE B.C.		__/__/__ 00/00/00	
DIS	925500	DISTANZIALE SCHIENALE TRS MC DONALD'S BACK SPACER TRS MC DONALD'S		__/__/__ 00/00/00	
EV	965289	BATTERIA EVAPORANTE ABB.051-7 3RANGHI EVAPORATOR BATTERY B.CHILLER 051-7 3 ROWS	051A	22/02/07 00/00/00	
EV	965290	BATTERIA EVAPORANTE ABB.051-7 2RANGHI EVAPORATOR BATTERY B.CHILLER 051-7 2 ROWS	051D	22/02/07 00/00/00	
EV	965360	BATTERIA EVAPORANTE ABB081 3R EVAPORATOR BATTERY B.CHILLER 081 3 ROWS	081A	__/__/__ 00/00/00	
EV	965361	BATTERIA EVAPORANTE ABB121 3R EVAPORATOR BATTERY B.CHILLER 121 3 ROWS	121A	__/__/__ 00/00/00	
EV	965375	BATTERIA EVAPORANTE ABB161 2R EVAPORATOR BATTERY B.CHILLER 161 2 ROWS	161D	__/__/__ 00/00/00	
EV	965376	BATTERIA EVAPORANTE ABB041 3R EVAPORATOR BATTERY B.CHILLER 041 3 ROWS	031A	__/__/__ 00/00/00	
EV	965650	BATTERIA EVAPORANTE ABB161 3RANGHI EVAPORATOR BATTERY BC161 THREE ROWS	161A	__/__/__ 00/00/00	
F	995690	FILTRO DISIDRATATORE ODF DML032S 023Z455 DEHYDRATOR FILTER ODF DML032S 023Z455	031 / 051 / 081	02/05/04 00/00/00	
F	996269	FILTRO DISIDRATATORE ODF DML033S 023Z455 DEHYDRATOR FILTER ODF DML033S 023Z455	121 / 161	07/09/04 00/00/00	
FC	996364	FONDELLO COPERTURA ROTORE VENT. D=300 BOTTOM COVERING ROTOR FAN D=300		27/03/06 00/00/00	
FTO	965308	FISSATUBO OBO 3040 LGK D=6-16 MM OBO CLIP 3040 LGK D=6-16 MM		23/02/07 00/00/00	
FU	995919	FUSIBILE 10A AM 10X38 ABB.1F FUSE 10A AM 10X38 BC 1F		02/08/06 00/00/00	<input type="checkbox"/>
G1/G2/G6P	996383	ASSIEME SCHEDA ELETTR. TOP FRX ABB/CONG. ELECTRIC CARD ASSEMBLY TOP FRX BC/BF	PLUS	26/05/06 12/09/07	<input type="checkbox"/>
	996594	ASSIEME SCHEDA EVCO AB PLUS-FRX 128K ELECTRIC CARD ASS. EVCO BC PLUS FRX 128K	PLUS	13/09/07 00/00/00	<input type="checkbox"/>
G1F	996384	ASSIEME SCHEDA ELETTR. STD FRX ABB/CONG. ELECTRIC CARD ASSEMBLY STD FRX BC/BF	FAST	26/05/06 00/00/00	<input type="checkbox"/>
G1P	996380	SCHEDA POTENZA TOP ABB/CONG. POWER CARD TOP BC/BC	PLUS	26/05/06 12/09/07	<input type="checkbox"/>
	996595	SCHEDA POTENZA EVCO AB FRX-HIB C/PWM POWER CARD EVCO BC FRX-HIB C/PWM	PLUS	13/09/07 00/00/00	<input type="checkbox"/>

riferim. reference	codice code	descrizione description	modello model	da...a from...to	ricambi cons. rec. spare part
G2P	996381	SCHEDA TASTIERA TOP FRX ABB/CONG. KEYBOARD CARD TOP FRX BC/BF	PLUS	26/05/06 12/09/07	<input type="checkbox"/>
	996593	SCHEDA TASTIERA EVCO TOP FRX 128K KEYBOARD CARD EVCO TOP FRX 128K	PLUS	10/03/08 00/00/00	<input type="checkbox"/>
G4	990584	KIT STAMPANTE ABB 051 PRINTER KIT BC 051		_/_/_- 00/00/00	
G5	996606	SCHEDA ESPANSIONE TAGLIO FASE 600W 50H EXPANSION ENCODER CUTTING PHASE 600W 50H	PLUS	_/_/_- 00/00/00	<input type="checkbox"/>
G6P	996382	SCHEDA ENCODER TOP FRX ABB/CONG. ENCODER CARD TOP FRX BC/BF	PLUS	26/05/06 00/00/00	<input type="checkbox"/>
GC I	935966	COPPIA GUIDE A "C"25X40X360.5 GELATO PAIR OF TELESC. GUIDES "C" 25X40X360.5 ICE	031 / 051	_/_/_- 00/00/00	
GC I	935967	COPPIA GUIDE A "C"25X25X390 GELATO PAIR OF TELESCOPIC GUIDES "C" 25X25X390 ICE	081 / 121 / 161	_/_/_- 00/00/00	
GC I1	965377	GUIDA A "C" AB L360 DX GELATERIA RIGHT "C" SLIDE AB L360 ICE-CREAM	031 / 051	_/_/_- 00/00/00	
GC I1	965378	GUIDA A "C" AB L360 SX GELATERIA LEFT "C" SLIDE AB L360 ICE-CREAM	031 / 051	_/_/_- 00/00/00	
GC I2	965379	GUIDA A "C" AB L390 DX GELATERIA RIGHT "C" SLIDE AB L390ICE-CREAM	081 / 121 / 161	_/_/_- 00/00/00	
GC I2	965380	GUIDA A "C" AB L390 SX GELATERIA LEFT "C" SLIDE AB L390 ICE-CREAM	081 / 121 / 161	_/_/_- 00/00/00	
GL P	935957	COPPIA GUIDE A "L"40X25X390 ABB081-161 PAIR OF GUIDES "L" 40X25X390 BC 081-161	081 / 121 / 161	15/09/06 00/00/00	
GL P	996447	COPPIA GUIDE "L" ABB.051 DX+SX PASTICC PAIR OF GUIDES "L" BC051 RIGHT&LEFT PASTRY	031 / 051	09/01/07 00/00/00	
GL P1	965383	GUIDA A "L" AB L360 DX ABB RUGHT "L" SLIDE L360 BLAST CHILLER	031 / 051	_/_/_- 00/00/00	
GL P1	965384	GUIDA A "L" AB L360 SX ABB LEFT "L" SLIDE L360 BLAST CHILLER	031 / 051	_/_/_- 00/00/00	
GL P2	965381	GUIDA A "L" AB L390 DX ABB RIGHT "L" SLIDE L390 BLAST CHILLER	081 / 121 / 161	_/_/_- 00/00/00	
GL P2	965382	GUIDA A "L" AB L390 SX ABB LEFT "L" SLIDE AB L390 BLAST CHILLER	081 / 121 / 161	_/_/_- 00/00/00	
GPO	965298	GUARN.PORTA BF081 650X690 DOOR GASKET BF081 650X690	081	_/_/_- 00/00/00	<input type="checkbox"/>
GPO	965299	GUARNIZIONE PORTA BF161 1130X690 DOOR GASKET BF161 1130X690	161	_/_/_- 00/00/00	<input type="checkbox"/>
GPO	965385	GUARN.PORTA BF031 DOOR GASKET BF031	031	_/_/_- 00/00/00	<input type="checkbox"/>
GPO	996453	NN01 GUARNIZIONE PORTA BF051 400X690 NN01 DOOR GASKET BF051 400X690	051	_/_/_- 00/00/00	<input type="checkbox"/>
GPO	996457	NN01 GUARN.PORTA BF121 850X690 NN01 DOOR GASKET BF121 850X690	121	_/_/_- 00/00/00	<input type="checkbox"/>
GPP	965292	GRIGLIA DI PROTEZIONE POSTER. ABB.051 BACK GRID PROTECTION BLAST CHILLER 051	031 / 051	22/02/07 00/00/00	
GPP	965386	GRIGLIA DI PROTEZ.POSTER. ABB.081 BACK GRID PROTECTION BLAST CHILLER 081	081	_/_/_- 00/00/00	
GPP	965387	GRIGLIA DI PROTEZ.POSTER. ABB.121 BACK GRID PROTECTION BLAST CHILLER 121	121	_/_/_- 00/00/00	

referim. reference	codice code	descrizione description	modello model	da...a from...to	ricambi cons. rec. spare part
GPP	965388	GRIGLIA DI PROTEZ.POSTER. ABB.161 BACK GRID PROTECTION BLAST CHILLER 161	161	__/__/__ 00/00/00	
GPV	965309	GRIGLIA PROTEZIONE VENTOLA EVAP.051 D250 BLADE EVAPORATOR PROTECTION GRID 051 D250	051	26/02/07 00/00/00	
GPV	965310	GRIGLIA PROTEZ.VENT.EVAP.081 D300 BLADE EVAPORATOR GRID PROTECTION 081 D300	081	26/02/07 00/00/00	
GPV	995753	GRIGLIA METALLICA VENTILAT.'ECOFIT' METAL GRID 'ECOFIT' FAN	031	18/09/96 00/00/00	
GPV	995991	GRIGLIA PROT. VENTILATORE D=300 ABBATT FAN GRID PROTECTION D=300 BLAST CHILLER	081 / 121 / 161	21/02/05 00/00/00	
GPV	996601	GRIGLIA PROT.VENT.EBM D=300 AB FAN GRID PROTECTION EBM D=300 BL. CHILLER	081 / 121 / 161	__/__/__ 00/00/00	
GS PG0	965644	MONTANTE DX GN ABB 031 RIGHT UPRIGHT GN BLAST CHILLER 031	031 GN	__/__/__ 00/00/00	
GS PG0	965645	MONTANTE SX GN ABB 031 LEFT UPRIGHT GN BLAST CHILLER 031	031 GN	__/__/__ 00/00/00	
GS PG0	965655	MONTANTE DX 041 EN RIGHT UPRIGHT 041 EN	031 EN / ICE	__/__/__ 00/00/00	
GS PG0	965656	MONTANTE SX 041 EN LEFT UPRIGHT 041 EN	031 EN / ICE	__/__/__ 00/00/00	
GS PG1	935970	ASS.MONT.DX PORTASPILLONE AB051 EN RIGHT UPRIGHT PROBE-HOLDER B.C. 051 EN	051 EN	08/01/07 00/00/00	
GS PG1	996446	ASS.MONT.SX BF051 EN LEFT UPRIGHT BF051 EN	051 EN	09/01/07 00/00/00	
GS PG2	965392	MONTANTE DX BF081 EN RIGHT UPRIGHT BF081 EN	081 EN	__/__/__ 00/00/00	
GS PG2	965393	MONTANTE SX BF081 EN LEFT UPRIGHT BF081 EN	081 EN	__/__/__ 00/00/00	
GS PG3	965394	MONTANTE SX BF121 EN LEFT UPRIGHT BF121 EN	121 EN	__/__/__ 00/00/00	
GS PG3	965395	MONTANTE DX BF121 EN RIGHT UPRIGHT BF121 EN	121 EN	__/__/__ 00/00/00	
GS PG4	965396	MONTANTE DX BF161 EN RIGHT UPRIGHT BF161 EN	161 EN	__/__/__ 00/00/00	
GS PG4	965397	MONTANTE SX BF161 EN LEFT UPRIGHT BF161 EN	161 EN	__/__/__ 00/00/00	
GS1	965286	STRUTT.PORTAT.IN TOND.DX/SX ABB.051 RIGHT/LEFT ROD FRAME TRAY HOLDER B.C. 051	031 / 051	22/02/07 00/00/00	
GS2	965389	STRUTT.PORTAT.IN TOND.DX/SX ABB.081 RIGHT/LEFT ROD FRAME TRAY HOLDER B.C. 081	081	__/__/__ 00/00/00	
GS3	965390	STRUTT.PORTAT.IN TOND.DX/SX ABB.121 RIGHT/LEFT ROD FRAME TRAY HOLDER B.C. 121	121	__/__/__ 00/00/00	
GS4	965391	STRUTT.PORTAT.IN TOND.DX/SX ABB.161 RIGHT/LEFT ROD FRAME TRAY HOLDER B.C. 161	161	__/__/__ 00/00/00	
I3	995405	MICROPORTA MAGNETICO STEM E510 MAGNETIC MICRO-SWITCH STEM E510		01/01/95 00/00/00	<input type="checkbox"/>
IS	996441	SCHEDINA SERIALE X SIST.FAST AGGIUNTIVA PRINTER KIT FOR ADDICTIONAL FAST SISTEM	FAST	22/12/06 00/00/00	<input type="checkbox"/>

referim. reference	codice code	descrizione description	modello model	da...a from...to	ricambi cons. rec. spare part
K1	965694	CONTATTORE MOELLER DIL EM-10 BOB.230V CONTACTOR TELEMECAn. DIL EM-10 BOB.230V	121A / 161	__/__/00 00/00/00	<input type="checkbox"/>
KIT M2	965318	ASS. VENTIL. ELCO D=200-34°-VNT10-20+CON ELCO FAN D=200-34°-VNT10-20+CON	041 / 051 / 081	26/02/07 00/00/00	<input type="checkbox"/>
KIT M2	965319	ASS. VENTIL. ELCO D=254-34°-VNT35-45+CON ELCO FAN D=254-34°-VNT35-45+CON	121 / 161	26/02/07 00/00/00	<input type="checkbox"/>
M1	965326	COMPRESSORE ABB BF161+122-TEC TAG2516Z B.C. BF161+122-TEC TAG2516Z COMPRESSOR	BF161A	16/03/07 00/00/00	
M1	965362	COMPRESSORE U.H TFH4531Z R404A 400V U.H TFH4531Z R404A 400V COMPRESSOR	BC161A	__/__/00 00/00/00	
M1	965398	COMPRESSORE ASPERA T6217GK R404A T6217GK R404A ASPERA COMPRESSOR	BC051A	__/__/00 00/00/00	
M1	965399	COMPRESSORE TFH2511Z-K UL 208/3/60 TFH2511Z-K UL 208/3/60 COMPRESSOR	BF121A / BF161D	__/__/00 00/00/00	
M1	995711	COMPRESSORE 34,37CC J2212GK CSR R404A 34,37CC J2212GK CSR R404A COMPRESSOR	BF081A / BF121D	01/01/95 00/00/00	
M1	995745	COMPRESSORE 17,4 CC T2168GK/SC15CL R40 17,4 CC T2168GK/SC15CL R40 COMPRESSOR	031A	01/03/98 00/00/00	
M1	995746	COMPRESSORE 20,4 CC T2178GK/SC18CL R40 20,4 CC T2178GK/SC18CL R40 COMPRESSOR	BF051D	16/02/99 00/00/00	
M1	995770	COMPRESSORE 22,4 CC.T2180GK-SC21CL R40 22,4 CC.T2180GK-SC21CL R40 COMPRESSOR	BF051A	30/04/97 00/00/00	
M1	995925	COMPRESSORE 21,7 CC J9226GK CSR R404A 21,7 CC J9226GK CSR R404A COMPRESSOR	BC081A / BC121D	23/10/98 00/00/00	
M1	995926	COMPRESSORE J9238GS R404A J9238GS R404A COMPRESSOR	BC121A / BC161D	25/01/99 00/00/00	
M1	996391	COMPRESSORE ASPERA NE9213 GK R404A NE9213 GK R404A ASPERA COMPRESSOR	BC051D	03/07/06 00/00/00	
M2	965781	MOTORE CONDENSATORE ELC PER VENT D=254 CONDENSER FAN ELC D=254	121 / 161	__/__/00 00/00/00	<input type="checkbox"/>
M2	965782	MOTORE CONDENSATORE ELC PER VENT D=200 CONDENSER FAN ELC =200	041 / 051 / 081	__/__/00 00/00/00	<input type="checkbox"/>
M2 V	965325	VENTOLA VENTILATORE ELC COND. ABB.051 BLADE FAN ELC COND. BLAST CHILLER 501	031 / 051 / 081	03/03/07 00/00/00	<input type="checkbox"/>
M2 V	965780	VENTOLA CONDENSATORE ELC D=254 CONDENSER FAN ELC D=254	121 / 161	__/__/00 00/00/00	<input type="checkbox"/>
M3	965313	VENT. ROTOMATIKA D250 2P R09R-2525P-2M- 351 ROTOMATIKA FAN D250 2P R09R-2525P-2M- 351	051	26/02/07 00/00/00	<input type="checkbox"/>

riferim. reference	codice code	descrizione description	modello model	da...a from...to	ricambi cons. rec. spare part
M3	965314	VENT. ROTOMATIKA D300 4P R09R-3028P-4M-3508 ROTOMATIKA FAN D300 4P R09R-3028P-4M-3508	081 / 121 / 161	01/01/07 28/01/07	<input type="checkbox"/>
	995870	VENTILATORE EVAPORATORE D=300 MONOFASE EVAPORATOR FAN D=300 MONO-PHASIC		29/01/07 00/00/00	<input type="checkbox"/>
M3	995910	VENTILATORE ASSIALE 2VRE15 200A AXIAL FAN 2VRE15 200A	031	08/10/98 00/00/00	<input type="checkbox"/>
MAS1	965434	MASCHERINA COMANDI ABB. STD (PLS) CONTROL PANEL BLAST CHILLER STD (PLS)	FAST	14/06/07 00/00/00	
MAS2	965435	MASCHERINA COMANDI ABB. TOP (PLS) CONTROL PANEL BLAST CHILLER TOP (PLS)	PLUS	14/06/07 00/00/00	
MC	925598	MOLLA X CERNIERA AUTOC.CRUS.TR H=650 HINGE DOOR SPRING SELF-LOCK TR H=650		11/12/02 00/00/00	
ME	965171	MANOPOLA ENCODER SCHEDE ABBATTITORE ENCODER KNOB FOR BLAST CHILLER	PLUS	16/11/04 00/00/00	<input type="checkbox"/>
OR	996263	ORIFIZIO N°01 ODF DANFOSS N.01 ORIFICE ODF DANFOSS	BF031A / B_051_	07/09/04 00/00/00	
OR	996264	ORIFIZIO N°02 ODF DANFOSS N.02 ORIFICE ODF DANFOSS	B_081A / BF121D / BC121A	07/09/04 00/00/00	
OR	996265	ORIFIZIO N°03 ODF DANFOSS N.03 ORIFICE ODF DANFOSS	BF121A / BC161A / BF161_	07/09/04 00/00/00	
P	996449	PRESSOSTATO DANFOSS CB 061F8486 ACB2UB136 DANF. PRESS, SWITCH CB 061F8486 ACB2UB136		16/01/07 00/00/00	<input type="checkbox"/>
PE	965282	PERNO CON ASOLA CERNIERA SUP ABB. UPPER SLOT PIN HINGE BLAST CHILLER	051 / 081 / 121 / 161	22/02/07 00/00/00	
PE dx	965524	ASS.CERNIERA SUP.DX ABB. BF 031/41 UPPER RIGHT HINGE BLAST CHILLER BF 031	031	_/_/_ 00/00/00	
PE sx	965523	ASS.CERNIERA SUP.SX ABB. BF 031/41 UPPER LEFT HINGE BLAST CHILLER BF 031	031	_/_/_ 00/00/00	
PFU	996088	PORTAFUS HK10380 X FU10X38 WEBER 1POLO FUSE-CARRIER 10X38 FOR FU10X38 WEBER 1 POLE		25/09/01 00/00/00	
PG S1	965307	PERNO FILETTATO AGG. MONTANTI ABB. NEW THREADED PIN FOR COUPLER UPRIGHTS B.C. NEW	GN	23/02/07 00/00/00	
PG S2	995493	PERNO FILETTATO X MONTANTI ABB. THREADED PIN FOR UPRIGHTS BLAST CHILLER	EN	01/01/95 00/00/00	
PI1	990581	ASS.PIEDINO 2' FOOT ASSEMBLY 2'	081 / 121 / 161	_/_/_ 00/00/00	
PI2	995012	PIEDE INOX LISCIO DA 2"G AR MNSC SMOOTH FOOT INOX 2"G MNSC CABINET	081 / 121 / 161	01/01/95 00/00/00	
PI3	990582	TAPPO X PIEDE 2' PVC GRIGIO GREY FOOT PLUG 2' PVC	081 / 121 / 161	_/_/_ 00/00/00	
PI4	995011	SUPPORTO PIEDE INOX AR MNSC FOOT SUPPORT INOX MNSC CABINET		01/01/95 00/00/00	
PI5	965347	TAPPO X PIEDE 2' PVC NERO BLACK FOOT 2' PLUG	031 / 051	_/_/_ 00/00/00	
PI6	965365	PIEDE INOX 2' GAS L=75 ABB 051 NOX FOOT 2' GAS L=75 ABB 051	031 / 051	_/_/_ 00/00/00	

riferim. reference	codice code	descrizione description	modello model	da...a from...to	ricambi cons. rec. spare part
PI7	965237	ASS.PIED. INOX 2'REG 78/110 AA69ECNR8CAN INOX FOOT ASS. 2'REG 78/110 AA69ECNR8CAN	031 / 051	11/12/06 00/00/00	
PO	965246	ASS.PORTA SCHIUMATA BF051 2007 DOOR FOR BF051 BLAST CHILLER 2007	051	23/01/07 00/00/00	
PO	965366	PORTA SCHIUMATA ABB 041 DOOR FOR 041 BLAST CHILLER	031	_/_/_- 00/00/00	
PO	965367	PORTA SCHIUMATA ABB 081 DOOR FOR 081 BLAST CHILLER	081	_/_/_- 00/00/00	
PO	965369	PORTA SCHIUMATA ABB 121 DOOR FOR 121 BLAST CHILLER	121	_/_/_- 00/00/00	
PO	965371	PORTA SCHIUMATA ABB 161 DOOR FOR 161 BLAST CHILLER	161	_/_/_- 00/00/00	
PR1	996545	ASS. RUOTA ANTERIORE C/FRENO D=80 FRONT CASTOR WITH BRAKE D=80	081 / 121 / 161	_/_/_- 00/00/00	
PR2	996546	ASS. RUOTA ANTERIORE S/FRENO D=80 FRONT CASTOR WITHOUT BRAKE D=80	081 / 121 / 161	_/_/_- 00/00/00	
PR3	996015	RUOTA GIREVOLE D=80 CON FRENO REVOLVING CASTOR D=80 WITH BRAKE	081 / 121 / 161	20/03/00 00/00/00	
PR4	996014	RUOTA GIREVOLE D=80 SENZA FRENO REV. CASTOR D= 80 WITHOUT BRAKE	081 / 121 / 161	20/03/00 00/00/00	
PR5	996551	ASS.RUOTA ANTERIORE C/FRENO D=60 REVOLVING CASTOR ASS. D=60 WITH BRAKE	031 / 051	_/_/_- 00/00/00	
PR6	996552	ASS.RUOTA ANTERIORE S/FRENO D=60 REVOLVING CASTOR ASS, D=60 WITHOUT BRAKE	031 / 051	_/_/_- 00/00/00	
PR7	996540	RUOTA GIR D= 60 CROMATA CON FRENO REVOLVING CASTOR D= 60 CROMATE WITH BRAKE	031 / 051	_/_/_- 00/00/00	
PR8	996541	RUOTA GIR D= 60 CROMATA S/FRENO REV. CASTOR D=60 CROMATE WITHOUT BRAKE	031 / 051	_/_/_- 00/00/00	
PRS1	925557	SUPPORTO RUOTA D=80 TR H=150 CASTOR BEARING D=80 TR H=150	081 / 121 / 161	20/03/00 00/00/00	
PRS2	965373	PIASTRA SUPP.RUOTA ABB051 BEARING CASTOR PLATE B. CHILLER 051	031 / 051	_/_/_- 00/00/00	
PS	996583	PORTASTARTER PER LAMPADE FL HOLDER-STARTER DEVICE FOR TUBULAR LAMP	081 / 121 / 161	_/_/_- 00/00/00	
PSS	965285	PIASTRINA SUPPORTO SONDA SPILLONE BEARING HEARTH PROBE PLATE	GN	22/02/07 01/11/07	
Q1	995345	RELE' DI POTENZA 30A 250V POWER RELAY 30A 250V	031 / 051 / 081 / 121D	01/01/95 00/00/00	<input type="checkbox"/>
R1	965301	RESIS.CORNICE PO.ABB081 10W/M FRAME HEATER DOOR B.C. 081 10W/M	081	23/02/07 00/00/00	<input type="checkbox"/>
R1	965302	RESIS.CORNICE PO.ABB051 10W/M FRAME HEATER DOOR B.C. 051 10W/M	031 / 051	23/02/07 00/00/00	<input type="checkbox"/>
R1	965303	RESIS.CORNICE PO.ABB161 10W/M FRAME HEATER DOOR B.C. 161 10W/M	161	23/02/07 00/00/00	<input type="checkbox"/>
R1	996456	RESIS.CORNICE PO.ABB121 10W/M FRAME HEATER DOOR B.C. 121 10W/M	121	16/01/07 00/00/00	<input type="checkbox"/>
RC	996493	ROTOLO CARTA X STAMPANTE EVCO PM100AX9 ROLL OF PRINTER PAPER EVCO PM100AX9		02/03/07 00/00/00	
RL	965374	RICEVITORE LIQUIDO V=1,5 LIQUID RECEIVER V=1,5	161	_/_/_- 00/00/00	
RL	995161	RICEVITORE DI LIQUIDO 0,85 LITRI LIQUID RECEIVER 0,85 LITERS	121	01/01/95 00/00/00	
RL	995906	RICEVITORE DI LIQUIDO 0,58 LITRI LIQUID RECEIVER 0,58 LITERS	031 / 051 / 081	08/10/98 00/00/00	

referim. reference	codice code	descrizione description	modello model	da...a from...to	ricambi cons. rec. spare part
S	995851	STARTER PER TUBI AL NEON STARTER DEVICE FOR TUBULAR LAMP	081 / 121 / 161	14/09/98 00/00/00	
SB	965293	SUPPORTO BACINELLA RACC.CONDENSE ABB.051 CONDENSATE TRAY SUPPORT BLAST CHILLER 051	031 / 051	22/02/07 00/00/00	
SB	965470	SUPP.BACINELLA RACC.COND.ABB.081/121 CONDENSATE TRAY SUPPORT B.C. 081/121/161	081 / 121 / 161	_/_/_ 00/00/00	
SB1	965249	STAFFA SUPPORTO RACC.SCARICO ABB.051- 161 FRAME SUPPORT FOR JOINT DRAIN B.C. 051- 161		26/01/07 00/00/00	
SCE	965287	ASS. SCATOLA ELETTR. ABB.051 NEW ELECTRIC BOX BLAST CHILLER 051 NEW	031 / 051	_/_/_ 00/00/00	
SCE	965400	SCATOLA ELET.TRIFASE AB121-161 X FAST ELECTRIC BOX THREE-PHASE B.C. 121/161 FAST	121A / 161 FAST	_/_/_ 00/00/00	
SCE	965401	SCATOLA ELET.TRIFASE AB121-161 X PLUS ELECTRIC BOX THREE-PHASE B.C. 121/161 PLUS	121A / 161 PLUS	_/_/_ 00/00/00	
SCE	965402	SCATOLA ELET.MONOFASE AB081-121 X FAST ELECTRIC BOX MONO-PHASIC B.C. 081-121 FAST	081 / 121D FAST	_/_/_ 00/00/00	
SCE	965403	SCATOLA ELET.MONOFASE AB081-121 X PLUS ELECTRIC BOX MONO-PHASIC B.C. 081-121 PLUS	081 / 121D PLUS	_/_/_ 00/00/00	
SCE	965642	ASS.SCATOLA ELETTR.ABB BC051 ELECTRIC BOX BLAST CHILLER 051	BC051A	_/_/_ 00/00/00	
SPL	996270	INDICATORE LIQU. SGN 6S ODFXODM 014-02 LIQUID INDICATOR SGN 6S ODFXODM 014-02	031 / 051 / 081	07/09/04 00/00/00	
SPL	996271	INDICATORE LIQU. SGN10S ODFXODM 014-02 LIQUID INDICATOR SGN10S ODFXODM 014-02	121 / 161	_/_/_ 00/00/00	
SSE	965288	STAFFA DX-SX SUPP. EVAPORATORE ABB.051 RIGHT/LEFT FRAME EVAPORATOR SUPP. B.C. 051	031 / 051	_/_/_ 00/00/00	
SSE	965406	STAFFA DX SX SUPPORTO EVAP 081-121-161 RIGHT/LEFT FRAME EVAP. 081-121-161 SUPPORT	081 / 121 / 161	_/_/_ 00/00/00	
SST	965568	SCATOLA PER STAMPANTE ABB051 PRINTER BOX BLAST CHILLER 051		_/_/_ 00/00/00	
ST	996415	STAMPANTE PER SCHEDA EVCO PRINTER FOR EVCO CARD		03/11/06 00/00/00	
T	990319	TRASFORMATORE 230/24V 17VA 50/60HZ TRANSFORMER 230/24V 17VA 50/60HZ	BF	08/09/00 00/00/00	□
T2	995850	REATTORE PER NEON 15W BALLAST 15W	081 / 121 / 161	14/09/98 00/00/00	
TPS	965281	TAPPO PILETTA DI SCARICO ABS H=74 FLOOR DRAIN PLUG ABS H=74		22/02/07 00/00/00	
TS	965407	TUBO SCAMBIATORE BF051(+/-) EXCHANGER TUBE BF051 (+/-)	BF051_ / BF031A	_/_/_ 00/00/00	
TS	965408	TUBO SCAMBIATORE BC051(-) EXCHANGER TUBE BC051(-)	BC051D	_/_/_ 00/00/00	

riferim. reference	codice code	descrizione description	modello model	da...a from...to	ricambi cons. rec. spare part
TS	965529	TUBO SCAMBIATORE 161(BF+- BC+) BF122 EXCHANGER TUBE 161(BF+- BC+) BF122	BF161_ / BC161A	_/_/_ 00/00/00	
TS	965530	TUBO SCAMBIATORE 121(BF+) EXCHANGER TUBE 121(BF+)	BF121A	_/_/_ 00/00/00	
TS	965531	TUBO SCAMBIATORE 121(BF+ BC+-) EXCHANGER TUBE 121(BF+ BC+-)	BF121D / BC121D	_/_/_ 00/00/00	
TS	965532	TUBO SCAMBIATORE 081(BF+- BC+) EXCHANGER TUBE 081(BF+- BC+)	B_081A	_/_/_ 00/00/00	
TS1	996542	GUAINA SPIRALATA GRIGIA D=16 PVC AL M. GREY SPIRAL SHEATHING D=16 PVC		_/_/_ 00/00/00	
TS2	995512	RACCORDO DI SCARICO AP350 FLESSIBIL JOINT DRAIN AP350 FLESSIBIL	081 / 121 / 161	01/01/95 00/00/00	
TS2	996520	RACCORDO SCARICO 1'G ABB051 L=40CM JOINT DRAIN 1'G BC051 L=40CM	031 / 051	_/_/_ 00/00/00	
V1	995336	VALVOLA SOLENOIDE 1/4'A SILDARE 230V SOLENOID VALVE 1/4' TO SOLD 230V	051	_/_/_ 00/00/00	<input type="checkbox"/>
V1	995508	VALVOLA SOLENOIDE 3/8"A SILDARE 230V SOELNOID VALVE 3/8" 230V TO SOLD	081 / 121 / 161	_/_/_ 00/00/00	<input type="checkbox"/>
VCC	995932	ASS.VASCHETTA EVAPORA CONDENSA ABBATT. TRAY FOR CONDENSATION BLAST CHILLER		05/03/07 00/00/00	
VEC	965757	VASCHETTA R.CONDENSA ABB P700 RAL7012 EVAPORATOR TRAY CONDENS. BC P700 RAL7012	031 / 051	_/_/_ 00/00/00	
VEC	965758	VASCHETTA R.CONDENSA ABB P800 RAL7012 EVAPORATOR TRAY CONDENS. BC P800 RAL7012	081 / 121 / 161	_/_/_ 00/00/00	
VE	996206	VALVOLA TERMOSTATICA TS2 R404 A SILDARE THERMOSTATIC VALVE TS2 R404A TO SOLDER	BF031A / BF051_	18/03/03 00/00/00	
VE	996258	VALV.TES2 68Z3442 ODF -40-5 MOP 0 R4 VALVE TES2 68Z3442 ODF -40-5 MOP 0 R4	BC051_ / BC081-121-161A	07/09/04 00/00/00	
VE	996259	VALVOLA TES2 68Z3648 ODF -40-15 MOP-10 R4 VALVE TES2 68Z3648 ODF -40-15 MOP-10 R4	BF051-081-161A / BF121_	07/09/04 00/00/00	
W2	965433	KIT LAMP.UVC AB 051-081-121-161-122 RI UVC LAMP BC 051-081-121-161-122	081 / 121 / 161	_/_/_ 00/00/00	
W2a	995853	LAMPADA FLUORESCENTE GERMICIDA 15W FLUORESCENT GERMICIDAL LAMP 15W	081 / 121 / 161	14/09/98 00/00/00	
W2b	995852	TUBO PROTEZIONE LAMPADA GERMICIDA PROTECTIVE TUBE FOR GERMICIDAL LAMP	081 / 121 / 161	14/09/98 00/00/00	
W2c	965534	GRIGLIA PROTEZIONE LAMPADA GERMICIDA PROTECTIVE GRID FOR GERMICIDAL LAMP	081 / 121 / 161	_/_/_ 00/00/00	
W2d	995854	PORTALAMPADA PROTETTO X LAMPADA GERMIC BULB SOCKET FOR GERMICIDAL LAMP	081 / 121 / 161	14/09/98 00/00/00	

referim. reference	codice code	descrizione description	modello model	da...a from...to	ricambi cons. rec. spare part
W2e	965535	RACCORDO C/PRESSACAVO STAGNO X LAMP/GE PRESS-WIRE JOINT FOR GERMICIDAL LAMP	081 / 121 / 161	__/__/00 00/00/00	
XA	965525	MORSETTO PHOENIX MSTB 2,5/2-ST PAS=5 PHOENIX TERMINAL MSTB 2,5/2-ST PAS=5		__/__/00 00/00/00	
XB	965526	MORSETTO PHOENIX MSTB 2,5/3-ST PAS=5 PHOENIX TERMINAL MSTB 2,5/3-ST PAS=5		__/__/00 00/00/00	
XC	996591	MORSETTO PHOENIX MSTB 2,5/4-ST PAS=5 PHOENIX TERMINAL MSTB 2,5/4-ST PAS=5		__/__/00 00/00/00	
XH	965528	MORSETTO PHOENIX MSTB 2,5/8-ST PAS=5 PHOENIX TERMINAL MSTB 2,5/8-ST PAS=5		__/__/00 00/00/00	
Y1	996547	TERMICA MOELLER ZE 6,0 (4-6A) TELEMECANIQUE THERMAL ZE 6,0 (4-6A)	121A / 161	30/05/07 00/00/00	<input type="checkbox"/>