



## **Kühlschrank 700 I, GN 2/1, für Zentralkühlung mit Ventil R404**

Artikel-Nr.

90621063 (7F070RNC5P002 / ARTIC 700TN R R404)

---

### **Explosionszeichnung / Ersatzteile**

---

Bitte bei Ersatzteilbestellung immer Artikelnummer und  
Seriennummer mit angeben!

# **7F070RNC5P002-CABINET 70/90 TN REM. ARTIC/FROSTY**

*Content filters: validity 11/09/2018*

*11/09/2018*

7F070RNC5P002 - 7F070RNC5P002-CABINET 70/90 TN REM. ARTIC/FROSTY..... 3  
    7F070RNC5P002-OPT - EXPLODED VIEW OF OPTIONAL PARTS & FEATURES.....5  
    SC803 - ELECTRICAL WIRING..... 7  
Components index.....8

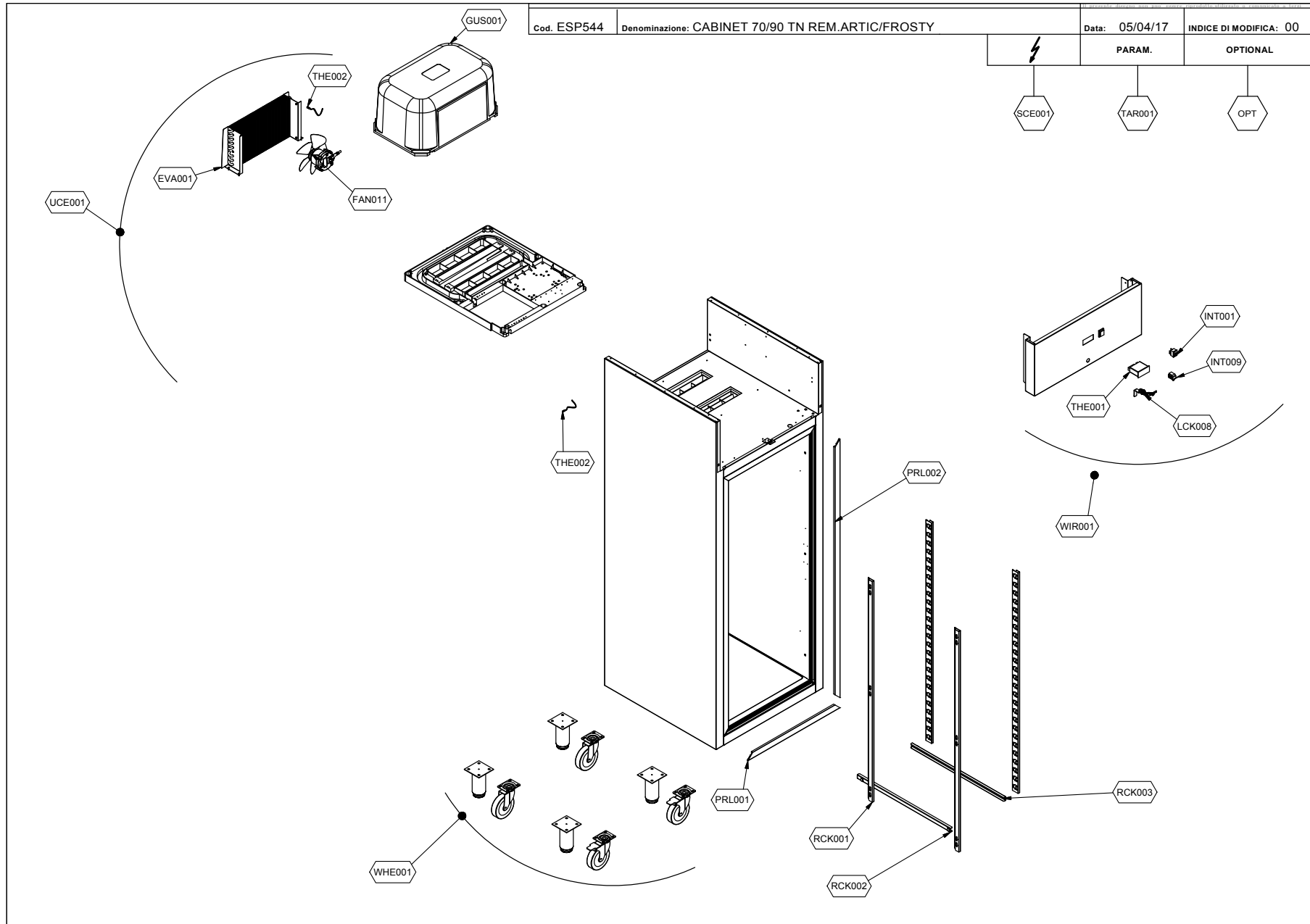



















7F070RNC5P002-CABINET 70/90 TN REM. ARTIC/FROSTY - Content filters: validity 11/09/2018

**7F070RNC5P002 - 7F070RNC5P002-CABINET 70/90 TN REM. ARTIC/FROSTY**







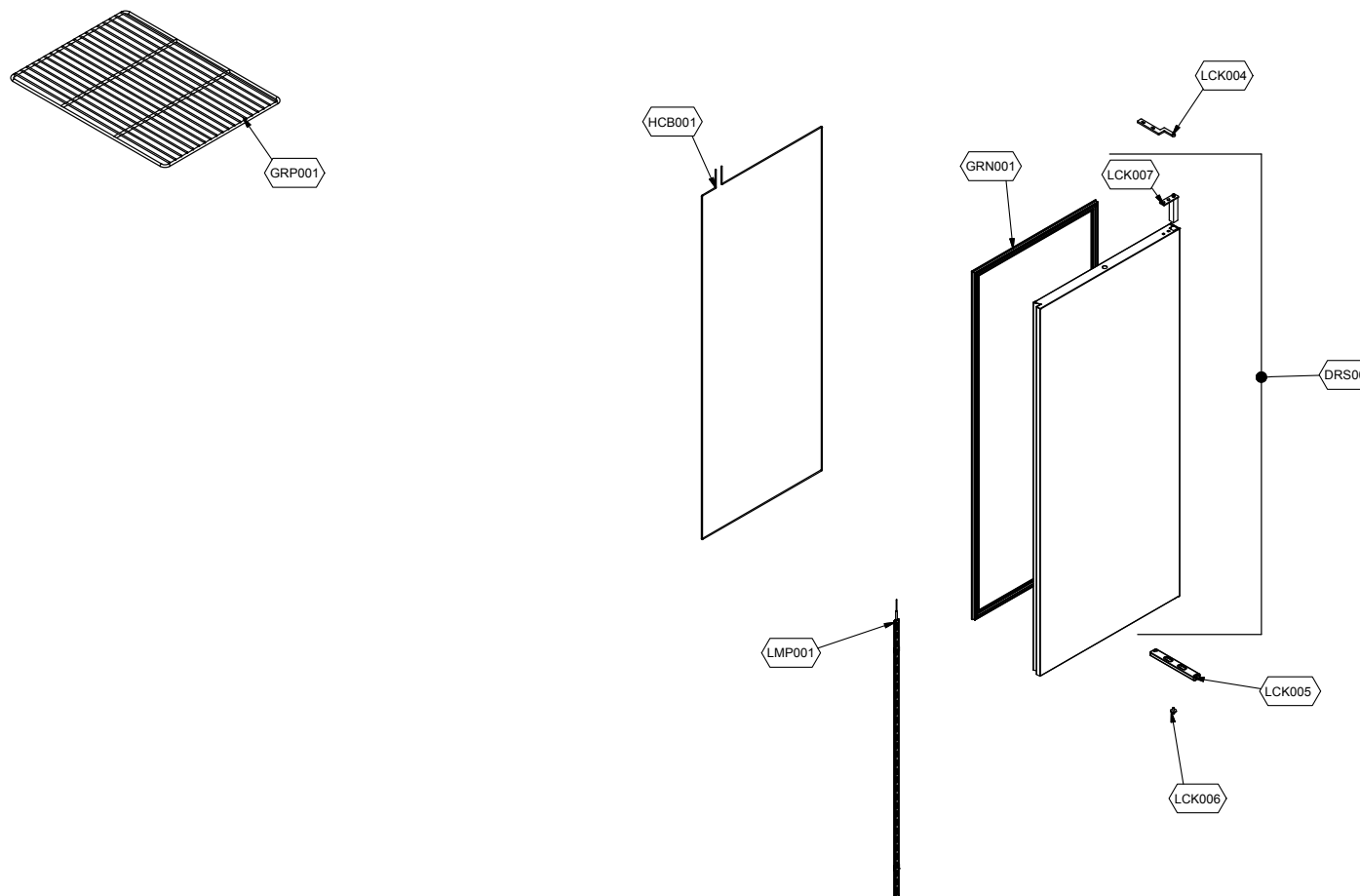

Validity: from 23/01/2018

11/09/2018

Page 3 / 8

Purch.	Pos.	Code	Q.ty	Description	Spare parts after year	Notes
	EVA001	74837306	1	EVAPORATOR	5	
	FAN011	73688646	1	KIT FAN	2	
	GUS001	74701641	1	WARM CABLE		
	INT001	74742008	1	MAIN ON/OFF SWITCH	2	
	INT009	78010438	1	MICROSWITCH	2	
	LCK008	73692124	1	LOCK		
	OPT	7F070RNC5P002- OPT	1	EXPLODED VIEW OF OPTIONAL PARTS & FEATURES		
	PRL001	72609622	1	MOBILE HORIZONTAL COVER		
	PRL002	72609626	1	MOBILE VERTICAL COVER		
	RCK001	74779100	1	UNIVERSAL RACK		
	RCK003	74703270	1	RIGHT RUNNER		
	RST001	74837334	1	HEATING ELEMENT	2	
	RST003	74837398	1	HEATING ELEMENT	2	
	SCE001	SC803	1	ELECTRICAL WIRING	1	
	TAR001	RIF.TAR.Q05	1	CONTROLLER PRESETTING SERVICE	1	
	THE001	74700776	1	UNSETTED ELECTRONIC CONTROLLER	1	
	THE002	74700917	1	PROBE	1	
	UCE001	74861162	1	FULL CONDENSING UNIT		
	WHE001	74702570	1	CASTOR/FEET		
	WIR001	73691820	1	ELECTRICAL PANEL		



Purch.	Pos.	Code	Q.ty	Description	Spare parts after year	Notes
	DRS001	73692252	1	DOOR		
	FAN009	73688646	1	KIT FAN	2	
	GRN001	74703386	1	GASKET	2	
	LCK005	74708202	1	LOWER DOOR SUPPORT		
	LCK006	74708126	1	BOTTOM HINGE		
	LMP001	74755590	1	LED LIGHTING		
	THE003	74701161	1	LED POWER PACK	1	
	WHE001	74702570	1	CASTOR/FEET		

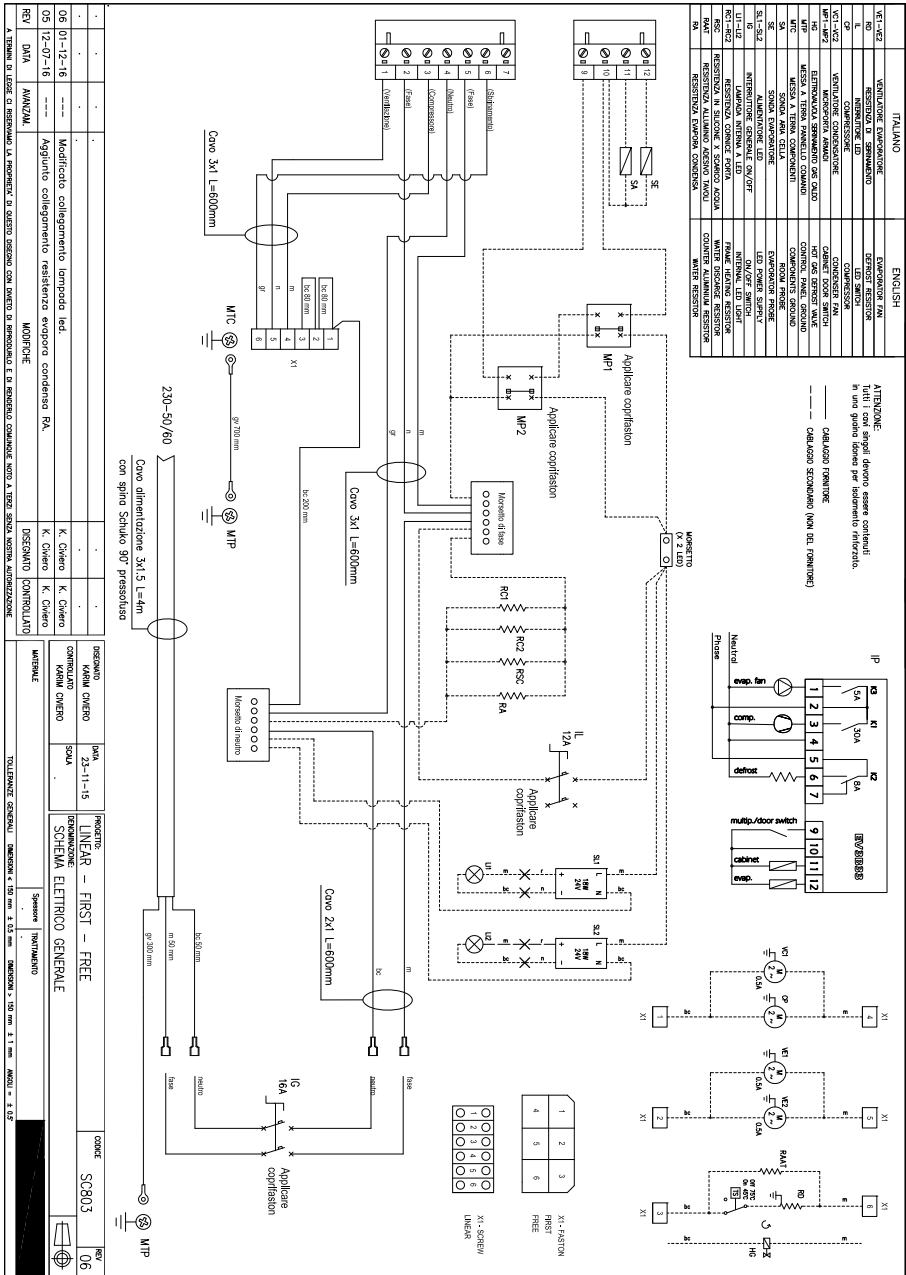



Code	Parts Table	Pos.	Q.ty
72609622	7F070RNC5P002	PRL001	1
72609626	7F070RNC5P002	PRL002	1
73688646	7F070RNC5P002	FAN011	1
	7F070RNC5P002- OPT	FAN009	1
73691820	7F070RNC5P002	WIR001	1
73692124	7F070RNC5P002	LCK008	1
73692252	7F070RNC5P002- OPT	DRS001	1
74700776	7F070RNC5P002	THE001	1
74700917	7F070RNC5P002	THE002	1
74701161	7F070RNC5P002- OPT	THE003	1
74701641	7F070RNC5P002	GUS001	1
74702570	7F070RNC5P002	WHE001	1
	7F070RNC5P002- OPT	WHE001	1
74703270	7F070RNC5P002	RCK003	1
74703386	7F070RNC5P002- OPT	GRN001	1
74708126	7F070RNC5P002- OPT	LCK006	1
74708202	7F070RNC5P002- OPT	LCK005	1
74742008	7F070RNC5P002	INT001	1
74755590	7F070RNC5P002- OPT	LMP001	1
74779100	7F070RNC5P002	RCK001	1
74837306	7F070RNC5P002	EVA001	1
74837334	7F070RNC5P002	RST001	1
74837398	7F070RNC5P002	RST003	1
74861162	7F070RNC5P002	UCE001	1
78010438	7F070RNC5P002	INT009	1
RIF.TAR.Q05	7F070RNC5P002	TAR001	1